

# Environmentally Sustainable Production Systems for Producing Ornamental Plants<sup>©</sup>

**John Bunker**

Redlands Nursery Pty. Ltd., 905-907 German Church Road, Redland Bay QLD 4165, Australia

## INTRODUCTION

Since man has been producing crops on earth there has been constant evolution adapting to changes, including demand for increased production to service population increases and other changes. These changes include intensive monoculture of crops, mechanization, new improved cultivars as a result of breeding and selection, to increase yields and to develop resistance to pests and include the discovery and the use of agricultural chemicals.

In the 21st century as horticultural producers we face the same global issues: pressure on margins, increasing legislative changes (which we need to adapt to) with regulatory requirements on occupational health and safety and environment. In addition there are the ever-changing demands in the marketplace both at consumer and commercial levels. At no other point has there been so much change.

Currently in the State of Queensland there is a major focus on the consumption of energy, water, and waste output with current population growth and development projections in southeast Queensland indicating power network supply difficulties by 2010 and water infrastructure without further expansion lasting until 2026.

At no other point has there been so much change or challenge. However in every challenge there lies an opportunity.

## THREAT OR OPPORTUNITIES

Each of these different areas can be viewed as a threat but importantly they are also opportunities that can shape our business into being leading-edge producers in the 21st century.

In the 1960s Dr. Ken Baker revolutionised the production of ornamental plants with his book, *The U.C. System for Producing Healthy Container Grown Plants*. This book described the benefits of using aerated steam for pasteurising growing media as well as the use of soilless potting mix. The Australian nursery industry embraced this document, which has become the basis of the production processes in a majority of nurseries. The nursery industry also commenced using waste products of the timber industry with the use of bark and sawdust.

In the Redlands Nursery case study, the last 20 years have been a constant evolution to today where the focus is on integrated crop management (ICM) using environmentally sustainable production systems focused on the triple bottom line.

A major focus of this approach is on hygiene so that we are preventing problems rather than trying to cure them chemically, this underlines the total system approach from weed management to water disinfection. This also includes membership of the Nursery Industry Accreditation Scheme (NIASA).

In embracing the triple bottom line our investment strategies and production processes all revolve around this, which means the following:

- People — provision of career opportunities and training as well as ensuring that the work place processes take into consideration health and safety of the workforce.

- Profit — return on funds invested with the objective of improving profitability and being able to reinvest in the business and stay competitive.
- Environment — all processes are environmentally friendly and adhere to or exceed any environmental legislation, as an example all equipment upgrades take into consideration power and fuel consumption.

### **INTEGRATED CROP MANAGEMENT**

Integrated crop management is a holistic approach to the production of crops. It encompasses the following major areas:

- Hygiene;
- Water;
- Nutrition;
- Planting material;
- Integrated pest management (insects, weeds, pathogens);
- Growing environment.

Plants are like people — both are living organisms and, to ensure peak performance, need to have all of these areas in balance.

### **HYGIENE**

In any production system hygiene is the most critical factor in the prevention of problems occurring rather than trying to cure problems chemically after the event.

Hygiene includes effective quarantine and monitoring of new plant material to ensure that you aren't bringing any new pests onto the property.

An effective weed management plan as weeds harbour insect pests' plant pathogens. For example flowering weeds close to the crop can host thrips, aphids, whitefly, and two-spotted mites. The removal of dead or diseased plant material to prevent spread of plant pathogens and sterilising used growing containers with aerated steam at 72 °C to prevent the possible spread of soilborne pathogens are important points of hygiene.

Keeping the production and propagation facilities clean all the time rather than trying to clean occasionally is more effective housekeeping and an important hygiene step as well as promoting a professional image.

People are important and the cleanliness of the team and equipment which takes into consideration issues such as smokers who are capable of spreading TMV onto susceptible crops underpin hygiene and quarantine.

### **WATER MANAGEMENT**

This is a continuing process of reviewing, recycling, and strategic application as it is a precious resource. Four years of below average rainfall created the opportunity to critically review the use of this important resource.

Our annual evaporation rate is 1.2 m with rainfall for the 2004 year being 1.32 m.

As a result, recycling of water became a necessity on the home property, as the site did not have any underground water supply only a dammed creek. Using the creek water resulted in losses caused by water borne *Phytophthora* or *Pythium*. In addition to chemical treatment of the crops sodium hypochlorite was recommended to disinfest the water supply. This eliminated the problem and was prevention rather than trying to cure the problem after the event chemically.

Water quality is also improved by using sand filtration and inline filters to remove organic matter and ensure that the disinfection process is most effective.

Regular monitoring of all water sources to manage pH, EC, and nitrates is vitally important. We aim for a pH of 6.5 down line solution as sodium hypochlorite solution reduces in effectiveness after pH 7.2.

The nursery runoff water is channelled back to separate collection dams where it is blended with other water sources to create our irrigation water.

Other water management strategies include the location of stockpiles of mulch, potting mix, and animal manures so that the leachate from these sources is adequately filtered before entering the recycled water supply.

**Application of Water.** Sprinkler technology matched to the requirements and growing facilities is a vital step in ensuring efficient use of water.

New technology has seen advances in different application techniques as well as upgrades of previous overhead sprinklers, which can increase water efficiencies. The Nelson rotator R 2000 has been used to replace conventional brass sprinklers and the following was achieved:

- Water saving 20%.
- Improved crop quality due to more even application when the sprinklers were fitted with pressure regulators.
- Sprinklers fitted with pressure regulators gained water saving at the beginning and end of the irrigation cycle with no drain down or the resultant crop damage under these sprinklers.
- More efficient water application results in savings in electricity, water treatment costs, and nutrition due to reduced leaching, crop health, which all ultimately affect the bottom line.

The use of variable speed drive pumps improves management of operating pressure for the sprinklers as well as flexibility when beds are partially shut down. The pump only pumps enough water for the sprinklers, which stops over pressurising causing broken or leaking water mains.

Variable speed drive pumps are also more energy efficient and this lowers running costs as well as water main maintenance.

The next stage in water management will be the use of aerators and biological bacteria in the recycling system to manage pH and algae bloom in the recycling ponds.

## **NUTRITION AND POTTING MIX**

Composting of the potting mix is a critical step in the nutrition process.

Over the last 20 years when initially we commenced using aging of sawdust as opposed to a dedicated composting process which included added nutrition and regular turning we have seen crop growth and quality improve with the reduced nitrogen drawdown.

Controlled-release fertiliser was used as a dibble that ensured each plant received the same amount of fertiliser in the root zone and where it received constant moisture and temperature.

Now we are applying irrigation water more effectively (reduction of up to 20% in water application rates) it has reduced leaching and some crops created excess nutrients that caused root burn, poor growth, and secondary disease infections. The initial reaction was to reduce the irrigation cycles further, which made the problem worse. Further testing showed the EC to be excessive so irrigation was increased to flush out the excess nutrients.

This season all controlled-release fertiliser is now incorporated in the mix; this has resulted in further reduction in water use, reduced crop losses, and better crop performance particularly of the woody ornamentals such as camellias, azaleas, and magnolias.

All potting mix is batch tested for air-filled porosity, water-holding capacity, pH, EC, and germination before use with pH being stabilised at 6.5. Regular full lab nutritional testing is also carried out by a professional consulting company.

Sand has been eliminated from the potting media as it was washed river sand, which intermittently tested positive for phythium.

Now the focus is use of the totally renewable products pine bark and coir peat.

Fertigation to fine tune the plant nutrition is managed using media testing and sap testing of the target crops to provide accurate real time crop data, ensuring optimum crop growth.

## PLANTING MATERIAL

Without quality planting material it is not possible to produce a quality-finished product.

A major step forward in ornamental production in the last 5 years has been the availability of virus-indexed plant material as mother plants.

European and North American cuttings are produced in specialised quarantined clean houses and are then shipped to rooting stations to create plugs, which can be shipped to the producers for finishing. This has resulted in a major change in production techniques and improved crop growth and health.

High quality well maintained healthy stress-free mother plants whether in conventional propagation systems or the new high health systems are still the critical first step in a successful production cycle.

## INTEGRATED PEST MANAGEMENT

Integrated pest management (IPM) was first practiced at the Redlands in the 1980s as a result of difficulty in managing two-spotted mite (TSM) populations built up on neighbouring tomato growing properties with the only sustainable way to produce, *Chamaedorea elegans* in particular was to look at alternative methods rather than the traditional use of pesticides as we were not achieving satisfactory control. The predator used was *Phytoseiulus persimilis*. The challenge was to research the pest and the predator to understand the lifecycles of both friend and foe, also understanding the environment required by the predator. This resulted in the introduction of a humidity cycle in the middle of the day, to enhance the predator's reproductive cycle at the expense of the TSM, which prefers hot dry conditions.

Other successful uses of biocontrols have included the use of nematodes applied as a drench for the management of fungus gnats and the use of *Cryptolemus* beetle for managing mealy bug.

With ICM the application of pesticides is only one management tool and part of the whole crop production strategy.

Weekly crop monitoring by dedicated professionally qualified personnel combined with feedback from the production team gives real time information of what is happening.

Traditionally all pesticides were applied on a calendar basis, now pesticides are applied on a needs-only basis which reflects pest populations as well as stages in pest life cycles.



Some fungicides are still applied on a calendar basis to foliage crops in periods of high rainfall and humidity or flowering crops such as azaleas during their peak flowering stage.

For effective pest management strategies to be implemented timing is critical as well as understanding the pests cycles.

For the management of *Heliothis*, monitoring egg lay we have been able to achieve total control of the 1st instar stage with the use of Bt plus mobait an attractant within 12 h of recording egg lays.

Waiting until the larvae are 2nd or 3rd instar requires the use of more potent pesticides as well as more applications often with mixed results.

The understanding of the insect pest life cycle or the best conditions for plant pathogen development means that the environment can be modified further preventing possible outbreaks of disease. For example keeping the crop dry into the evening helps prevent the spread of a lot of fungal leaf diseases as well as botrytis on flowering crops particularly in cooler conditions.

The successful use of the new oil-based pesticides is totally dependent on timing of the applications to the correct life stage of the pest's life cycle for effective prevention of problems.

**Application Techniques.** Traditional use of high volume application technology of 2000 L·ha<sup>-1</sup> and applying the spray to run off was accepted as the norm. This resulted in mixed results as well as excessive time particularly if being applied by hand.

Currently application rates have been reduced to 250 L·ha<sup>-1</sup> and treating 2 ha·h<sup>-1</sup> using airshear sprayers.

We now have more effective control of the application as the small droplets produced by the airshear sprayer and carried by the turbulence created by the machine are deposited on both the upper and lower sides of the target leaves and stems throughout the crop.

Of particular interest since using this technology is the increase in populations of eastern water dragons as well as the insect eating blue fairy wrens, which actually nest successfully in the crop. This wildlife is playing an effective bio control role of certain insect populations.

This demonstrates that we are able to work with nature and also how the approach of change to low-volume application coupled with spot spraying and use of (softer) pesticides is having a positive effect on the natural ecosystem.

**Alternative Pest Management Techniques.** We will continually support research or experiment with the use of alternative chemicals, and biocontrols, as well as other pest management strategies. The total approach to pest management is science based and not muck and mystery.

**Use of Insect Traps.** For example, insect traps killing the adults effectively stop them laying eggs, which then turn into larvae, which can ultimately damage the crop. Insect traps can be an important tool in monitoring what insect populations are present, acting as an early warning system. The majority of the caterpillar pest problem is related to moths, which are all night flying and are able to be caught using attractant lights and insect traps.

## **GROWING ENVIRONMENT**

The correct growing environment for the crop is not only critical in producing a healthy product but also important in reducing pest problems. Researching where the crop grows in its natural environment provides important facts for matching water requirements, nutrition, and temperature and light levels required for optimum crop performance.

It is also important to research the environmental factors that favour pests as this can also influence selection of the growing environment. For example TSM thrive in hot dry conditions, roses produced under drip irrigation can be more susceptible to TSM and it maybe difficult to establish predator mites compared to situations where roses are produced under overhead sprinkler irrigation.

Good air movement and crop spacing are important cultural factors in the prevention of the spread of disease; it also helps to keep the crops foliage dry.

The Nursery Industry Accreditation Scheme of Australia (NIASA) focuses on best practise production techniques with a strong focus on the growing environment, including light and humidity, the maintenance and management of the facility, air movement, and ventilation. Management of wind, cultural controls, and hygiene are also important facets of the growing environment considered for the NIASA Accreditation Scheme.

Producing on benches or gravel beds to provide good drainage away from the container or rain splash onto the crop are also critical steps in prevention of disease spread.

## **MULCHING**

This is an effective use of green waste produced on the property and then processed through aging or composting.

Mulching of field-grown stock and garden beds not only improves soil health and encourages surface feeder roots but also is an effective weed management strategy as well as insulating the soil keeping it cooler in summer and warmer in winter.

Mulching is also important in water management locking in soil surface moisture after rainfall or irrigation which other wise would be lost through evaporation.

For field production the use of green manure crops for fallowing the soil reduces the risk of soil erosion in a high rainfall area and is important in building up the organic matter and organic carbon content of the soil and feeding the soil microflora. Forage sorghum is used in the summer months coupled with oats in the cooler months as effective green manure crops.

## **WASTE GENERATION**

In some countries the manufacturer who creates the packaging has to have in place a waste disposal system. This has resulted in packaging, which is recyclable from manufacturing of luxury cars to household consumables.

Ultimately the goal is the reduction of the amount of waste that is going into landfill.

The catch cry of reduce, reuse, and recycle is driving Australia in areas from water to energy to waste management.

In southeast Queensland current population projections indicate we will run short of power in 2010 and water in 2026.

Better use of these resources is seen as critical in the environmentally sustainable future for our communities.

**Waste Disposal and Recycling.** At Redlands the old potting mix is aged then incorporated with topsoil, which is then enriched with green manure crops and has its nutrition balanced. This value added product is then marketed through our local landscape yard as a value added garden soil.

Prunings or green waste, which had been traditionally burnt can be aged or composted and used as mulch for garden beds or field production.

Recycling of cardboard, paper, some plastics, and steel have well established programs available in most communities which saves them going into landfill and being remade into other usable products.

**Packaging.** Using packaging, which is recyclable or returnable is an important step in reducing material going into landfill. This may be in the form of returnable plastic trays, crates, bins, or trolleys.

The nursery industry has traditionally used waxed trays, which are not recyclable and go to land fill which is a cost to the community.

## FUTURE

The world around us is changing rapidly with concern about global warming, changing of weather patterns, and consumption patterns of resources such as water, fuel, and energy as populations continue to grow.

The Kyoto protocol, which comes into effect on 16 Feb. 2005 is an initial step in setting carbon emission targets and opens up the opportunity for carbon trading.

As we growers of plants produce clean air machines will we be able to take advantage of carbon trading and linking with companies who have emission issues. It certainly is an opportunity for the future.

As environmentally sustainable producers the triple bottom line will be the focus of our business in managing costs and key resources especially energy, water, and waste. In producing crops we will have to carefully consider the energy and water consumption of crops along with their profitability.

Environmentally sustainable developments in commercial and residential developments will in the selection of landscaping not only look at landscapes that use water efficiently but are also energy efficient. For instance the selection of trees to shade buildings in summer and let light in the winter reducing energy cost of heating and cooling respectively.

People will remain the key in both having qualified trained people to use and understand the new technologies and techniques, which will be adapted to crop production. Managing the systems and the information that they deliver will be the difference between success and failure.

## CONCLUSION

We have found our new approach of scientifically based, ecologically compatible production to be stimulating, sustainable, and profitable. The opportunities for our industry and as members of IPPS are exciting as we move into this new era of the 21st century. We have unique opportunities, the products we produce are not only important for man's survival in the production of food and future shelter (in timber production) but also they enhance the environment removing CO<sub>2</sub> and produce vital supplies of oxygen.

Ultimately we must all contribute to enhancing the environment and making the world a more beautiful and better place to live.

We wish you well in your quest for a better future for your community and mankind in general.

## Protection of Plant Novelties — An Update<sup>®</sup>

Jørgen H. Selchau

GPL International as, Lavsenvænget 18, Odense V, DK-5200, Denmark

### GOOD MORNING!

First of all, on behalf of the International Board of Directors, I want to congratulate the Southern Africa Potential Region with their success. I was personally honoured to participate in the inaugural conference and tours in November 1997. I was happy to be back again at the Conference in 2000 and have since — both as a member of the Southern African Potential Region and during the International Board Meetings — been admiring the enthusiasm and energy that has been provided by present and former members of the Board of Directors, the officers, and the local members, and I wish you every success in achieving full regional membership of our fabulous Society. We would all appreciate to SEEK and SHARE with you!

I also thank the organizers for once more inviting me back to present this paper here at the Potential Region's 8th Conference. I apologize that it is indeed some "boring legal stuff," but hopefully you will stay awake anyway!

During the early correspondence with the organizers, it was suggested to give the presentation a "Southern hemisphere or indigenous twist," and from the first announcements, I realized that a guy with a name quite similar to mine, coming from Sweden, was supposed to talk on that specific subject.

Consequently, I changed the title of my paper to "Protection of Plant Novelties — An Update," and I will be dealing with the issues of "Management of Intellectual Property Rights — Plants and Plant Biotechnology."

### PLANT VARIETY RIGHTS

English terminology often uses the abbreviations PVP (Plant Variety Protection), PVR (Plant Variety Rights), or PBR (Plant Breeders' Rights), which is a protection offered by means of either a national or territorial legislation of plant novelties or breeders' rights.

Most of the existing PVR systems are based on one of the versions of the International Union for the Protection of New Varieties of Plants Convention (UPOV). The UPOV is an intergovernmental organization with headquarters in Geneva (Switzerland). The first Convention adopted by this organization dates from 1961. It was revised in 1972, 1978, and 1991. UPOV has at the moment 55 members, of which Singapore is the latest one.

Other recent member states in Asia are China, Japan, the Republic of Korea, and Kirgizistan. Many countries in the world have adopted PVR legislation, which — although partly inspired by it — is not in all aspects in conformity with the UPOV system.

The subject matter of a UPOV-type plant breeders' right is a plant variety, which is defined by Article 5 of the UPOV 1991 Convention:

*"A plant grouping within a single botanical taxon of the lowest known rank, which grouping, irrespective of whether the conditions for the grant of a breeder's right are fully met, can be defined by the expression of the characteristics resulting from a given genotype or combination of genotypes;*

*distinguished from any other plant grouping by the expression of at least one of the said characteristics; and considered as a unit with regard to its suitability for being propagated unchanged.”*

In order to be eligible for protection a variety has to be **new, distinct, uniform,** and **stable**.

## **PATENTS**

The classical definition of a patent is referred to in Article 27 of the TRIPs (Trade-Related Aspects of Intellectual Property Rights) agreement: “patents shall be available for any invention ... provided that they are new, involve an inventive step and are capable of industrial application ...”

## **BIOTECHNOLOGY**

There is no internationally accepted legal text defining the notion of “biotechnology.” When you try to find a definition on the Internet many options are offered. For the purpose of this paper I would define “biotechnology” as follows: “The use of biological processes to create (improved) products considered to be useful and/or of economical value.”

Early biotechnology includes traditional plant breeding techniques. Modern biotechnology includes the industrial use of recombinant DNA and cell fusion.

## **INTELLECTUAL PROPERTY RIGHT**

In my presentation I would like to concentrate on the issues in respect of protection of plants or plant varieties, including biotechnological inventions by means of an intellectual property right as well as a comparison between the scope of protection offered by a plant variety right and a patent right respectively.

**Plant Breeders’ Rights.** “Plant inventions” and plant varieties can in most countries be protected under patent law and plant variety rights law, respectively.

As follows from article 52(b) of the European Patent Convention, to which a large majority of European countries are a contracting party, plant varieties are excluded from patent protection.

The scope of the exclusion from patentability has not only been subject to jurisprudence, but the European Community Biotech Directive also contains a provision meant to clarify the demarcation line between nonpatentable subject matter and “inventions which concern plants...” Such inventions “may be patented if the application of the invention is not technically confined to a particular plant...variety.”

The decision of the Enlarged Board of Appeal of the European Patent Office (EPC) in the *Novartis* case can be summarized as follows: “A claim wherein specific plant varieties are not individually claimed is not excluded from patentability under Article 53(b) EPC, even though the claim may embrace one or more varieties not specified.”

This is why a patent can be granted under the EPC when a claim relates to plants that can be part of an indefinite number of plant varieties.

**The Scope of Protection Offered by Patents and PVRs Respectively.** The rights provided by a plant variety right, UPOV type, and a (utility) patent are quite similar, as can be seen from this table which compares the scope of protection of a PVR and a patent as laid down in the UPOV Convention and the TRIPS agreement respectively.

TRIPS Agreement	UPOV
(Article 28)	(1991 Act – Article 14)
“1. A patent shall confer on its owner the following exclusive rights: (a) where the subject matter of a patent is a product, to prevent third parties not having the owner’s consent from the acts of:	“(1) [Acts in respect of the propagating material] (a) Subject to Articles 15 and 16, the following acts in respect of the propagating material of the protected variety shall require the authorization of the breeder
Making, Using,	(i) production or reproduction (multiplication) (ii) conditioning for the purpose of propagation
Offering for sale,	(iii) offering for sale
Selling, or	(iv) selling or other marketing
Importing	(v) exporting
For these purposes that product;”	(vi) importing (vii) stocking for any of the purposes mentioned in (i) to (vi), above.”

Although the rights resulting from the two intellectual property right systems do not differ much, it is generally accepted that patents offer a stronger protection than plant variety rights. The reason is that the plant breeders’ right does not extend to acts done for experimental purposes and acts done for the purpose of breeding other varieties, the so called breeders’ exemption, whilst such an exemption does not exist to the same extent in the patent systems in Europe and the U.S.A.

The clear demarcation line between the scope of the patent and PVR system has in Europe had the effect that in principle, only the results of modern biotechnology are subject of European patent applications. Especially gene sequences, which code for specific characteristics such as resistances against pest or tolerance to herbicides, and the techniques to introduce the sequence in plant material, are protected by patents. Such inventions could be applied in respect of an indefinite number of plant varieties and are for that reason not excluded from patentability under article 53(b) of the EPC.

The objects of PVR protection, new varieties of plants, are mostly the result of the application of traditional breeding techniques. Only in a few cases has the CPVO received applications for plant variety right protection in respect of genetically modified varieties.

In practice the coexistence of these two Intellectual Protection Rights systems available for the protection of the results of biotechnology, early and modern, does not create too many problems. In theory a conflict could arise when a plant variety is at the same time covered by a PVR, for the variety as such, and a patent, for a component of the variety, for instance a gene sequence. In such a situation the variety can only be commercialized with the authorization of the two right holders. The Biotech Directive contains a provision that if one of the right holders prevents the other from exploitation of his invention/plant variety a compulsory exploitation license could be granted, albeit only if certain quite restrictive criteria are fulfilled. Since 2000, specific clauses in respect of such compulsory licenses have been incor-

porated in the Danish legislation, i.e., Law on Plant Novelties and Law on Biotechnological Inventions.

In reality, the question of access to genetic resources as well as the right to breeding (Breeders' Exemption) will only be actual in the following situations:

***Access to Plant Varieties Protected by Patent.*** This is a case mainly occurring in the U.S.A. and, in fact, little formal discussion has officially taken place. However, a few companies consider the research-exemption is too narrow and that some flexibility should be given for specific breeding purposes.

***Access to Plant Varieties Protected by PVR.*** Through valid national and territorial PVR legislation, the protected plant material is freely available for further breeding purposes, however regulated through the provisions of Essentially Derived Varieties (EDV) in the latest UPOV-Convention.

The objective of this concept was to discourage the plagiarism and "easy breeding" made possible due to the difficulty of defining the necessary "minimum distance" for declaring a new variety distinct from other varieties of common knowledge.

Technically, for a variety to be considered an EDV, it must fulfill together three requirements in relation to the initial variety:

- Clear distinctness in the sense of the UPOV Convention.
- Conformity to the initial variety in the expression of the essential characteristics that result from the genotype or combination of genotypes of the initial variety (IV).
- Predominant derivation from the IV.

Legally speaking, concerning dependency — I:

- The IV must be a protected variety.
- Dependency can only exist from one single variety.
- An EDV can be directly derived from the IV or from a variety that is itself essentially derived from the IV. It is possible to have a "cascade" of derivation; however, each EDV shall only be dependant on one, the protected IV.

Legally speaking, concerning dependency — II:

- According to the general rule of burden of proof, the owner of the IV must prove essential derivation and then claim dependency. However, if the owner of the IV can give reasonable evidence of essential derivation (first by finger printing) the proof of non-predominant derivation should fall on the breeder of the putative EDV.

There is — so far — no jurisprudence on essential derivation, but to my knowledge a number of cases have been solved amicably using the prima facie proof.

It must also be noted, that the introduction of the concept of EDV has certainly changed breeding schemes and consequently "close" breeding is becoming rare — much to the benefit of breeders and the diversity of plant varieties at the disposal of growers.

***Access to Plant Varieties Protected by PVR and Containing Patented Elements.*** This is most probably the most controversial issue on intellectual property. According to the patent system, an approval from the holder of right is necessary to exploit the variety in question for further breeding purposes, whereas the Plant Variety Rights legislation is approving this on specific conditions.



In this respect, the International Seed Trade Federation (ISF) adopted a position paper during the Congress in Bangalore, India in June 2003: ***“ISF considers that Breeder’s Right (and patent for plant varieties where allowed by law) and patent protection for biotechnological inventions, are efficient protection systems. It is thus necessary to define a fair coexistence of the two rights.***

*The introduction of the concepts of essential derivation and dependency in the 1991 Act of the UPOV Convention is a welcome initiative to bridge the two systems, in the interest of all the actors involved.*

*However further clarification is needed as regards the use of transgenic varieties containing patented elements and protected by Breeder’s Right for further breeding.*

*ISF is strongly attached to the breeder’s exception provided for in the UPOV Convention and is concerned that the extension of the protection of a gene sequence to the relevant plant variety itself could extinguish this exception.*

*Therefore ISF considers that a commercially available variety protected only by Breeder’s Rights and containing patented elements should remain freely available for further breeding.*

*If a new plant variety, not an essentially derived variety resulting from that further breeding, is outside the scope of the patent’s claims, it may be freely exploitable by its developer.*

*On the contrary, if the new developed variety is an EDV or if it is inside the scope of the patent’s claims, a consent from the owner of the initial variety or of the patent must be obtained.*

*ISF is not generally in favor of compulsory licensing. Unrestricted compulsory licensing would make meaningless the new concept of dependency as well as the protection by patent on “biotechnological inventions.” ISF acknowledges the principle of compulsory licensing in case of public interest as provided for in patent laws. ISF has also considered the concept of compulsory licensing in case of “significant technical progress of considerable economic interest,” as provided for in the European Directive for the protection of biotechnological inventions and which is in line with the provision of the TRIPs agreement. However, the implementation of such a clause would have to be left to courts and thus be time-consuming and expensive.*

***ISF considers that in any case, the best solution is to encourage contractual voluntary licensing for both essentially derived varieties and patented traits.”***

The progress in genetic engineering raises the prospect that, in the foreseeable future, an ever-increasing number of plant varieties will contain patented inventions. The practical consequence would be that unless modifications in the patent legislation are introduced both the breeders’ exemption and, in the U.S.A. situation, the farmers’ privilege would be lost or greatly weakened. Article 30 of the TRIPs agreement offers a basis for such modifications: *“Members may provide limited exceptions to the exclusive rights conferred by a patent provided that such exceptions do not unreasonably conflict with a normal exploitation of the patent and do not unreasonably prejudice the legitimate interests of the patent owner; taking into account of the legitimate interests of third parties.”*

## CONCLUSION

In conclusion, it should be emphasized that the breeders’ exemption is considered as an essential element of the UPOV intellectual property rights system, since:

*“– it recognizes that real progress in breeding relies on access to the latest improvements and new variation.”*

*– and furthermore,*

*“Access is needed to all breeding materials in the form of modern varieties, as well as land races and wild species, to achieve the greatest progress and is only possible if protected varieties are available for breeding.”*

---

## Water Recycling: How We Do It<sup>®</sup>

### Eebie Deckys

Alstonville Palms, Weis Lane, Alstonville, NSW, 2477 Australia

Our family owns and operates a foliage nursery in subtropics on the east coast of Australia. We have been on a 10-year journey building a new nursery and learning how to recycle water. Our local agriculture department has given us a lot of support in water efficiency, but to a large extent, we were pioneers in setting up a water recycling system 10 years ago. During this presentation I'll take you through the steps we went through along the way. Quite a few things had to be added to solve problems that were unforeseen at the beginning.

The site we chose to set up our nursery is 12 ha. The production area is located on a gentle slope all running down to the catchment dam. We are blessed with an average annual rainfall of 1600 mm mainly falling in the first half of the year. The creek flowing through the property is unreliable, and the underground water supply also proved unreliable. Water recycling was the answer. It seemed to be very expensive at the time, but all water users in Australia and around the world are being forced to reduce water consumption and return rivers to their original flows. Our system has minimal effect on the environment and gives us a secure water supply.

Water is reused many times in our closed system. Water is added to the system when it rains and is lost through evaporation. In dry years we may top up our dams from the creek with 3 or 4 megaliters (ML). We have managed only on the bottom 6-ML dam. Between the two dams we have 17 ML of water storage. Water quality is much easier to manage with two. Water treatment is expensive so we decided we needed to use as little water as possible to water our plants so water efficiency was the first issue we tackled. We have also chosen a lot of low-water-usage crops. Initially, we began with one filter, a chlorine injection system, one tank, and a couple of small irrigation controllers. Over 10 years we have added a lot of extra pieces to make the system work (Fig. 1).

The main difference in our production areas is the way we have constructed the floors (Fig. 2). All beds are lined with builder's plastic. Over this, agricultural drainage pipe and 75 mm of blue metal was laid. We chose to cover the gravel with weed mat to minimize weeds and reduce the amount of organic matter getting into the system.

Extensive earth works were done to get the falls correct. Irrigation mains and electricals were all installed first. The builder's plastic all went down next using duct tape to seal all joins and seal up around mains and supports in the structure. Next came the 100-mm agricultural pipe that was installed in the drains that are in the middle of the roads. At the end of the shade house we convert this to large PVC pipes. Small lateral PVC pipes, risers, and supports for the irrigation risers were installed above the plastic. Boards (75-mm) were used to screed the gravel to a consistent depth. Last step was to fix the weed mat, which we have held down with gravel.

*“– it recognizes that real progress in breeding relies on access to the latest improvements and new variation.”*

*– and furthermore,*

*“Access is needed to all breeding materials in the form of modern varieties, as well as land races and wild species, to achieve the greatest progress and is only possible if protected varieties are available for breeding.”*

---

## Water Recycling: How We Do It<sup>®</sup>

### Eebie Deckys

Alstonville Palms, Weis Lane, Alstonville, NSW, 2477 Australia

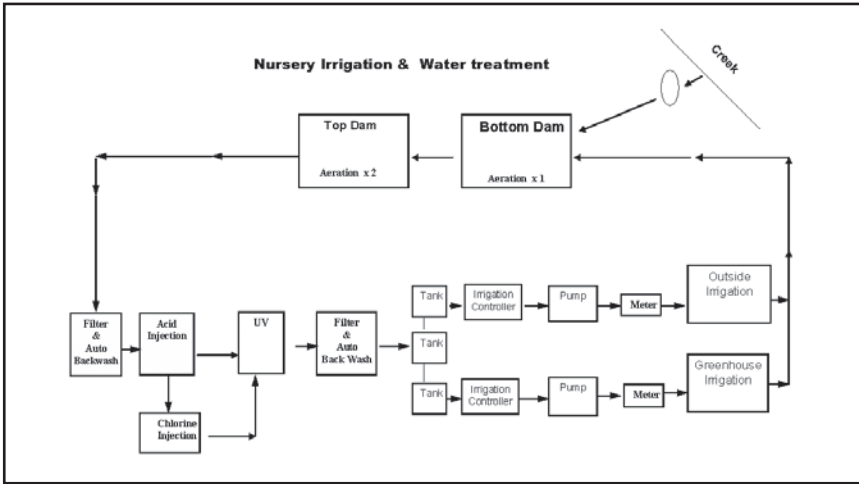
Our family owns and operates a foliage nursery in subtropics on the east coast of Australia. We have been on a 10-year journey building a new nursery and learning how to recycle water. Our local agriculture department has given us a lot of support in water efficiency, but to a large extent, we were pioneers in setting up a water recycling system 10 years ago. During this presentation I'll take you through the steps we went through along the way. Quite a few things had to be added to solve problems that were unforeseen at the beginning.

The site we chose to set up our nursery is 12 ha. The production area is located on a gentle slope all running down to the catchment dam. We are blessed with an average annual rainfall of 1600 mm mainly falling in the first half of the year. The creek flowing through the property is unreliable, and the underground water supply also proved unreliable. Water recycling was the answer. It seemed to be very expensive at the time, but all water users in Australia and around the world are being forced to reduce water consumption and return rivers to their original flows. Our system has minimal effect on the environment and gives us a secure water supply.

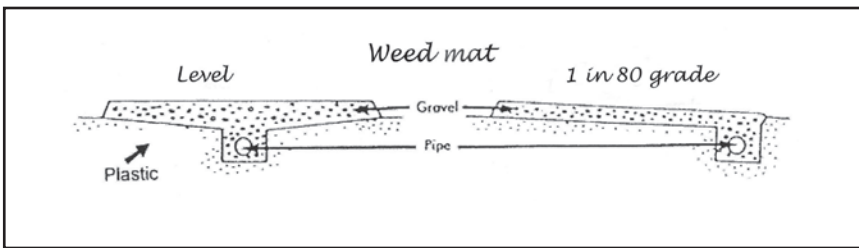
Water is reused many times in our closed system. Water is added to the system when it rains and is lost through evaporation. In dry years we may top up our dams from the creek with 3 or 4 megaliters (ML). We have managed only on the bottom 6-ML dam. Between the two dams we have 17 ML of water storage. Water quality is much easier to manage with two. Water treatment is expensive so we decided we needed to use as little water as possible to water our plants so water efficiency was the first issue we tackled. We have also chosen a lot of low-water-usage crops. Initially, we began with one filter, a chlorine injection system, one tank, and a couple of small irrigation controllers. Over 10 years we have added a lot of extra pieces to make the system work (Fig. 1).

The main difference in our production areas is the way we have constructed the floors (Fig. 2). All beds are lined with builder's plastic. Over this, agricultural drainage pipe and 75 mm of blue metal was laid. We chose to cover the gravel with weed mat to minimize weeds and reduce the amount of organic matter getting into the system.

Extensive earth works were done to get the falls correct. Irrigation mains and electricals were all installed first. The builder's plastic all went down next using duct tape to seal all joins and seal up around mains and supports in the structure. Next came the 100-mm agricultural pipe that was installed in the drains that are in the middle of the roads. At the end of the shade house we convert this to large PVC pipes. Small lateral PVC pipes, risers, and supports for the irrigation risers were installed above the plastic. Boards (75-mm) were used to screed the gravel to a consistent depth. Last step was to fix the weed mat, which we have held down with gravel.



**Figure 1.** The recycling system at Alstonville Palms.



**Figure 2.** Floor construction in our production areas.

Large PVC pipes take the water down the hill to the catchment dam. Smaller pipes down to 100-mm were used in collection areas and up to 225-mm pipes were used in high flow areas at the bottom of the hill. Concrete junction boxes join up all the pipes. Later we started to use plastic junction boxes that were much cheaper. These were plumbed so that silt would gather at the bottom for easy cleaning. The whole system was designed to take rainfall of 100 mm in 1 h.

The dams in our area need to be lined because our volcanic soils won't hold water. We have used 500- $\mu$ m dam liner plastic. We catch all our rainfall in our production areas, and the dam has only overflowed twice in 10 years. We try to limit the contaminants such as fertilizer, pesticides, herbicides, and organic matter getting into the catchment dam.

The biggest challenge for any recycling system is how to clean up the water suitable for irrigating. Algal blooms are the biggest enemy. They block irrigation, upset pH, and make it impossible to kill pathogens. We tried killing them with chelated copper, but we were treating them many times in hot weather. After about 3 years we ended up with 1 m of mud on the bottom. We discovered there were many layers in a dam. In early spring and early autumn, when temperatures in the dam were changing, the whole dam rolled over. The foul-smelling mud then came to the top

making it almost impossible to filter out.

We were having so much trouble with algal blooms the decision was made to install aerators in the dams. Aerators combine with friendly microorganisms that like to eat algae and keep the population to a minimum. Extra oxygen improves conditions for the microorganisms, and the algae seem to dislike it. The layers in the dams were all stirred up. The dams no longer rolled over because the layers had disappeared.

Filters and automatic backwash have been installed both at the beginning and at the end of the cleanup process. Manual backwash was installed initially but we were not doing the backwash often enough so eventually we automated it.

The pH is corrected with the addition of hydrochloric acid. We try to keep it at 6.5. When we were having large algal problems the pH of the dams soared to 9.7, but with the aerators, very little correction is required.

UV treatment is an easy way to kill pathogens. The cost to run and maintain is very small although the initial cost is substantial. The only restriction is you need clear water for the unit to work.

After UV treatment we do a final filter of the water before it goes into the holding tanks ready for use. The final filter was necessary because algae was killed in the UV treatment and clumped together. These large clumps blocked our drippers. We have 60,000 L of clean water ready to use.

Pumps and irrigation controllers are used to irrigate in the morning for all overhead irrigation of smaller stock. Drippers are used mostly in the afternoons and evenings. We group plants with similar water requirements together and use the minimum amount of water.

## TASKS

**Daily Tasks:** measuring rainfall, water usage, and evaporation pan. The reading is transferred to the irrigation controller. A crop factor is used to give the necessary amount of water to fill the containers in each station.

**Weekly Tasks:** pH, E.C, chlorine ppm when in use.

**Annual Tasks:** Water quality tested by laboratory with plant pathogen check.

### Routine Maintenance:

- Flush irrigation lines with chlorine every 6 weeks in summer.
- Large containers on drippers fully checked at start of each crop.
- Each morning check UV, acid, and chlorine if in use.
- Check block pressures and sprinkler and dripper performances.

## ADDITIONAL READING

**Beardsell, D.** 1997. Nursery industry water management best practice guidelines Australia 1997. Nursery Industry Association of Australia.

**Cresswell, C.G. and D.O. Huett.** 1996. Managing nursery runoff. New South Wales Agriculture.

**Mitrovic, S.** 1995. What scum is that? Department of Land and Water, New South Wales, Australia.

**New South Wales Agriculture.** 1995. Waterwork New South Wales, Australia.

**Rolfe C., A. Currey, and I. Atkinson.** 2000. Managing Water in Plant Nurseries. New South Wales Agriculture, New South Wales, Australia.

## Grafting of Waxflowers for Root Rot Management®

Ian Gordon

Program Leader — Capacity Building, Centre for Native Floriculture, School of Agronomy and Horticulture, The University of Queensland Gatton, Gatton QLD 4343 Australia

### INTRODUCTION

The genus *Chamelaucium* is a genus of medium- to tall-growing shrubs endemic to the southern and central regions of Western Australia. *Chamelaucium* has been widely cultivated as an export cut flower crop in various regions of Australia. The locality around the Gatton Campus of the University of Queensland has a number of native flower farms growing waxflowers, and the crops produced here are amongst the earliest to flower in Australia. This gives our local growers a competitive edge over growers in other parts of Australia.

The heavy soils of the Gatton district and the high humidity and summer rainfall create a difficult management problem for soil-borne diseases such as *Phytophthora cinnamomi* and other related fungal organisms. Regular drenches of anti-fungal compounds are part of the management program for waxflower growers. However, despite this management practice, many growers experience heavy losses of newly planted selections of waxflower.

At the University, we started to look at the potential for grafting of waxflowers onto rootstocks that are highly resistant to *P. cinnamomi*. The grafting program was developed at the Gatton Campus of the University of Queensland (UQ) about 10 years ago, and the UQ Gatton Plant Nursery is producing grafted plants for the local flower industry and for sale through the retail nursery industry as flowering pot plants in late winter and spring.

### THE ROOTSTOCKS

University of Queensland Gatton became involved in grafting trials as a result of a request by Ken Young of Ebonybrook waxflower farm. Ken approached me with a request that I look at grafting of waxflower cultivars onto rootstocks that appeared to be resistant to *Phytophthora* root rot at Ebonybrook. These rootstocks are *Chamelaucium* selections, which were able to grow in root-rot-infected conditions at Ebonybrook. We propagated some cuttings of these selections, and when these plants were large enough, I experimented by trying a number of grafting techniques to graft different waxflower cultivars. The most successful graft was a spliced side graft where the top was retained on the rootstock until after the graft union had formed. The initial trials showed a success rate of 92% with the spliced side graft, compared to 54% with a simple whip graft. On the basis of this success we have continued to use the spliced side graft for commercial production of grafted plants.

There are several different waxflower selections that we have used as rootstocks, and in order to maintain a commercial edge in the marketing of grafted waxflowers, we have not revealed the identity of the rootstocks. However, a UQ Gatton PhD student, Greg O'Sullivan, carried out a series of inoculation studies under the supervision of our Plant Pathologist, Dr. Vic Galea, and he was able to demonstrate that these rootstock selections were highly resistant to *P. cinnamomi* inoculation. Field trials of grafted waxflowers planted into root-rot-infected soils have demon-

strated that the loss rate after planting is very low. I have also experimented with the use of *Leptospermum* and *Melaleuca* selections as rootstocks. However, some cultivars of waxflower have shown delayed incompatibility after grafting, and we have discontinued using these as rootstocks.

**The Propagation of the Rootstocks.** Grafting takes place from October to April at UQ Gatton Plant Nursery. We find that grafting during winter does not give satisfactory results with many *Chamaelucium* selections. This is probably a result of the onset of flower bud development. The propagation of rootstocks is from soft-wood terminal stem cuttings. Rootstock propagation takes place during autumn and early winter. The cuttings are trimmed to approximately 5 cm long and dipped in Rootex L liquid hormone (4000 mg·L<sup>-1</sup> IBA).

The propagation trays used are 100-cell trays supplied by Premium Plastics of Perth. The cells are small and are shaped to promote air pruning of the roots as they develop on the base of the cuttings. The propagation environment used is a high-pressure fog-controlled greenhouse with heavy shade and a warm-water heating system on the benches designed to maintain 25 °C at the base of the cuttings.

Root development on the cuttings occurs at the 4–6 week stage, and after 6 weeks, the trays of cuttings are moved to a hardening off area for another 2–3 weeks prior to potting of the cuttings. The rooted cuttings are potted into native tubes (50 × 50 × 100 mm deep tubes). The rooted cuttings are then placed on open-topped benches in a high light greenhouse. The native tubes have internal ribs, which direct roots downwards in the tubes, and the open-topped benches promote air pruning of the roots. The strike rate in propagation can vary according to cutting quality, but with good quality cuttings in our propagation facility, we expect to get 85%–90% strike rate. The rootstocks are ready to graft when the basal stem area is around 2 mm thick. This generally takes 8–10 weeks from tubing up.

## THE GRAFTING PROGRAM

Successful grafting requires operator skill and a sharp knife. Knowledge of knife sharpening is essential to grafting success. Grafting takes place in an air-conditioned workroom for operator comfort and for plant comfort. As mentioned previously, the graft that is used is a spliced side graft. Given that the stems of the rootstocks are very thin, all that is required is a 2–3 cm long slice of bark removed from the side of the rootstock about 5 cm above medium level in the pots, and a corresponding sized slice of bark is removed from the base of the scion stem. The two cut surfaces are very carefully matched together, and the graft is tightly tied using a thin strip of Parafilm tape. Parafilm is preferred because it stretches during the tying operation and it breaks down as a result of UV degradation over time. This means we don't need to remove the tape after grafting.

The grafted plants are placed in a high humidity propagation greenhouse on heated benches, which maintain 25 °C at bench level. Humidity is managed by a high-pressure fogging system so that we can maintain humidity of 85%–90% during the first few weeks after grafting. Two weeks after grafting, the graft union is forming and, with most scion shoots, regrowth is starting to appear. At this time we carefully cut back the top of the rootstock to the graft union, which encourages the scion shoots to produce a bushy top to the grafted plant. Grafted plants remain in the high-humidity greenhouse for 2 weeks after cutting back of the rootstocks.



At this time the grafted plants are moved to a high-light greenhouse to continue growth. The propagation success rate achieved during grafting is very high with most *Chamaelucium* cultivars and is consistently above 95%.

The grafted plants are tip pruned to promote a bushy, multi-stem habit. When the grafted plants are about 3 months old, they are moved out into a full sun growing area for final sun hardening prior to despatch to the customer. The grafted plants are inspected regularly, and any sideshoot growth from below the graft union is removed to prevent rootstock regrowth. Grafted plants are supplied to flower growers in the native tubes for field planting. A number of southeast Queensland waxflower growers are using grafted plants rather than cutting-grown plants because they believe that the improved vigour of the grafted plants and the root-rot inhibition provides larger and more vigorous plants.

**The Benefits of Grafted Plants to the Waxflower Grower.** During 1998, a large trial of grafted plants of 'Purple Pride', 'Winter White', and 'Iceberg' was planted in a waxflower plantation close to UQ Gatton. There are approximately 2,500 grafted plants on four different rootstock selections in this block. As far as we can ascertain, this block of grafted plants is the largest block of grafted Australian native plants established anywhere in Australia.

The benefits of using grafted plants can be summarised as follows:

- Built in resistance to *Phytophthora* root rot.
- Ensures long-term survival of plants in the field.
- Grafted plants are more vigorous and uniform in growth.
- Grafted plants require less fungicide use.
- This represents a reduced cost to the grower.
- There are additional environmental benefits.

**Grafting for the Retail Nursery Industry.** University of Queensland Gatton Plant Nursery is providing grafted plants to Redlands Nursery for growing as flowering pot plants. These grafted plants are marketed to the retail nursery industry under the name "Elite Grafted Wax." A number of different waxflower selections are used in this marketing program, and there is a strong demand for Elite Grafted Wax in the east coast nursery industry. A large grafting program is currently under way for next season's Elite Grafted Wax plants.

**Propagation Licence Agreements.** University of Queensland Gatton has a propagation Licence Agreement in place with Western Flora Nursery of Western Australia. This enables us to propagate and market their PBR-protected cultivars in Queensland and New South Wales. We also have a propagation sub-licence agreement in place with Western Flora that enables us to propagate the new AgWest waxflower selections for sale within Australia. This means that the new "Pearl" series waxflowers are now available in Queensland. There is strong interest in the Queensland waxflower industry in gaining access to these protected cultivars.

**Grafted Waxflower Sales.** During the time that the UQ Gatton Plant Nursery has been producing grafted plants we have produced in excess of 30,000 grafted plants. During the current grafting season we expect to graft 25,000 waxflower plants for the flower industry and for sale through Redlands Nursery as "Elite Grafted Wax." I believe that this grafting program for wildflowers is the most successful program of its kind in Australia.

## Phormiums: Production in 2005<sup>©</sup>

**Robert Bett**

Lyndale Nurseries Auckland Ltd, PO Box 81–022, Whenuapai, Auckland, New Zealand

### INTRODUCTION

Multiplication rates are one of the key factors affecting volume production of *Phormium* cultivars around the world. Tissue culture techniques can now be harnessed to give volume production with certain cultivars in the lab. Significant improvements have been made in this field over the last 4 years in New Zealand. With the plants established and running well in tissue culture, the first obstacle to the commercial growers is acclimatising the material from the lab into the nursery environment. This paper focuses on our experience at Lyndale Nurseries with *Phormium* production in 2005.

### TISSUE CULTURE

**Medium.** With all crops, knowing and understanding your medium is the first essential step. With phormiums, the key is to have an open medium with an air-filled porosity (AFP) of 17%–20%.

We use two media for deflasking phormiums (Fig. 1):

- 1) 9 pumice (3–5 mm) : 1 peat (v/v).
- 2) Compressed sphagnum moss cell — a new product from New Zealand.

Both media are used in a 128 cell trays (cell dimension 25 × 25 × 45 mm), these trays allow for good airflow between plants and allow for minimum root disturbance at the time of transplanting.



**Figure 1.** Media: Left to right (top row): pumice (3–5mm), peat, 90% pumice : 10% peat, (bottom row) compressed sphagnum, and expanded sphagnum.



**Figure 2.** *Phormium* 'Merlot' 6-month-old plugs ready for transplanting.

**Deflasking.** Plants arrive from the lab in flasks of 30 plants. The plants are graded on arrival by height and set straight from the flasks into 128-cell trays. Best results are achieved when plants are between 40–50 mm in height at the time of deflasking.

Care is taken throughout the deflasking stage to maintain a clean hygienic environment.

Plants are transported from the deflasking room to the production house by a covered trolley to prevent desiccation of the young leaves. With all micropropagated crops no waxy cuticle is present on the leaf for the first 2–4 days following deflasking.

Plants are deflasked using natural season in New Zealand September–March (spring– autumn) under mist with a calorie counter with a bottom heat 21 °C and air temperature ranging 20–25 °C.

The young plants are ready for transplanting 4–6 months from initial deflasking—this is dependant on the cultivar being grown (Fig. 2).

**Advances in Tissue Culture of Variegated Forms.** Talk often comes round to the future possibilities of tissue culture of the often-flamboyant variegated selections. To date tissue culture activities on these selections has been unsuccessful.

*Phormium* 'Red Dragon' is a new vigorous red variegated sport that was initiated into tissue culture in 2003 (Fig. 3). This cultivar has strong red variegated leaf margins and a dark central area to the leaf.

Figure 4 shows the range of variegation expressed in the resulting plants following tissue culture production of the 'Red Dragon' cultivar (Fig. 4). Ninety-five percent of the resulting plants have lost all red colouration. Five percent of the



Figure 3. *Phormium* 'Red Dragon'.

resulting plants expressed some degree of colouration. Less than 1% shows the original characteristics of the variety.

**Future Possibilities.** The key to successful *in vitro* propagation of *Phormium* at present is the selection of cultivars with solid foliage colours and unique foliage forms.

## CULTIVAR REVIEW

### Currently Produced in Tissue Culture.

***Phormium* 'Black Rage'.** 'Black Rage' is a fashionable slate-grey-foliaged plant. It is an architectural upright growing cultivar drooping at the tips and a beautiful blue bloom on the flower stem and underside of the foliage. Strong orange-coloured flowers (flower spike 1.2 m). A key feature of this selection is the promiscuous flowering and attractive spiralling seedpods. A great cultivar for mass planting; size is 0.8 × 0.8 m.

***Phormium* 'Merlot'.** 'Merlot' is an excellent architectural foliage plant (Fig. 5). Strong upright broad leaves, deep plum-purple in colour. Leaf underside is silver with leaf edges and midrib highlight in jet black. An excellent feature plant; hardy; 1.8 × 1.8 m; flower spike 2.4 m.

***Phormium* 'Twisted Sister'.** 'Twisted Sister' is a sport of *P. tenax*. The foliage and plant form of this selection is a whole new break for the genus. This funky little



**Figure 4.** Range of variegation expressed in the resulting tissue culture plants derived from *Phormium* 'Red Dragon'.



**Figure 5.** *Phormium* 'Merlot'.



**Figure 6.** *Phormium* 'Twisted Sister'.

plant has extremely stiff olive green, twisted, and spiralling foliage, as if heated like hot molten metal, and then let cool. The foliage has an attractive grey-silver underside and bright orange leaf margins and midrib to complete the picture. All this makes 'Twisted Sister' the perfect architectural foliage plant for modern terrace and patio plantings; hardy; 0.4 × 0.4 m (Fig. 6).

#### **Cultivars for Future Multiplication in Tissue Culture.**

***Phormium* 'Garden Hero'**. One of the smallest selections, this new selection has very fine lime green foliage and a tight clump-forming habit. 'Garden Hero' is ideal for pots and plants on the deck or patio or for mass planting at the front of the garden border, hardy, 0.6 × 0.6 m.

***Phormium* 'Goliath'**. 'Goliath' is the largest selection from New Zealand, with huge upright architectural foliage drooping at the tips. The foliage is 250–300 mm in diameter, silver green in colour with beautiful silver-blue on the underside of the foliage. A great landscape cultivar of the future, for mass planting, 3 × 2 m, flower spike 3.5 m.



## Growing Australian and South African Native Plants in Soilless Media<sup>®</sup>

**Kevin Handreck**

Managing Director, Netherwood Horticultural Consultants Pty Ltd, 2 Birdwood St, Netherby, South Australia, 5062

**Much of the Australian and South African flora have evolved on soils of low fertility. Those of heathland soils have had to evolve mechanisms for growing in soils with extremely low levels of total and "plant-available" phosphorus. Application of phosphatic fertiliser to these heathland soils eventually leads to the death of these species and the invasion of weeds. From the late 1970s, it has been known that heathland species being grown in soilless potting media must be provided with only very low amounts of phosphorus. This knowledge has often been extended without question to include our entire diverse flora. However, many of our flora are not particularly sensitive to phosphorus. For good growth, they require as much phosphorus as most northern hemisphere plants. This paper explores the different requirements for phosphorus of different groups of species within our flora. It offers practical guidelines for the successful propagation and growing of these diverse groups of species in soilless media.**

### INTRODUCTION

The flora of Australia and South Africa are wonderful to see in their native habitats, especially when they are in flower, but they are also wonderful to see in our gardens, city landscapes, and patio containers. Transfer from the bush, fynbos, and veldt to urban environments requires the production of seedlings or vegetatively propagated plants in containers, and those containers must be filled with a growing medium. At least in Australia, early efforts at container-growing used natural soils or such soils that had been amended with manures and composts. This was essentially the system devised in England at the John Innes Institute. Success rates were sometimes good, but often poor. These soils were typically amended with  $1.5 \text{ kg m}^{-3}$  of single superphosphate. Success rates became worse as soil was replaced by peat (as in the University of California method) and composted wood wastes such as pine bark and sawdust. Nichols et al. (1979) showed that the particularly poor success rates with members of the Proteaceae family (especially grevilleas and proteas) were due to toxicity produced by excessive supply of phosphorus (P) (still from the same addition of single superphosphate). Nichols and Beardsell (1981) provided guidelines for the rates of P from controlled-release fertiliser (CRF) to be used so that P toxicity was avoided when various Proteaceae were grown in soilless media.

As the guidelines produced for P-sensitive Proteaceae were applied in production nurseries, a myth developed in Australia that **all** Australian native plants were sensitive to P. So we had marketed (and to a small extent still do) low-P fertilisers that were labelled as being suitable for all Australian native plants and South African Proteaceae. This inevitably led to the situation in which many Australian native plants, even some Proteaceae, did not grow well in containers of soilless media. They were suffering from P deficiency. The myth was extended also to proteas



being grown in soil for cut flowers. If P was left out of the fertiliser applied to these often-depauperate soils, growth was poor. I have seen strange recommendations for overcoming P toxicity in such plants, even though tissue analysis indicated the extremely low P concentrations of P deficiency.

The point I want to make is that while some Australian and South African species are highly prone to P toxicity, and some are moderately sensitive, the majority are not. This majority do not need the level of P input that might be provided to tomatoes, but they do need more than the tiny amounts tolerated by sensitive species. They have evolved on soils that might have 100 to 300 mg·kg<sup>-1</sup> of total P (Norrish and Rosser, 1983). In contrast, the soils on which P-sensitive plants evolved often contain less than 20 mg·kg<sup>-1</sup> total P and as little as 1 mg·kg<sup>-1</sup> (Bell et al., 1994). Nursery practice must reflect this diversity of origins. The rest of this paper provides guidelines for producing our native plants in soilless media without the hassles of either P toxicity or P deficiency. Because much of the research that provided these guidelines was done in Australia on Australian plants, most of my examples are for the Australian flora.

### KNOW YOUR PLANTS

If you do not know the P sensitivity of a new species you want to grow, a first clue is to know its family. If it is classified into Proteaceae or one of the pea-flower families, there is a reasonable probability that it is sensitive to very sensitive. Gymnosperms, succulents, halophytes, annuals, and most Myrtaceae, Casuarinaceae, Cupressaceae, Asteraceae, and rain forest species (including Proteaceae that grow in rain forests) are not sensitive. Acacias are difficult: they range from extremely sensitive to highly tolerant of P. Just to complicate matters, within some species, there can be a range of tolerance to P depending presumably on the properties of the soil on which a particular provenance evolved. A listing of over 800 Australian species is contained in Handreck and Black (1994).

A second clue comes from knowledge of the native habitat of the particular species. If the soils of this habitat are highly acidic, and/or deep, light-coloured sand, and/or of low organic matter content, and/or formed from ancient metamorphic rocks, particularly sandstones such as those of the Sydney region, there is a high probability that many of the Proteaceae, pea-flowers, and acacias growing there will be sensitive to P. Calcareous soils and those derived from volcanic rocks, including granite, tend to have few P-sensitive species (Handreck, 1997a).

A third clue, rarely available, is the total P content of the topsoil of the area from which the species, or the parents of a cultivar, came. The lower this is in the range 1 to 100 mg·kg<sup>-1</sup>, the greater the probability that species growing in the soil are sensitive to P.

### IRON SUPPLY

It was early recognised that the growing medium for P-sensitive plants needed to be quite acidic (Higgs, 1970). Low pH minimises the availability of the P in the medium, but it also maximises the availability of iron. The environment around plant roots must be of pH 5.6 or lower if the plant is to get enough iron for optimum growth and colour. Either the soil itself must be this acidic or the plant must have an ability to secrete acid from its roots. As the roots of many of the plants that evolved on acidic soils do not secrete acid (they did not have to waste energy

**Table 1.** Guidelines for supplying P to plants growing in soilless potting media. (Based on Handreck, 1997a, b).

Category of P-sensitivity	P concentration in 0.2 mM DTPA extract (mg·L <sup>-1</sup> )	Typical basal P application rate	Pws concentration in controlled-release fertiliser incorporated at 3g·L <sup>-1</sup> (%)*	Approximate weekly need for P by young seedlings (mg)	Approximate weekly needs for P of plants approaching saleable size
Non-sensitive	3-8	0.3 kg·m <sup>-3</sup> single superphosphate	2.2+	0.3 to 0.6	4
Moderately sensitive	<3	Nil	1.3	0.3	0.5
Highly sensitive	<1	Nil	0.4	0.2	0.3

Pws= Water-soluble P in fertiliser.

\*Data for 5-month-release fertilisers in containers up to 0.4 L capacity. Data assume some losses of P through leaching and immobilisation by microbial activity. Use lower rates and/or P concentrations for larger containers.

on doing this) the pH of potting media for them must be no higher than 5.6. But low pH is of no use unless there is enough iron in the medium to be dissolved. In Australia, most of our potting media consist largely of composted pine bark (from *Pinus radiata* in the south and *P. elliottii* and *P. pinaster* selections in the subtropics). These barks typically contain less than 100 mg·kg<sup>-1</sup> total iron, so extra must be added to them when they are formulated into potting media. For general nursery production, about 1 kg·m<sup>-3</sup> of FeSO<sub>4</sub>·7H<sub>2</sub>O (or 0.6 kg·m<sup>-3</sup> of the monohydrate) is added, but for P-sensitive species up to double this rate can be used. In contrast, in South Africa, most pine barks have much higher natural levels of iron and extra iron is generally not needed. Rather than simply relying on a recipe-book approach to formulation, the level of plant-available iron should be determined chemically. A 0.2 mM DTPA extract (1 : 1.5, v/v) of the medium should contain at least 25 mg·L<sup>-1</sup> of Fe for all plants (native and otherwise) and 35 mg·L<sup>-1</sup> for P-sensitive plants (Handreck and Black, 1994; Standards Australia, 2003). It should be noted that these analytical criteria do not apply if the main source of iron is a synthetic chelate.

## PHOSPHORUS SUPPLY

If you try to grow *Melaleuca* or *Eucalyptus* species from seed without any P in the potting medium, you will find that as soon as the P in the seed is used up the seedlings stop growing; the smaller the seed, the sooner the growth cessation. In potting media, non-P-sensitive species must be supplied with soluble P from the time of germination. In contrast, for highly P-sensitive plants the level of soluble P in the medium must be very low. Table 1 gives guidelines.

Also provided in the table are some guidelines for the rates of supply of P

from fertilisers, both controlled-release and fertigated. The important number is not the concentration of P in the fertiliser, but the **amount** provided each week to the plant. Of course the amount needed will increase as the plant grows. Differing amounts are easier to provide via fertigation than via CRFs incorporated into the medium, but as CRFs release their P more slowly than their N and K (Handreck, 1997c), there is some tolerance to a CRF addition that is slanted towards provision for later growth. It is especially important to reduce the rate of CRF incorporation ( $\text{g}\cdot\text{L}^{-1}$ ) as container size increases, so that the amount of P (and N) supplied still matches plant requirements.

If you do not know the tolerance of a particular plant to P, and you do not have time to run a trial, the safest approach is to use a potting medium and fertiliser designed for highly P-sensitive plants and then add extra P if deficiency symptoms appear.

### OTHER PRACTICALITIES

Growers can increase their chances of success if they tightly specify key properties of their potting medium. The pH must be below 6.5 for all plants and below 5.5 for highly-P-sensitive plants. The initial P concentration must be as given in Table 1 and the extractable iron concentration must be as high as is required (above). Of course all other nutrients must also be supplied.

Checking the pH and water-soluble P concentration of potting medium at delivery can prevent large-scale disasters. Several kits are available from chemical supply houses for testing for water-soluble P. One is the Merck Aquaquant P (VM) kit (Handreck and Anderson, 1994). All you do is shake 1 volume of the moist medium with 1.5 volumes of water, filter, and measure the P concentration in the filtrate. Any medium that is not up to specifications ( $<1 \text{ mg}\cdot\text{L}^{-1}$  P for P-sensitive plants) must be rejected.

Products such as blood and bone, crushed bone, animal manures, and biosolids should be used with caution in potting media for P-sensitive plants. All contain P sources that continue to release soluble P for many months. The lower the pH of the medium, the more rapid the release. For bone, an upper limit for P-sensitive plants is about  $0.4 \text{ g}\cdot\text{L}^{-1}$  and for biosolids (of 1.6% P) about 0.2% (v/v). As little as 0.5% of such biosolids can supply all the P requirements of nonsensitive plants (Handreck, 1997a).

### LITERATURE CITED

- Bell, T.L., J.S. Pate, and K.W. Dixon. 1994. Response of mycorrhizal seedlings of SW Australian sandplain Epacridaceae to added nitrogen and phosphorus. *J. Exp. Bot.* 45:779–790.
- Handreck, K.A. 1997a. Phosphorus requirements of Australian native plants. *Aust. J. Soil Res.*, 35:241–289.
- Handreck, K.A. 1997b. How much soluble phosphorus is needed by phosphorus-sensitive plants? *Aust. Hortic.*, May: 75–77.
- Handreck, K.A. 1997c. Controlled-release fertilisers: Measuring nutrient release rates. *Austral. Hort.* October: 51–53.
- Handreck, K.A. and J. Anderson. 1994. No more phosphorus toxicity. *Austral. Hort.* November: 38–40.
- Handreck, K.A. and N.D. Black. 1994. Growing media for ornamental plants and turf, 3rd Ed. UNSW Press, Sydney.
- Higgs, A.L. 1970. The effect of planting depth and fertilizer on survival and growth of *Grevillea* and *Leptospermum* rooted cuttings. *Austral. Plants* 6:23–25.
- Nichols, D.G., D.L. Jones, and D.V. Beardsell. 1979. The effect of phosphorus on the growth of *Grevillea* 'Poorinda Firebird' in soil-less potting mixtures. *Scientia Hort.* 11:197–205.

- Nichols, D.G. and D.V. Beardsell. 1981. The response of phosphorus-sensitive plants to slow-release fertilizers in soil-less potting mixtures. *Scientia Hort.* 15:301–309.
- Norrish, K. and H. Rosser. 1983. Mineral phosphate, pp. 335–364. In: *Soils: An Australian viewpoint*. Division of Soils, CSIRO. CSIRO: Melbourne/Academic Press, London.
- Standards Australia. 2003. Australian standard for potting mixes. Standards Australia, Sydney.

## Breeding and Selection of *Brachychiton*®

### Des Boorman

132a Nothcott Rd., South Gundurimba via Lismore, NSW, Australia

### INTRODUCTION

#### Why *Brachychiton*?

- Beautiful trees naturally
- Ornamental trunks and foliage
- Free flowering
- Colours, white, red, pink, orange, and greenish
- Flowers up to 50 mm long and 40 mm wide in some species
- Many are deciduous flowering plants
- Flowering period can be many months
- Drought tolerant
- Not likely to become weeds

These make ideal characteristics for breeding.

### BREEDING

**Some Drawbacks.** Some species may have flowers that upon falling could be a slip hazard to pedestrians and motorcycles. *Brachychiton discolor* F. Muell is such a species that produces mucilaginous excretions from fallen flowers. This results in an extremely slippery surface when it falls onto hard paved areas.

Substantial juvenility periods may hinder breeding and assessment programs.

**Background.** This genus contains many familiar species that are important ornamental and agricultural trees. *Brachychiton populneus* (Schott and Endl.) R.Br. kurrajong is considered an important fodder species during droughts, providing valuable feed for livestock, and has been planted for this purpose.

The other, more popular species are ornamental trees such as the Illawarra flame tree *B. acerifolius* (Cunn. Ex Endl.) Macarthur, Queensland lace-bark *B. discolor* F. Muell., and the Queensland bottle tree *B. rupestris* (Mitchell ex Lindley) Schumann. The latter has a spectacular bottle-shaped trunk that can grow to several metres in diameter (Guymer, 1988).

**Assessment of Hybrids.** The hybrids will be assessed on their:

- Precociousness, flower colour, size, and inflorescence size; flowering period, annual flowering, and duration of flowering season.
- Foliage colour and shape and the colour of the new growth.
- Tolerance to drought, frosts, and wet conditions.
- Mature size when compared to the three parameters for selection, specimen trees, trees under powerlines, and tub specimens.

- Nichols, D.G. and D.V. Beardsell. 1981. The response of phosphorus-sensitive plants to slow-release fertilizers in soil-less potting mixtures. *Scientia Hort.* 15:301–309.
- Norrish, K. and H. Rosser. 1983. Mineral phosphate, pp. 335–364. In: *Soils: An Australian viewpoint*. Division of Soils, CSIRO. CSIRO: Melbourne/Academic Press, London.
- Standards Australia. 2003. Australian standard for potting mixes. Standards Australia, Sydney.

## Breeding and Selection of *Brachychiton*®

**Des Boorman**

132a Nothcott Rd., South Gundurimba via Lismore, NSW, Australia

### INTRODUCTION

#### Why *Brachychiton*?

- Beautiful trees naturally
- Ornamental trunks and foliage
- Free flowering
- Colours, white, red, pink, orange, and greenish
- Flowers up to 50 mm long and 40 mm wide in some species
- Many are deciduous flowering plants
- Flowering period can be many months
- Drought tolerant
- Not likely to become weeds

These make ideal characteristics for breeding.

### BREEDING

**Some Drawbacks.** Some species may have flowers that upon falling could be a slip hazard to pedestrians and motorcycles. *Brachychiton discolor* F. Muell is such a species that produces mucilaginous excretions from fallen flowers. This results in an extremely slippery surface when it falls onto hard paved areas.

Substantial juvenility periods may hinder breeding and assessment programs.

**Background.** This genus contains many familiar species that are important ornamental and agricultural trees. *Brachychiton populneus* (Schott and Endl.) R.Br. kurrajong is considered an important fodder species during droughts, providing valuable feed for livestock, and has been planted for this purpose.

The other, more popular species are ornamental trees such as the Illawarra flame tree *B. acerifolius* (Cunn. Ex Endl.) Macarthur, Queensland lace-bark *B. discolor* F. Muell., and the Queensland bottle tree *B. rupestris* (Mitchell ex Lindley) Schumann. The latter has a spectacular bottle-shaped trunk that can grow to several metres in diameter (Guymer, 1988).

**Assessment of Hybrids.** The hybrids will be assessed on their:

- Precociousness, flower colour, size, and inflorescence size; flowering period, annual flowering, and duration of flowering season.
- Foliage colour and shape and the colour of the new growth.
- Tolerance to drought, frosts, and wet conditions.
- Mature size when compared to the three parameters for selection, specimen trees, trees under powerlines, and tub specimens.

**BREEDING.**

- Flowers are functionally unisexual by abortion, Schott and Endlicher (1832).
- Flowers generally are open for 2 days, falling on the 3rd.
- Flowers usually occur on the lower branches first closer to the trunk. Male flowers are much more numerous than female flowers, which often open later in the flowering period.
- Native bees are extremely fond of the pollen. Flowering in the tropics starts in September and continues through to November for *B. bidwillii* Hook.
  - This species (*B. bidwillii* Hook) is extremely useful as a parent because it is precocious and free flowering, producing large quantities of pollen and also a proportional number of female flowers.
  - The species is ideal because it has a low growth habit, freely branches, and is tolerant of a range of climatic extremes from tropical summers to frosty inland areas where it naturally occurs.
- Many of the earlier trial pollinations were unsuccessful because flowers are receptive to pollen on both days but abscission has already commenced on the second day, so fertilization is not successful and flowers are aborted.
- Pollination is also sensitive to the time of day with pollination activities after 8:30 AM on the first day not being successful. This is also exacerbated by hot dry winds or overly hot mornings.
- Fertilisation results in a rather swift swelling of the ovaries that is clearly visible after several days.
- Flower abortion can occur after a week or so and may be a result of nutrient or moisture stress on the parent.
- Boring larvae can also cause abortion of nearly mature pods even if only 2–3 of the 20 or so seeds have been damaged.

**Parent Selection.** Scion and rootstock interactions can also stunt growth and promote flowering such as between *B. acerifolius* (Cunn. Ex Endl.) Macarthur rootstocks and *B. garrawayae* (Bailey) Guymer scions. Scion growth is stunted causing it to produce relatively large numbers of flowers for the plant size. *Brachychiton garrawayae* (Bailey) Guymer is noted as growing to 12 m, but I have not grown a grafted specimen over 0.75 m. They have on two occasions produced so many flowers and subsequent fruit when deciduous that the plants have died. I do not believe that it is incompatibility but rather a hypersensitivity to some latent pathogen in the rootstock (Boorman, 2003).

The five species that I have used to date for breeding are *B. Bidwillii* Hook, *B. garrawayae* (Bailey) Guymer, *B. grandiflorus* Guymer, *B. velutinosus* Kostermans, *B. sp.* Exmore Station, and the natural hybrid *B. xcarneus* Guymer, (*B. garrawayae* × *B. grandiflorus*).

Other species that I have and am waiting for first flowering are *B. albidus* Guymer, *B. chillagoensis* Guymer, *B. discolor* F. Muell., *B. xvicolor* Guymer (*B. acerifolius* × *B. populneus* subsp. *populneus*), *B. acerifolius* × *B. discolor*, and three unnamed hybrids or species.

I will also include *B. acerifolius* (Cunn. Ex G. Don) Macarthur and *B. rupestris* (Mitchell ex Lindley) Schumann. Both species appear to have extremely long juvenile phases that make breeding programs time-consuming, so precocious species are the first I have used while establishing the other stock plants.

*Brachychiton* × *carneus* Guymer (*B. garrawayae* × *B. grandiflorus*) has produced some interesting responses to insect attack, possibly a fruit-piercing moth. This response was a particularly strong terminal panicle that flowered over 3 months from both tips affected.

This may indicate the possibility of using growth regulators to promote flowering for breeding and display purposes.

The breeding has resulted in the production of 100 of *B. bidwillii* × *B. grandiflorus* and 120 *B. bidwillii* × *B. carneus*, which are 2 years old and planted out in test blocks at 3 m spacing for assessment.

The next batch consists of *B. garrawayae* × *B. bidwillii*, *B. grandiflorus* × *B. velutinosus*, *B. garrawayae* × *B. sp.* Exmore Station, and *B. bidwillii* × *B. sp.* Exmore Station and consists of 300 plants that will be planted in the trial block in spring.

#### LITERATURE CITED

- Elliot, W.R. and D.L. Jones. 1985. Encyclopaedia of Australian plants Vol. 2. Lothian Pub. Co. Pty. Ltd., Melbourne.
- Guymer, G.P. 1988. A taxonomic revision of *Brachychiton* (Sterculiaceae). Austral. Syst. Bot. 1:259
- Schott, H.W. and S.L. Endlicher. 1832. Melet. Bot. 17 1832.



## New Plants From New Zealand®

### Malcolm Woolmore

Lyndale Nurseries Auckland Ltd, PO Box 81-022, Whenuapai, Auckland, New Zealand

### INTRODUCTION

Lyndale specialises in the propagation of a wide range of ornamental plants with strong associations to the breeding, sourcing, and protection of new cultivars.

With a population of just 4 million, New Zealand businesses have evolved to look at the world market as the natural area to expand into, as the domestic market is small. Lyndale is no different and, with a production that hovers around the 3 million units mark, needed to explore other market possibilities if the business was to continue to grow.

The business of exporting live plants between countries is by no means easy, and it is getting bureaucratically more difficult seemingly daily. Lyndale's approach to this problem has been to develop the intellectual property of plant cultivars and offer new selections through an international network of agents. Each international market block has the right (predominantly) to self-propagate, distribute, and commercialise within their own defined market boundaries; hence Lyndale's involvement in shipping live plants is minimal.

The crops reviewed in this paper are some of the selections we find most exciting and have been bred or selected in New Zealand.

### NEW CROPS

***Coprosma propinqua* 'Autumn Haze'**. This colourful new prostrate coprosma from the Chatham Islands was selected by Tom Johnson at Totara Grove. 'Autumn Haze' has small glossy cream and green variegated foliage delightfully coloured with soft peach to apricot tones. The plant forms a dense groundcover, making it an ideal choice for low maintenance gardening at the front of the border or as a specimen in a low pot on the deck or patio. 'Autumn Haze' is happy in fertile, well-drained soils in full sun to part shade. Lightly trim to maintain shape. Hardy. 0.2 × 1.5 m.

***Corokia ×virgata* 'Geenty's Ghost'**. 'Geenty's Ghost' is a delightful silver/grey foliage selection of *Corokia* bred by New Zealand plantsman Mike Geenty. This new selection forms an attractive medium-sized ornamental shrub ideally suited for use as a small hedge or for topiary work in today's smaller gardens. 'Geenty's Ghost's' small, silver-decorative foliage is complemented in autumn with colourful yellow-orange berries. Happy in fertile, well-drained soils in full sun to part shade and tolerant of extremely dry and salt winds, it is a popular choice for coastal shelter planting. Trim to maintain a good bushy shape. Hardy. 1.2 × 1 m.

***Griselinia littoralis* 'Whenuapai'**. This exciting new selection made by Tom Johnson at Totara Grove has small glossy leaves and forms a tight narrow column, making it an ideal choice for modern architectural plantings. The narrow glossy foliage has a distinctive pointed leaf tip, which makes for a tidy appearance. 'Whenuapai' is ideally suited for hedging, topiary work, and coastal plantings. Happy in fertile, well-drained soils in full sun to part shade. Lightly trim to maintain shape. Hardy. 8 × 4 m.

***Libertia ixiodes* 'Goldfinger'**. Looking for fantastic golden yellow cascading foliage in the garden? This is the plant for you. The elegant weeping foliage of this exciting new selection has a prominent golden-yellow central stripe. Profusions of pure white star-like flowers are produced in clusters just clear of the foliage from mid spring, followed by attractive large yellow berries in autumn. This delightful little plant really packs a punch and is ideal to provide year round interest in the perennial border or as a colourful low maintenance pot or container on the deck or patio. Hardy.  $0.6 \times 0.6$  m.

***Libertia ixiodes* 'Taupo Blaze'**. 'Taupo Blaze' is a superior selection of 'Taupo Sunset' produced exclusively from tissue culture. In autumn/winter the spiky sword-like foliage of 'Taupo Blaze' changes from green through yellow/orange to strong orange to intense burnt red. 'Taupo Blaze' has much more pronounced scarlet foliage colour than the original selection. To complement the colourful foliage, pure white star-like flowers are produced in spring in clusters just clear of the foliage, followed by attractive orange/red berries in autumn. This colourful little plant is ideal to provide year-round interest in the perennial border or as a colourful low maintenance pot or container plant on the deck or patio. Hardy.  $0.6 \times 0.6$  m.

***Metrosideros collina* 'Tahitian Sunset'**. A colourful dwarf-growing sport of *M. collina* 'Tahiti' has elegant cream-variegated foliage; the new growth is soft like deer velvet and highlighted in winter by bold pink-red flush on the new growth. To complement the foliage, brilliant scarlet bottle-bush-like blooms are produced intermittently throughout the year from clusters of dusty white buds; these colourful blooms are most welcome in the winter months. Quite distinct from the more familiar *M. excelsa* by its compact size and well-rounded, shrubby form. Hardy in coastal locations and as frost tolerant as other New Zealand pohutukawa. Great landscaping versatility, excellent in containers. Attractive in all seasons. Protect from heavy frosts.  $1 \times 1$  m.

***Phormium tenax* 'Twisted Sister'**. 'Twisted Sister' is a sport of *P. tenax*. The foliage and plant form of this selection is a whole new break for the genus. This funky little plant has extremely stiff olive-green, twisted and spiralling foliage, as if heated like hot molten metal and then let cool. The foliage has an attractive grey-silver underside and bright orange leaf margins and mid rib to complete the picture. All this makes 'Twisted Sister' the perfect architectural foliage plant for modern terrace and patio plantings. Hardy.  $0.4 \times 0.4$  m.

***Pittosporum tenuifolium* 'Elfin'**. Looking for a compact, no-trim topiary? 'Elfin' could be just the plant for you! 'Elfin' is an exciting new dwarf *Pittosporum* selection from Clareville Nursery, New Zealand, selected from a batch of *P. tenuifolium* seedlings in 2001 for its amazing tight habit. The mid-green foliage of this selection is much tighter than 'Gold Ball' with the individual internodes being not more than 5 mm apart. To complement the dwarf habit, the plant is quick growing making it the ideal nurseryman's crop. 'Elfin' is the ideal choice where space is limited, perfect for specimen pots or containers in the modern courtyard, or ideal to define the edge of the formal border. Easy in any well-drained soil in full sun to light shade. A fantastic new low-maintenance selection. Hardy to  $-7^{\circ}\text{C}$ .  $0.5 \times 0.5$  m.

***Trachystemon orientalis* 'Gold Medal'**. A colourful sport of *T. orientalis*, the foliage is its main attraction, with large, bright golden yellow leaves that make this

plant a world first. 'Gold Medal' is sure to illuminate any shady border. It is an ideal specimen plant for the shade garden or perfect for a shady container on the deck or patio. Prefers moist woodland soils in light shade. Hardy. 0.5 × 0.5 m.

Thank you for the opportunity to present this paper and congratulations on achieving this milestone for IPPS in South African and for us all.

---

## An Insight into an Accredited Potting Mix Supplier in Australia®

**Shaun Windrim**

Debco Pty. Ltd., 12 Mckirdys Road, Tyabb, Victoria 3913, Australia

### INTRODUCTION

Debco (<[www.debco.com.au](http://www.debco.com.au)>) is a leading potting mix supplier on the east coast of Australia, with manufacturing sites in both New South Wales and Victoria. The company started out selling cow and poultry manures in 1972, but soon evolved over those earlier years to manufacture potting mix primarily from graded, composted *Pinus radiata* pinebark. Other, lesser components included in the matrix depending upon the plant type are coir/coconut fibre and clean quartz sand. This gave potting manufacturing a sophisticated edge as it transformed itself from an art and product made in situ to a science by introducing physical and chemical requirements according to an Australian Standard for potting mixes AS 3743–1996.

### COMPOSTING PROCESS

Raw bark of all shapes and sizes is supplied under contract from several Victorian mills and is then hammer milled and screened into three grades: namely, fine grade (0–3 mm), medium grade (3–5 mm), and a coarse grade (5–8 mm). The raw bark is treated with composting fertilizer (nitrogen, lime, and iron) and trace elements to improve the chelating benefit when taken up by the plants. After this process, the graded nutrient-enriched bark is put into windrows on a concrete pad for composting with a water injection and aerating machine. The composting process can take up to 45 days depending on the season and the grade of the bark. After 3 days, the windrow reaches a temperature of 65 °C, which is the pasteurization process of the bark. This constant temperature eliminates weed seeds and harmful pathogens such as pythium, phytophthora, and rhizoctonia. Over this 45-day period, the aerating machine creates a flue effect, rotating the bark from the bottom to the top and expelling the hot air in the process. During this period, the composting bark temperature, pH, electrical conductivity, nitrogen levels, and nitrogen drawdown index are monitored to establish the maturation stage of the process of the bark for release prior to being blended into a potting mix. A finished composted bark grade normally has a pH of 5 and a nitrogen drawdown index of 0.45–0.5.

Fine-grade coir is brought in from South East Asia in dehydrated compressed bricks. This product receives a quarantine clearance by the Australian Quarantine Inspection Service (AQIS) before receiving an in-house assessment for elevated chloride levels and salt conductivity. A chunky coir chip is also available that allows for a higher air-filled porosity (AFP) than the finer grade. The coir is rehydrated and expanded, providing an instant component to be added to the bark grade as a matrix component.

plant a world first. 'Gold Medal' is sure to illuminate any shady border. It is an ideal specimen plant for the shade garden or perfect for a shady container on the deck or patio. Prefers moist woodland soils in light shade. Hardy. 0.5 × 0.5 m.

Thank you for the opportunity to present this paper and congratulations on achieving this milestone for IPPS in South African and for us all.

---

## An Insight into an Accredited Potting Mix Supplier in Australia®

**Shaun Windrim**

Debco Pty. Ltd., 12 Mckirdys Road, Tyabb, Victoria 3913, Australia

### INTRODUCTION

Debco (<[www.debco.com.au](http://www.debco.com.au)>) is a leading potting mix supplier on the east coast of Australia, with manufacturing sites in both New South Wales and Victoria. The company started out selling cow and poultry manures in 1972, but soon evolved over those earlier years to manufacture potting mix primarily from graded, composted *Pinus radiata* pinebark. Other, lesser components included in the matrix depending upon the plant type are coir/coconut fibre and clean quartz sand. This gave potting manufacturing a sophisticated edge as it transformed itself from an art and product made in situ to a science by introducing physical and chemical requirements according to an Australian Standard for potting mixes AS 3743–1996.

### COMPOSTING PROCESS

Raw bark of all shapes and sizes is supplied under contract from several Victorian mills and is then hammer milled and screened into three grades: namely, fine grade (0–3 mm), medium grade (3–5 mm), and a coarse grade (5–8 mm). The raw bark is treated with composting fertilizer (nitrogen, lime, and iron) and trace elements to improve the chelating benefit when taken up by the plants. After this process, the graded nutrient-enriched bark is put into windrows on a concrete pad for composting with a water injection and aerating machine. The composting process can take up to 45 days depending on the season and the grade of the bark. After 3 days, the windrow reaches a temperature of 65 °C, which is the pasteurization process of the bark. This constant temperature eliminates weed seeds and harmful pathogens such as pythium, phytophthora, and rhizoctonia. Over this 45-day period, the aerating machine creates a flue effect, rotating the bark from the bottom to the top and expelling the hot air in the process. During this period, the composting bark temperature, pH, electrical conductivity, nitrogen levels, and nitrogen drawdown index are monitored to establish the maturation stage of the process of the bark for release prior to being blended into a potting mix. A finished composted bark grade normally has a pH of 5 and a nitrogen drawdown index of 0.45–0.5.

Fine-grade coir is brought in from South East Asia in dehydrated compressed bricks. This product receives a quarantine clearance by the Australian Quarantine Inspection Service (AQIS) before receiving an in-house assessment for elevated chloride levels and salt conductivity. A chunky coir chip is also available that allows for a higher air-filled porosity (AFP) than the finer grade. The coir is rehydrated and expanded, providing an instant component to be added to the bark grade as a matrix component.

## BLENDING PROCESS

Depending on the potting mix and its specific AFP and water-holding capacity requirements, the composted grades are then reintegrated with the coir and sand to prepare a cubic metre matrix. The fine grade pine bark and coir are required for water holding, the medium and coarse grades for structure and AFP, and the sand for ballast and wettability. Debco prepares all matrixes in 2 m<sup>3</sup> batches to ensure appropriate blending consistency. For an example, an annual plant matrix will be sandless and contain three grades of bark and coir, a punnet matrix may only contain two grades of bark and coir, while a shrub mix may contain three grades of bark and sand. Sand has become less popular as an inclusion, due to grade quality, weight factor, and disease potential.

Once the matrix has been decided, a base and pH balancing fertilizer is included which once again is dependent upon a grower's plant product (i.e., lavenders — high pH, 6.0–6.5, indigenous proteaceae plants — low pH, 5.0–5.3, without phosphorus or annuals requiring a middle range pH of 5.3–6.5). Debco provides a total plant matrix package if requested which includes a wetting agent made and sold by Debco (Saturaid), water storage granules, and our home brand controlled release fertilizer (CRF), Green Jacket.

Another requirement we as a supplier must take into consideration is the grower's production systems (i.e., capillary watering, container type, irrigation application, water type, or elastic transplanting machinery matrixes).

## PRICING

Commercial potting mixes are priced in a range from \$75–\$95 per m<sup>3</sup> excluding GST and delivery charges. This means a grower buying an annual potting mix for \$95 per m<sup>3</sup> and potting into a 500-ml container will pay 4.5¢ per container. For example, a grower buying a shrub potting mix for \$75 per m<sup>3</sup> and potting into a 1000-ml container will pay 7.5¢ per container. It is important to assess the cost-benefit ratio of quality, performance, and price per container rather than buying strictly on price per m<sup>3</sup> because a poor quality potting mix can cost you more in production and market time.

## ACCREDITATION

As mentioned in my title, Debco is an accredited potting mix supplier under the Nursery Industry Accreditation Scheme Australia. This is a national scheme for production nursery growers and growing media businesses that operate in accordance with a set of national best practice guidelines. For more details on the Australian accreditation scheme, please visit the Nursery and Garden Industry website (<[www.ngia.com.au](http://www.ngia.com.au)>) to establish some best practice benchmarks.

As part of this scheme, Debco is audited every 6 months by an association representative who also collects samples of components for disease testing at an external plant pathology laboratory.

## Sharing Simple, Inexpensive Ideas From Nursery Producers®

### Ken Tilt and Jeff Sibley

Alabama Cooperative Extension Systems, 101 Funchess Hall, Auburn University, Alabama 36849-5649, U.S.A.

Nursery producers are farmers that are known for their independence and have made their successes through conservative money management and carefully “growing into their businesses.” Most nurseries are small family operations and not backed by large corporate investors. They have had to be very innovative and frugal in developing their businesses. The following is a collection of 23 practical, inexpensive ideas that nurseries have developed to help their nurseries compete successfully.

Some times descriptions of these innovations do not offer a complete vision of the ideas. Photographs of each of these ideas and some additional ones that time and space did not allow are available on-line at <[www.ag.auburn.edu/landscape](http://www.ag.auburn.edu/landscape)>; from this page look for the “Ideas” button.

The nursery industry is very important to the economy of Alabama. It is the number one economic agricultural crop. Over 850 nurseries and greenhouses generate \$250 million wholesale farm-gate dollars (\$1.4 billion ZAR) to the state’s economy. When these wholesale dollars flow through the retail, landscape, and maintenance sector to the consumer, the economic impact of the green industry is 1.9 billion dollars (\$11.3 billion ZAR).

Since most nurseries are small businesses and cannot afford the luxuries of potting machines or expensive equipment for moving large numbers of plants, they are forced to use their imagination to cope and minimize labor costs.

To compete with the more efficient larger growers, they look for niches and serve a specialty or local market. They also “make do” or use the resources they have available to cut costs and at the same time increase their efficiency and quality.

- 1) In earlier times, small nurseries could rightfully claim higher quality and offer that defining advantage to their customers. In those times, larger nurseries were known more for their plant skills than business skills. However, through competitive necessity large nurseries became more business minded and discovered one answer to quality. A business axiom was heeded that said, “If no one is responsible, no one is accountable.” From this business principle came the practice of dividing the nursery and assigning segments and responsibility for quality to responsible managers. Accountability yielded quality. This is a universal idea for big and small nurseries.
- 2) McCorkle Nursery, a mid-sized to large nursery in Dearing, Georgia, implemented the principle of “keep it simple” for their workers. Once required space was calculated for a crop, the nursery painted lines on the ground cloth of the growing pad to accommodate the planned number of pots. No repeated calculation and adjusting needed to be done. Most southern nurseries place their containers “pot-to-pot” until top growth shades the containers, avoiding excessive heat on the roots. Pots are then spaced. Lines

are drawn to allow the labor to fill pots between the lines, and appropriate space is allocated for spacing at a later date. Most labor in a nursery is involved in the repetitive task of moving containers from place to place. Anything that reduces this activity saves time and money.

- 3) An old idea adopted by most nurseries is building a manifold of multi-rows of evenly spaced irrigation heads fitted with water-breaker nozzles so that a wagon or cart of newly planted containers can stop briefly under this shower manifold and be watered thoroughly before going to the field container pads. There is no similar commercial product available. Each nursery creates their variation of this irrigation apparatus.
- 4) Most small nurseries cannot afford substrate mixers at a cost of \$5,000 to \$10,000 (\$30,000 to \$60,000 ZAR). They either purchase pre-mixed substrates or use a front-end loader to incorporate media components and additives. Nursery producers are notorious for finding someone else's junk and putting it to use. Old out-of-service cement mixers were salvaged and put back into service blending container substrates. They were too old for the abuse of mixing concrete but have greatly extended life mixing lighter materials, like pine bark and peat moss.
- 5) From the mixer to the containers works easier if you let gravity do the work. Nurseries have long used hoppers of various shapes and sizes to funnel substrates onto a potting bench. Many nurseries find this as efficient, or more so, than potting machines that require up to 13 people to keep them running smoothly. Certainly the smaller grower uses these hoppers to their advantage.
- 6) Rigsby Nursery in Ft. Myers, Florida, mounted a hopper on a truck bed and took it to the field to fill pot-in-pot containers. It worked well for their system.
- 7) Transplant Nursery in Lavonia, Georgia, used back yard engineering skills to make a potting machine. A conveyer system feeds substrate to a round hopper atop a merry-go-round/whirligig apparatus that has double offset circular wooden benches rotating around a central pivot pole. The upper inset ring has half-moon cutouts that allow the individual doing the potting to place the container on the lower outer ring and nest it into the half-moon cut-out and pull the gravity fed media into the pot from the central hopper above. After potting, the wheel is rotated and the pots are removed by another worker on the opposite side of the circle who puts them on a wagon to be watered-in beneath the irrigation manifold before going to the field container bed. (Many words to describe a simple machine; see web site.)
- 8) A "chuckwagon" was a covered, horse-drawn wagon in the days of the old west that was famous for carrying everything that was needed for a family or a group of cowboys to make a long trip across country. Bill O'Meara of Bochancee Nursery in Huntsville, Alabama, made this concept work in his nursery. He became



frustrated with the workers' constantly coming back from the field because they forgot something or needed to refill their spreaders or spray tanks. He developed several chuckwagons that held all the supplies needed for pruning, spraying, spreading fertilizer, or digging B&B plants. For instance, a fertilizer or herbicide chuckwagon would have large bins containing the chemicals with side openings so that the spreaders could be refilled in the field without returning to get a new bag. All the spare parts and tools are included on the wagon and are restocked at the end of the day. The backpack sprayer wagon would have 50-gal tanks of various pesticides and also included extra backpack sprayers, spare nozzles, safety equipment, materials data safety sheets, and a clean tank of water for rinsing the sprayers after spraying was completed.

- 9) Ideas emanate from frustration. One grower became very impatient when he or his employees spent long idle moments at the end of a garden hose filling a 50- or 100-gal sprayer. From the old steam engine train water towers, Transplant Nursery got the idea to build a wooden water tower holding a 200-gal tank with a simple commode floating ball valve to automatically refill the tank as a 4-inch line quickly filled the spray tanks.
- 10) Continuing in the water theme, many nurseries have installed high humidity mist chambers or put a couple of mist heads in the propagation cutting prep and sticking area to maintain the vitality of the cuttings while waiting to be stuck.
- 11) Another labor-saving idea for irrigation is to add one female adaptor about 1 ft up from the base of the irrigation riser so that if a taller or shorter crop is grown, the grower has the flexibility to easily replace or adjust the height of the riser without the hassle and expense of cutting and gluing a new riser or accepting a riser that was not the appropriate height for the plants being grown.
- 12) If you cover and uncover your plants with plastic or some other over-wintering material as temperatures fluctuate, you may appreciate the adaptation installed by Buddy Martin of Martin's Nursery in Semmes, Alabama. He installed permanent 6-inch nailer boards that serve as spacer guidelines as well as offer a stapling surface for easy covering and uncovering to adjust to fickle weather swings.
- 13) Each nursery is different and evolves a production system that meets their needs and the needs of their customers. Some nurseries like to fill all their containers and set them on the growing pads and pot the liners directly in the field. They have developed an auger with a 4-inch liner-sized head that can be set into a battery- or electric-tethered drill that is used to quickly dibble/drill holes for the planters to insert the liners.
- 14) The origin of lawn mower mounted pruners is unknown but widely adopted in some form. One or two height-adjustable mowers are mounted on a rolling base that is moved over the plants which prunes the plants evenly and quickly. Some permutations of this

device include mounting an electric or battery-powered hedge trimmer onto a bicycle chassis or wheelbarrow frame. Handles are adjusted to allow the proper pruning height.

- 15) There are large numbers of variations of container designs, and most can be worked successfully into a production program. Nested pots, or a smaller pot “nested” inside a larger base pot, offer plants such as rhododendron or dogwood trees, which have heat sensitive roots, protection from the extreme exposure to southern heat stresses. Rebar or metal poles are often run through the base container holes at perpendicular angles to offer stability to the nested plants.
- 16) Dr. Bryson James, a long-time member of IPPS and a nursery consultant, observed that if the feeder tubes, which often are chewed on by rodents or rabbits, were fed vertically through the lip of the base container and connected to the riser in the nested container, mice and rabbits were deterred from chewing.
- 17) Along these same lines, growers have often been disappointed when planting large quantities of seed only to find them missing due to night attacks by mice. Dr. Carl Whitcomb offered his cure to the problem by simply hanging a 2-inch × 4-inch frame from greenhouse supports and placing the flats across the frame, leaving no access for the mice.
- 18) Bob Rigsby of Rigsby’s nursery invented and patented the EFC container or raised hole container. It was a simple concept of moving the holes of the container about 1 inch above the base of the container creating a reservoir of water. This reservoir prevented rooting-down into the soil. It also reduced run-off and held fertilizer longer, increasing growth of some plants.
- 19) How do you carry large containers for 8 to 10 h a day or how do you manage a 10- to 50-gal container as you get older? The inventor of the Pot Hog and Oink is not a nursery producer but an allied company with an interest in nurseries. He developed this hand-truck-looking device with claws allowing leverage to easily lift and move large containers. He made hand-held grips that offer easy lifting without bending and with a grip that is kind to the fingers. See <[www.tmateo.com](http://www.tmateo.com)> to get the clear picture of this very helpful device.
- 20) Lancaster Farms, a very innovative nursery in Virginia, showed us a flat carrier while on an IPPS tour. It is a reverse “C-shaped” handle with a double-pronged fork on the bottom of the “C” and a handle on the upper side. The fork slides easily under the full length of the flat allowing the employee to easily carry a flat in each hand.
- 21) As with the earlier cited idea of marking container ground beds to avoid continued calculations and counting, other areas of the nursery can be similarly simplified. If you use the same pesticide concentration, fertilizer parts per million, container substrate mix, or growth regulator application rate, do not redo your work every

time you apply. Make a menu for your employees and give them pre-weighted volumes to eliminate that step. Use color codes and labels to make it simple and mistake proof.

- 22) It helps to have talented welders and builders on the nursery. The arduous task of covering greenhouses became easier when a nursery built a metal platform on skids that could be pulled by a tractor from greenhouse to greenhouse. Employees could easily be at the top of the houses to pull plastic and cover the houses.
- 23) Small nurseries should begin labeling everything as soon as they build the first greenhouse or container pad. It helps for inventory and directing new employees and customers to the right place. It is an obvious advantage but amazing that nurseries get so comfortable with their surroundings that they do not notice. Take pictures of your nursery sometime from all angles and see what you are missing in your own nursery.

Most of these ideas come from tours during plant propagators meetings. You learn and profit when you become an involved member of IPPS and follow the motto “Seek and Share.”

---

## Specialisation — Advantages and Disadvantages Compared®

### Peter Bingham

Kingfisher Nursery, Gedney Hill, Spalding, Lincolnshire PE12 0RU, United Kingdom

Over the past 50 years there have been a number of changes in the nursery trade. One of the most significant is the trend towards specialisation in one form or other. On my own nursery in the late 1970s we grew conifers, shrubs, roses, alpines, and heathers, covering over 1,000 cultivars, and sold to both wholesale and retail customers. The nursery now covers 10 times the area but we only grow heathers, less than 10 species, around 100 cultivars, three pot sizes, only two compost mixes, and are strictly wholesale only. Based on our own experience and those of other nurseries that I have visited, the following are some of my observations.

### ADVANTAGES

- **Simplicity** — Less complicated production schedules are easier to understand, easier to implement, and easier to monitor. Less skilled staff can still achieve good quality work.
- **Better labour planning** — Annual peaks and troughs are more predictable if the production schedule is simple.
- **Mechanisation** — The volumes of each job become large enough to justify investment in specialist equipment.
- **Knowledge** — It is better to focus on a specific skill or genus and become an expert than to be jack-of-all-trades and master of none.
- **Reputation** — If you can become the acknowledged expert in your field and the nursery can gain a reputation for quality and reliability the demand for your plants will increase.

time you apply. Make a menu for your employees and give them pre-weighted volumes to eliminate that step. Use color codes and labels to make it simple and mistake proof.

- 22) It helps to have talented welders and builders on the nursery. The arduous task of covering greenhouses became easier when a nursery built a metal platform on skids that could be pulled by a tractor from greenhouse to greenhouse. Employees could easily be at the top of the houses to pull plastic and cover the houses.
- 23) Small nurseries should begin labeling everything as soon as they build the first greenhouse or container pad. It helps for inventory and directing new employees and customers to the right place. It is an obvious advantage but amazing that nurseries get so comfortable with their surroundings that they do not notice. Take pictures of your nursery sometime from all angles and see what you are missing in your own nursery.

Most of these ideas come from tours during plant propagators meetings. You learn and profit when you become an involved member of IPPS and follow the motto “Seek and Share.”

---

## Specialisation — Advantages and Disadvantages Compared®

### Peter Bingham

Kingfisher Nursery, Gedney Hill, Spalding, Lincolnshire PE12 0RU, United Kingdom

Over the past 50 years there have been a number of changes in the nursery trade. One of the most significant is the trend towards specialisation in one form or other. On my own nursery in the late 1970s we grew conifers, shrubs, roses, alpines, and heathers, covering over 1,000 cultivars, and sold to both wholesale and retail customers. The nursery now covers 10 times the area but we only grow heathers, less than 10 species, around 100 cultivars, three pot sizes, only two compost mixes, and are strictly wholesale only. Based on our own experience and those of other nurseries that I have visited, the following are some of my observations.

### ADVANTAGES

- **Simplicity** — Less complicated production schedules are easier to understand, easier to implement, and easier to monitor. Less skilled staff can still achieve good quality work.
- **Better labour planning** — Annual peaks and troughs are more predictable if the production schedule is simple.
- **Mechanisation** — The volumes of each job become large enough to justify investment in specialist equipment.
- **Knowledge** — It is better to focus on a specific skill or genus and become an expert than to be jack-of-all-trades and master of none.
- **Reputation** — If you can become the acknowledged expert in your field and the nursery can gain a reputation for quality and reliability the demand for your plants will increase.

- **Buying power** — Pots, compost, and packaging can be bought in large volumes, which should bring the price down. Large volumes also help to make bespoke packaging or labels more viable.
- **Promotion** — By focusing on one crop, and getting a reputation for being good at it, you can build an image, whereas too many operations can cause confusion among potential customers.
- **Continuity of supply** — Simple records that can help to predict times of peak demand and larger volumes help smooth out the changing trends from one season to another. We have found this is one of the main reasons established customers remain loyal to us and new customers select us. Before we specialised we ran out too often and customers went elsewhere; some never returned.
- **Increased efficiency** — Bespoke machinery, bespoke growing facilities, well-tuned production schedules, and well-defined techniques all offer savings, as do larger batch sizes and streamlined despatch systems.
- **Seasonal breaks** — Whilst we try to balance the labour profile to keep regular staff usefully employed all year round, we have found advantages in having periods of reduced pressure to catch up maintenance and repairs, plan ahead, or even take holidays. When we grew more crops, there were very few breaks and often overlaps, which led to stress and errors, if prolonged.

## DISADVANTAGES

- **Vulnerability** — To pest and disease spread. Lack of rotation can lead to a build-up of pathogens. Resistances to control measures can develop.
- **Fashion change** — This can lead to reduced demand for your crop, which can lead to reduced prices.
- **Weather** — If your crop relies on impulse sales over a short season it can be vulnerable to reduced sales if the weather is wrong. Frost, drought, etc., can also have a serious impact on your growing crop.
- **Quality of life** — Specialisation can lead to a lack of variety of tasks. Mass production can become tedious for some, although there are always challenges to overcome — you can never know everything.
- **Seasonal peaks** — Can cause high labour demands, cash flow problems, and administrative stress.
- **Customers** — To sell more plants in a limited range you will need more customers or larger customers. More customers can increase delivery distances and hence costs. Larger customers can leave large gaps if they change suppliers.
- **Less flexibility** — Changing cropping can be more difficult due to lack of knowledge, outlets, equipment, and facilities.

## OVERVIEW

Specialisation can offer many advantages when it goes well but create problems if it goes wrong. It is wise to keep as many options open as possible and always consider the worst-case scenario before making the commitment.

Maintain flexibility in facilities and equipment where you can. Develop an interest in a range of plants that could offer alternatives whilst using existing facilities.

Economies of scale can still be achieved when growing a broad range of plants, provided they all fit into the same system, using the same compost mixes, equipment, facilities, and customer base.

One of the keys to successful specialisation is good record keeping and analysis. It is important to separate the winners from the losers before getting too committed. Unless you can get good percentage takes, produce high percentage first quality, and sell all you grow, there will be no advantage gained.

You should work to your strengths and those of your situation to develop a unique selling proposition. Your existing customers may be helpful in identifying your strengths and suggesting opportunities.

Your own personality should also be considered; unless you have a capacity for streamlined processes you may not enjoy running a specialist nursery.

## Adaptation — The Secret of Survival of the Biota Through Geological Time®

**Mary E. White**

Falls Forest Retreat, 318 Isaacs Lane, Johns River NSW 2443

Look at The Mallee and the eucalypt that gives it its name, and at the river red gums, the eucalypt icons of the Murray — closely related but so distinctly different because of their specific habitat characteristics — and you see how adaptation and survival are connected.

Co-evolution of the biota and the environment has been the story throughout the 425 million years that terrestrial life has been evolving on Earth. Natural selection has favoured the individuals best adapted to their current environments, and at times of change has promoted those with ability to adapt to the changing circumstances. Imagine the difficulties encountered by the first plants on the land — having a green algal ancestor and all that that implied; no longer surrounded and supported by water and able to absorb nutrients from it; exposed to evaporation, sunburn, and weather changes. Without the symbiotic help from fungi from the start they would never have made the transition and the world would have been a very different place today.

Australia's plant fossil record documents the evolution of its flora from the time of first vascular plants to modern-style vegetation. For most of that time the Australian landmass was part of the Gondwana super-continent, and the biota that it contained when it became an island continent 45 million years ago was Gondwanan. Evolution in isolation from that Gondwanan stock as the continent travelled northwards away from Antarctica has resulted in the unique Australian flora and fauna of today.

It is the evolution of flowering plants and their situation prior to separation, when the Murray Basin was forming, and while its modern landscapes were emerging in the island continent, that is of interest as background to this conference.

The evolution of the flowering plants and their rapid diversification and radiation into all parts of Pangaea (Gondwana and Laurasia were connected into one super-super-continent at the time) was facilitated by the impending break-up of the landmass. Rift valleys were developing between all the component continents, which were richly vegetated with forests of conifers, cycads, and ferns, under globally benign, warm, and wet climatic conditions. Early angiosperms were evolving but facing stiff competition for space. The rifts were disturbed regions with a great variety of different environments — from saline swamps being invaded by the sea, to freshwater swamps, areas of poor soils and of rich volcanic soils, sandy deserts, and changing topography and drainage patterns. Competition in them was much reduced. The old-style vegetation did not have the genetic flexibility or comparatively rapid reproductive cycles of the angiosperms. Flowering plants were able to adapt and produce new modifications that suited them to the new conditions. Then they could invade the established forests when rifts became seaways and changing climates as landmasses moved made conditions less suitable for the gymnosperm-dominated vegetation.



At 80 million years ago, when we take up the story of the Murray Basin, such a "mixed" flora, the Palaeoflora-mixta of Edgardo Romera, in which the different components have since been sifted and sorted according to their suitability to changed climate regimes, was in the making. This was an interesting time for the eastern half of the Australian continent when high volcanic mountains formed a wide belt along the margin and two huge river systems, the ancestral Murray and Darling, were part of the "Congo style" drainage, running south-west right across the eastern half of the continent and discharging into the Ceduna Depression within the rift system off the Nullarbor coastline. The huge amount of sediment eroded from the mountains was spread across vast riverine plains that were the forerunners of the freshwater deposits of the Murray Basin.

At 60 million years ago the rifting had developed to a stage where a seaway had developed from the west along most of Australia's southern margin. A connection to Antarctica remained through the Tasmanian sector. The Murray Basin was starting to sink and to accumulate sediments. A pollen flora from the Otway Basin just south of its margin reveals that this part of the rift was a centre for evolution of the Proteaceae and that sclerophyll types suitable for dry habitats were present as well as genera that are now confined to tropical rainforests. The association contained Antarctic beech and many taxa that are essentially cool temperate — so this was a palaeoflora-mixta.

At 45 million years, when final rifting between the Tasmanian peninsula and Antarctica was accomplished, Australia set off as an island continent, traveling northward at 6 to 7 cm per year. We know, from fossil floras in the dead heart of Australia at Lake Eyre, that the centre was forested and the mixed broadleaf — sclerophyll components were what now occur in remnant Gondwanan rainforests in subtropical and tropical regions. The genus *Eucalyptus* was present, with Casuarinas.

The movement of continents away from the Antarctic landmass, which remained straddling the South Pole, was to cause global climate change and set the world on a path towards an ice age. A circum-polar current developed round Antarctica after the Drake Passage opened between it and the tip of South America and when the gap between it and Australia's southern margin was wide enough. This current progressively prevented warm waters from equatorial regions reaching Antarctica and started a cooling that would lead to glaciation. Then, as ice built up and captured more of Earth's limited water budget, climates became drier. Sorting and sifting of the mixed floras that already contained plants with attributes suiting them to emerging environments proceeded. Natural fire became an environmental factor to which vegetation had to adapt as dryness increased from about 15 million years ago. By about 6 million years ago, Australia was already a fairly dry continent with rainforest remnants confined to still-suitable fefugia, the characteristic tough Australian vegetation widespread, and the wide-open spaces of the centre supporting grasslands and saltbush plains.

Glaciation of Antarctica was the driving force behind global climate change and progressive drying, and it was not until about 2.6 million years ago that the changes were sufficient to start the refrigeration of the North Polar regions. That marked the beginning of the Pleistocene ice age, in which we are living in an interglacial.

While all this was happening, the Murray Basin was undergoing physical as well as climatic changes. A minor marine incursion between 30 and 20 million years ago was followed by a major incursion and the Murravian Gulf occupied what is now

The Mallee until about 16 million years ago with fluctuating volume until about 5 million years. Marine sediments and coastal dune fields accumulated. Then a large section of terrain, the Pinaroo Block, started to rise, cutting the region off from the sea. The Pinaroo Block effectively dammed the river systems and Lake Bungunna formed and reached its full, vast, extent by 2.5 million years ago. It occupied a large proportion of The Mallee until 700,000 years ago, when it started to drain, becoming a number of smaller lakes in the process. Lake Tyrell, a major salt lake, is the largest remaining bit of Bungunna's lake bed.

Between 600,000 and 100,000 years ago the Mallee was established in its present form with its characteristic vegetation. Climatic instability was already pronounced and was to increase in the run-down to the last glacial stage of the ice age. While the centre was already acutely arid throughout the 75,000 to 35,000 years interval, good rainfall patterns persisted in the Murray Basin. At 55,000 years ago all the lakes in the Basin were full. The Willandra Lake system, fed by a tributary of the Lachlan, covered about 1000 km<sup>2</sup>. This "Mungo Lacustral Phase" was followed by an arid time of low and fluctuating water levels, becoming more pronounced as the last glacial stage of the ice age approached. Lakes on the Darling River anabranch had a similar pattern of lake-full to drying episodes. (While the Northern Hemisphere was experiencing glaciation, ice and snow in glacial stages, the fluctuations from glacial to interglacial times in Australia, in contrast, meant times of intensification of dryness and windiness and some decrease in temperature alternating with warmer, wetter times.)

It was the last glacial stage of the Pleistocene Ice Age, that had its peak at 20,000 years ago, that made an already dry Australia into the driest vegetated continent. The intensity of this stage was unprecedented. About 80% of the continent was under desert regimes with blowing sand and salt. The whole continent suffered with half the present-day rainfall and twice the windiness (and presumably increased fire frequency and intensity). The Murray Basin, suffering the full strength of the westerly salt-laden winds, was a salt desert. The major dunefields of today's deserts show the intensity of this phase, with linear dunes as high as houses running up to 300 km downwind. Siltation resulted in changes to river and tributary patterns and function, and the Willandra Lake system and Darling anabranch lakes were no longer fed by rivers except as overflow channels in rare times of flood.

The 16,000 years of recovery from this "desert island" phase established the landscapes and ecosystems of today's Australia. The modern climate regimes, orchestrated by ENSO, the El Nino-Southern Oscillation syndrome, perpetuate the dry to wet fluctuations that had been moulding ecosystems through millions of years.

What major adaptations have had to be made by the Gondwanan flora that Australia inherited when it set off as an island continent 45 million years ago! The foregoing account tells only part of the story and does not mention that this extremely ancient and stable landmass, Australia, has worn-out soils made from deeply weathered rock over 94% of its surface; or that it is the flattest land with least relief and is largely inward draining, accentuating the retention of sediment and salt. As a result it is a land of floodplains with saline water tables. (The huge Murray-Darling catchment has a single exit to the sea at Murray Mouth.)

Adaptation has been, and still is, the key to survival of a unique flora in a unique continent.

## Making Us “Future-Proof” — The Evolving Role of Horticulture<sup>®</sup>

**Elizabeth G. Heij**

Facilitator — CSIRO Sustainability Network, 14 Hakea Walk, Aldinga Arts-EcoVillage, Aldinga SA 5173

While this is not a scientific paper, it does examine the role of our science in the context of a profound socioeconomic change now gathering momentum around us. Although the process will be slow, this change will ultimately affect both the nature of our science and the way it is applied.

Let's reflect for a moment on the energy budget associated with our sector of “industrial metabolism” — the chain that begins in our research laboratories and ends with the application of our science in horticulture, agriculture, forestry, and conservation. Think, for example, of the lights, heating, and equipment used in laboratories, glasshouses, and propagation nurseries. Think of industrial chemicals, sterilizers, and fertilizers — of tractors, trucks, and other transport. There is little we do today that is not completely dependent on the burning or conversion of fossil fuels.

But fossil fuels are a finite resource — and, not only that, there is now almost universal scientific acceptance that their profligate use is bringing about rapid and potentially dangerous changes in the global climate. In addition, it is now widely believed, by oil scientists and geologists themselves, that we are at, or very near, the top of an oil production peak, with around half the world's extractable supply of oil already consumed and extraction costs rising as smaller and less accessible finds are tapped. With demand continuing to rise, especially in large developing nations such as China, these same scientists are forecasting an imminent “big rollover” in oil supply — from a buyers' market to a permanent sellers' market. In fact it may already be starting to happen. With around half the oil still in the ground, this is not the end of oil. It is, however, the end of cheap oil — and the geopolitics of the remaining oil-rich areas (such as the Middle East) can only add to the uncertainty of supply. Fuel switching from oil to natural gas and coal (supposing it can be made sufficiently clean for a “greenhouse” world) can delay only briefly the major adjustments society will be compelled to make in adapting progressively to a post-oil world.

So, beyond today's abundant availability of fossil fuels is an uncertain energy future that has been imagined in various scenarios (Holmgren, 2005; Fig. 1) that range from “techno-fantasy” (e.g., unlimited nuclear cold fusion) to a socioeconomic collapse in which our culture “goes under.” These two extreme scenarios both have frightening long-term implications for the planet and society. Most of the sustainability debate, however, is focused within the “green-tech stability” scenario in which we essentially maintain a steady (albeit somewhat reduced) level of energy usage by progressively moving to renewable sources such as wind, solar, tidal power, etc., as fossil fuel reserves are used up. This is a comforting and generally accepted scenario that confronts us with minimal change to our Western-developed-world lifestyles and industries. We want to believe it — but is it the most likely future?

There is a fourth scenario — envisioned by members of various “green” movements, Permaculture, and others who understand that human society functions within (not outside) the planetary ecosystem and is therefore subject to (not master of) the laws of ecology. In this scenario there is a “creative descent” down the energy

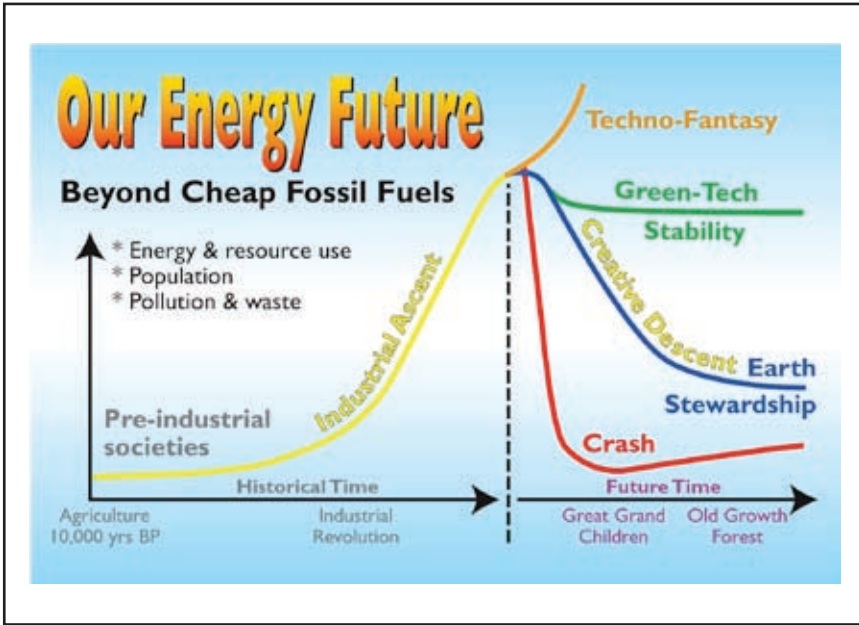


Figure 1. Future energy scenarios [after Holmgren (2005)].

demand curve — in effect a mirror image of the ascent triggered by the Industrial Revolution with its massive surge in technological innovation based on coal and oil. At the end of the descent is an “Earth Stewardship” scenario in which human populations are back in balance with the surrounding ecosystem; the use of energy and resources is matched to the natural capacity of the land people occupy; and societies are using their extensive ecological and technological knowledge to restore and maintain biodiversity for the well being of the entire ecosystem on which their own well being depends. The scenario is not one of returning to some “primitive” state, but of progressing towards a more knowledgeable, enlightened, and ecologically sound way of providing human “quality of life.” The ecologically sustainable plateau may seem a frighteningly long way down from the present day, but it is also a long way ahead in time. If the journey were to begin now, there would be ample time for human ingenuity to get us there without bringing on a socioeconomic “crash.”

Elements of all these scenarios can be found in the wide-ranging viewpoints and arguments of today’s “sustainability” debates. So which is the most likely? I personally hope the future lies somewhere in the region bounded by “green-tech stability” and “Earth stewardship.” Certainly, in the shorter term, the relevant strategies demanded by the two scenarios are closely aligned. In either scenario, as oil escalates in price and becomes less abundant we will not only need to switch to alternative energy sources, but also reduce energy demand.

Furthermore, as our awareness grows of the critical importance of biodiversity to the health of the planet and, in the end, the survival of human society, we will need to uphold biodiversity conservation as both a purpose and an ethic. The “Earth

Stewardship” scenario specifically emphasizes this purpose. Without encapsulating this same strategy, however, “green-tech” will never achieve “stability.”

So what has this to do with the future of plant propagation and the industries it serves?

The end of cheap oil means the end of cheap broad-scale mechanical cultivation, the end of cheap fossil-fuel-based fertilizers, and the end of cheap long-distance transport. In such a scenario, it is of genuine concern that we have (1) covered large areas of our most fertile, well watered land with giant, sprawling cities, (2) filled these cities with pretty but unproductive parks, gardens, and streetscapes of mostly exotic plants on which we lavish water and fertilizers, (3) have come to rely on growing food at remote locations and transporting it over long distances to where it is consumed, and (4) devoted large areas of our land to growing surplus crops and products that need long-distant transport to distant countries. In an energy-descent world, horticulture and productive gardening, together with some wood production, will need to become more local — shifting back into our cities where they have traditionally been in more sustainable societies.

As pointed out by David Holmgren, co-founder of the Permaculture movement, food security through retention of horticultural production within and close to cities has barely been on the contemporary planning agenda, while home gardening has essentially been ignored as irrelevant in the sustainability debate. For many urban residents, where food comes from beyond the supermarket is barely “on the radar.” Seemingly, we are happy to follow the European model of a high-density city that gets its food from somewhere else — unaware of different patterns of urban living such as those of Japan, China, and other Asian countries where cities have traditionally contained interspersed gardens and rice paddies. If food is produced in distant places, its supply is more vulnerable to risks that we cannot control (such as increased transport costs, natural disasters, and political crises). For urban residents aware of the fragility of the food supply system, home gardening is a practical activity that can not only provide much of a family’s fresh food but also improve the diet. Trends in the gardening media (e.g., television and magazines) suggest we are already starting to see a gradual shift in the balance of interest back towards home food production from purely aesthetic gardening.

Another relevant trend is the emergence and rise, here in Australia, of community supported agriculture (CSA) schemes, in which customers undertake to buy a regular box of in-season produce (fruits, vegetables, eggs, etc.) from one or more local small producers, thus providing the latter with a secure income and the ability to diversify the types of products they produce. While we may be more familiar with CSAs as relating to “small-farmer” businesses, such schemes can be set up to allow even domestic home gardeners to sell their seasonal surpluses into a neighbourhood market.

Although less familiar, the concept of urban fuel wood production is also relevant, particularly since our cities are, in effect, extensive “forests.” New tree plantings and conservation areas within or near cities need regular maintenance to reduce fire hazard, enhance ecological value, or improve the quality of fruit or timber. With careful management, there is much valuable wood that could be saved for fuel rather than being sent to land fill or fed into fossil-fuel-driven chippers and mulchers. Wood is a high-energy fuel, is greenhouse-gas neutral, and can readily be made available for higher-density neighbourhoods as smokeless charcoal.

And beyond the question of fossil fuel availability, it is also of concern that we continue to decimate the natural plant and animal biodiversity of the land we occupy — to clear fell the natural vegetation of the land on which we grow our crops, build our homes, and make our gardens; that we ignore the potential food plants of Australia’s native flora — the “bush tucker” that has supported indigenous Australians for thousands of years; that even in our own backyards we continue to replace precious remnants of the natural ecosystem with ill-adapted, water-hogging, alien systems harbouring potential weeds and pests. We have yet to learn the art of living WITHIN the dry and fragile Australian environment — caring for and using the biodiversity around us, and modifying only the minimum required to provide us with basic food, fibre, and shelter.

So, in summary, an energy-descent world will, over time, see us using the fertile, well-watered land on which most of us live to produce more of our own food and fuel. Likewise, a more “biodiversity-aware” world will see us better conserving natural Australian ecosystems at a range of scales from National parks down to our own suburban backyards. These changes in our thinking will, over time, change both the nature of the species and range of plants we propagate, and the nature of the enterprises that plant propagation serves. Some trends and opportunities that could be anticipated include:

- Evolution of our sprawling cities into mosaics in which a number of small, dense “metro” areas are surrounded by extensive village-like suburbs with thriving local food production and conservation activities at a range of scales and levels of community involvement;
- Use of a much greater variety of crops — and a far broader range of varieties of each crop — to fill the annual seasonal calendar of fruits and vegetables for home gardeners and CSAs across a wide diversity of local climatic and geographic regions;
- A shift in the balance of crop species from those targeted at export towards those targeted at local supply;
- Propagation of species (indigenous, exotic, and modified) for incorporation into new Australian-adapted farming systems designed to combat dryland salinity and cope with extreme rainfall variability;
- Propagation of indigenous and exotic xerophytes as food crops (desert “bush-tucker” species, cacti, etc.);
- A shift in plant breeding emphasis back towards flavour, food quality, and long production season, and away from the recent objectives of mass-scale commercial production — i.e., durability, transportability, long shelf life, and once-over harvesting;
- A rise in local sale of produce via “farmers’ markets” and CSAs;
- Convergence of “heritage seeds,” seed-saver organizations, and volunteer native-plant propagation with mainstream seed and nursery supply;
- Conversion of public open spaces such as parks into conservation areas or community fruit-and-vegetable gardens, opening up a range of possibilities for cooperative community engagement;
- Enterprises supplying home food producers and CSAs with a broad range of seedling vegetable transplants appropriate to the local seasonal calendar;

- Enterprises assisting homeowners to retrofit glasshouses to the exterior walls of their homes to capture winter warmth and extend the garden growing season;
- Enterprises based on “share-farming” the gardens of urban properties where residents are unable to do the gardening themselves — or providing training to those homeowners who want to learn the relevant skills;
- Enterprises supplying transplants of local provenances of native plants for productive use (food, fuel), specific habitats, or conservation purposes — and associated advisory and education services;
- Hands-on garden services based around food production or conservation gardening rather than lawn mowing etc; and
- Convergence of tree lopping and removal services with fuel wood and charcoal production.

While the future is of course unknown, the socioeconomic environment likely to emerge from a combination of some or all of these and other emergent trends will change the nature of plant propagation services — gradually moderating the current heavy emphasis on (1) exotic species for purely aesthetic uses, and (2) the mass, mechanized, monoculture of food crops.

Are these trends a threat to plant propagation industries? It depends to a large extent on how the world negotiates “peak oil” — and also on how rapidly we, in Australia, can become more aware of the ecosystems around us and learn to live like true Australians. Certainly, we can be confident that the changes will provide many opportunities for new and evolved plant propagation enterprises backed by sound plant science.

#### LITERATURE CITED

Holmgren, D. 2005. Retrofitting the suburbs for sustainability. CSIRO Sustainability Network Update 49:1-9 <[www.bml.csiro.au/SNnewsletters.htm](http://www.bml.csiro.au/SNnewsletters.htm)>.



## Horticultural Education as a Life-Changing Experience®

**Bronwen M. Rowse**

PO Box 34, Patumahoe, New Zealand

Photosynthesis is the link for all life, it is in fact the true meaning of life and much bigger than 42 (Adams, 1979). The simple conversion of the energy of the sun into plant food by green plants is the basis of life, as we understand it.

This understanding is shared by all humanity and has been for all time; every culture is linked to this simply for survival. Every living creature is bound by this special ability of plants. Our cultures all recognise this, remember harvest festivals? All societies hold this knowledge as common and it is a part of each human — it links us all.

The modern lifestyle, with urbanisation, overcrowding, and daily living stress, has meant for many people that these natural links are lost or obliterated. We all know we can unwind and feel better if we walk in a park or find a connection to green plants. Touch horticulture and you instantly connect with this link, to every other life form, and to your true self. Thus discovering a true connectedness or grounding, which engenders self-esteem and positive feelings.

Remember the first cutting you rooted, and how you felt like God? There is incredible personal power in that achievement, and one feels linked to all other growers and the universality of propagation and plant production.

As a student discovers and understands the natural links, they begin to see that they have some knowledge already and they yearn for more. How do you grow cannabis? Can I really produce my own tobacco? Where does sugar come from? Will this acorn really grow into an oak tree? And they look to add information and knowledge. They discover they can and want to learn, and it all keeps on making sense. Also they begin to walk straighter and with confidence.

Linking the training done to issues that appear in the media adds value to the learning offered, and if the students are able to offer extra information to public discussions they will gain respect and encouragement to learn more with each validation.

I had a group of students working on growing eco-sourced plants for a local territorial authority. We collected forest duff and seeds and cutting material from a bush remnant. We talked about provenances, the value and adaptations of plants for local habitats and ecosystems. There was an article on the news about another similar project. The students rushed in next day excited because that was what they were doing, and they had been able to explain it to their families. Each had found a use for their new knowledge.

Television gains great mileage from landscaping makeovers and where it has been possible for students to be involved in these projects they have gained personal standing. They also gain the status of knowing or having met personalities associated with public gardening.

We spent several days working in a garden, which is open for a major garden festival and the students became friendly with the garden owner. After one of our workdays a student commented that the public has to pay to visit the garden but we were there as friends and the owner made us home-cooked morning tea.

We built a food garden and grew heritage potatoes and kumikumi (curcubit), which provided links to the student's food heritage. It has been shown that growing the food we grew up with is an important factor in being sure of just who we are. A study of Italian immigrants into Australia showed that it took three generations of living in the new country before their gardens became indistinguishable from other Australian gardens.

We ran a class looking at native plants as a lesson in plant recognition and learning plant names. We learned the botanical name, the Maori name, and the common name(s). We described each plant. We looked for where it was being used as a landscape plant in our area. Then we researched ways the plant had been used by people, particularly native people. We found uses as diverse as medicinal, antiseptic, using soot for tattooing, cultural uses at births, and other events and spiritual religious uses.

Armed with this new knowledge and keen to discuss it with their family and grandparents/aunties they learned more, but also established a common link with people they had previously had difficulty communicating with.

Students that learn a little and find that their knowledge is of interest to themselves and to others just keep on learning more because of the rewards.

We had a tree of *Prunus campanulata* at our site and it is the first cherry to flower in the area. Knowing the name gave the students recognition as horticulturalists and taught them the value of their special knowledge. Often they would push each other to know and recognise the plants around them. I call this learning by stealth.

Students/people may be drawn into the world of horticulture by some aspect, think of orchid or fuchsia fanciers, school boys who love carnivorous plants or cacti, some who collect bizarre plants or just because plants are beautiful. If we can capture them on their own ground they may be lead willingly to great understandings and skills.

Each of us has, I am sure, experienced the horticultural moment that has taken our breath away. Remember Wordsworth and his daffodils.

"I wandered lonely as a cloud  
That floats on high o'er vales and hills,  
When all at once I saw a crowd,  
A host, of golden daffodils,  
Beside the lake, beneath the trees,  
Fluttering and dancing in the breeze."

I am absolutely sure that Wordsworth felt that moment viscerally, long before his brain could register, explain, or interpret it, and much later he captured it in words for the world to relive and enjoy. Horticulture and nature offer us these moments of divine interpretation, just when we least expect them, in a tiny flower or a giant tree. This is a massive example of horticulture as therapy for humans.

One of my major projects was to build a garden to be a therapeutic environment for people with issues of mental ill health. The project was built by the clients themselves, so they all gained therapy from working with plants and garden design. Many of them learned new skills as they worked on the project, such as design, installing posts, and bricklaying.

The concept of a therapeutic garden is to offer the visitor access to aspects of healing by simply being in the environment. There are four phases of healing as defined by Barnes (1998):

**The Journey.** The moving to seek change, achieved by choosing to visit the garden to initiate emotional involvement.

**Sensory Awakening.** When a person becomes stimulated by enchantment or fascination with an external factor. This was facilitated in the garden by offering a mix of familiar and new plants, colour, perfume, views, texture, light, and shade to transfix the individual.

**Self Awareness.** A person progresses from the experience of self awakening to self awareness, at this time they need a safe haven with space and maybe seating to spend time on self reflection associated with the new experience.

**Spiritual Attunement.** This is the new state, which may be reached by feeling at one with the world and the new understanding of it, enabling the person to move forward into daily life in a more happy and healthy state.

The garden we built was very user friendly, and it was close to our place of work, but the visitor had to actually take the time to enter the garden. There were no lost corners, all paths came back to the start or there was an option to exit via a closed gate to a much wider public park. We made three garden rooms each with a theme: one was biodiversity, one was edible gardening, and the other was based on the Koro (a native symbol of new life), and each room had seats. The rooms were linked with flowing areas offering bright flowers, bold foliage, and fragrance. At the centre of the site was a planting of native trees, with a set of stepping-stones through it inviting entry. The feeling and power of the garden became apparent on the opening day when it was being blessed by a Kaumatua (Maori leader), as the crowd followed him through the garden slowly they stayed in the garden instead of following the leader.

Horticultural training generally sets out to teach skills and knowledge to students but quite often it can lead to a major life change for the individual.

### **Life-Changing Experiences Arising from Horticultural Education**

- Gain self-esteem
- Gain employment
- Learning to learn/achieve
- Ability to enter further training/education
- Find connections/fellowship with peers and community
- Lifestyle skills
- New health

### **LITERATURE CITED**

- Adams, D.** 1979. *The Hitchhiker's Guide to the Galaxy*. Pan Books, London.
- Barnes, M.** 1998. Designing for emotional restoration: Understanding environmental clues, pp. 92–100. In: M.D Burchett, J. Tarran and R.A. Wood (eds). *Towards a new Millennium in People Plant Relationships* (conference proceedings). University of Technology Printing Services, Sydney.

# The Role of Clonal Propagation in Forestry and Agriculture in Australia<sup>©</sup>

**Peter Radke**

Clonal Solutions Australia Pty Ltd, P.O. Box 220, Walkamin QLD 4872

## INTRODUCTION

Clonal propagation in the form of grafting, marcotting, cuttings, or tissue culture is not new to forestry or agriculture. In Australia today, orchards of grafted citrus trees, banana plantations based on tissue culture stock, and softwood pine plantations based on cutting production are commonplace. Nowadays who would even think of establishing a commercial citrus orchard from seed? Nevertheless, there are some areas of forestry (e.g., hardwood eucalypts and acacias) and agriculture (e.g., new crops such as essential oils) in Australia in 2005 where clonal propagation is not yet established, and this paper is directed towards these crops.

Clones are identical copies of an individual. Clones have the same set of genes as each other. Seedlings on the other hand, while derived from the same parents, are different to each other and to the parents. Each seedling has its own unique set of genes.

In Australia, hardwood forestry plantations and agricultural crops such as tea-tree, are traditionally based on seedlings and so consist of trees which, while similar to each other, are genetically different. Variation to a greater or lesser extent is therefore a feature of seedling plantations, and so seedling plantations typically contain both vigorous plants and runts, fast growers and slower growers, well-formed trees and trees with poorer form.

A clonal plantation consists of trees that are all genetically identical to each other and which, barring differences due to varying environmental influences within the plantation, are all of the same vigour, form, and growth qualities.

## PLANTATION IMPROVEMENT

The extent of the variation exhibited in seedling plantations can be reduced, and the quality of the plantation thus improved, by using techniques such as careful provenance selection of the seed, and by rigorous culling of inferior seedlings prior to planting. In addition, many timber companies employ tree breeders to further improve the genetic character of their plantations through the development of seed orchards and controlled pollination. However, the degree of improvement that can be obtained is limited compared to clonal selection, and all the seedlings will still be different to each other to some extent.

In contrast, the clonal approach to plantation improvement is to identify an individual tree which is superior in some way (e.g., wood quality, speed of growth, tolerance of salinity) and to reproduce it clonally so as to plant a plantation of trees all identical to this superior individual.

## THE ADVANTAGES OF CLONAL PLANTATIONS

Clonal plantations confer many advantages over traditional seedling plantations.

Qualities selected by breeders for the mass-production of superior clones include:

- Increased **growth rate** or **vigour**;
- Increased **yield**;

- Superior **form/shape** (e.g., apical dominance for sawn log production);
- A particular **flavour** or **chemical composition** (e.g., in food crops);
- Superior **timber qualities** (e.g., strength, durability, density, paper quality);
- **Pest, disease, or drought** resistance;
- **Salt** tolerance;
- Suitability to specific **soil types** or **climatic zones**.

**Uniformity** is a natural feature of clonal plantations because the plants are genetically identical, and also because the clonal production process incorporates extensive sorting for age, development, height, vigour, etc. of the individual plants produced.

This, combined with the genetic superiority of the plants themselves, offers the plantation owner additional flow-on benefits over traditional seedling plantations, such as:

- Low levels of **runts and misses**;
- Reduced need for **re-planting**;
- Lower **stocking rates**;
- Lower plantation **establishment costs** (excluding the cost of the plants);
- Cheaper **harvesting costs**; and
- Increased **profitability** and **returns**.

## THE CLONAL PRODUCTION SYSTEM

The method of clonal production best suited to mass producing clones at a commercially viable price in very large numbers for forestry and agriculture is **cutting propagation**. The process of mass production of clonal crops by cuttings is vastly different from that of traditional seedling production, and this impacts on price and production scheduling, which in turn impacts on ordering timetables and payment schedules and structures.

As a simple comparison, seedling production involves receiving an order, taking the seed out of storage, and planting the order in one operation over a short period of time. The plants then grow-on for a few months until dispatch. The entire batch is sown at the same time, all the plants are the same age, and are all ready for dispatch at the same time. Thus seedling nurseries do not (in simplistic terms) require sophisticated technology or equipment, or highly trained staff, and they can operate on reasonably low levels of capitalisation. Seedling production lends itself to mechanisation, and is not particularly labour intensive.

In contrast, clonal cutting production is almost the exact opposite to seedling production.

**Motherstock.** Clonal cutting production is based on harvesting cutting material from motherstock such as hedge gardens. Motherstock requires constant intense management while in production mode so as to ensure maximum yield and optimum strike rate. When not being used for production motherstock still requires maintenance, albeit in a “holding pattern mode” so as to reduce maintenance costs. Since motherstock is expensive to maintain, clonal nurseries aim to obtain maximum yield from the minimum amount of motherstock, and to keep motherstock in continuous production mode without any “down time.”

**Lead Time.** Upon receiving an order, the clonal nursery may need to bring the motherstock back into "production mode" before starting to take cuttings, and this takes time. For a new crop, sufficient motherstock will need to be bulked up before mass production can begin in earnest. So, depending on the motherstock situation at the time of placing the order, there may be a significant lead time before production actually starts, and this needs to be taken into account at the time of ordering and determining delivery dates.

**Clonal Production Is a Continuous Process.** Clonal production is a continuous process of harvesting cuttings from the motherstock over a period of time. In contrast to seedling nurseries, cuttings are set continuously on a daily basis. Thus, in any one order, the plants are of different ages and will be ready for dispatch at different times. The older plants can be held in the nursery until all the plants are ready, but it is a feature of clonal production that the plants in the nursery and at dispatch will always be of varying ages from old to young.

**Technology.** Clonal propagation is well established in the softwood timber industry in Australia. The plant physiology of softwoods, however, is very different to that of hardwoods and this is reflected in the comparative ease with which clonal propagation can be conducted in softwoods, and the relatively low levels of technology and nursery capitalisation required. On the other hand, clonal propagation in hardwoods, and especially eucalypts, is a totally different ball game and is at the other extreme end of the spectrum regarding difficulty, technology, and capitalisation.

It is of little benefit to look overseas at the methods used in other countries such as in South America and Africa, since the economic and social climates in these countries dictate very different cost structures and their production processes are of limited application in Australia. Rather than copying a recipe from overseas, successful clonal nurseries in Australia have gone back to first principles and developed their own systems and processes which suit the particular economic and social climate under which we operate in Australia, not only in the technical field but also in the management and personnel areas.

Important factors that impact on clonal production in Australia compared to overseas countries are the high wages in Australia, the industrial relations system, the workplace health and safety laws, environmental laws, and the costs of our goods and services.

**Staffing.** Because of the level of expertise required of staff in clonal production, it is not an option for clonal nurseries to operate on a low core-level of staffing and bring in teams of casual staff in times of high demand, as often occurs in seedling nurseries. Clonal nurseries need to be able to retain their trained staff on a permanent basis year-round.

**Nursery Location.** Location is an important, and vastly under-rated, factor in the success of large-scale commercial clonal cutting production.

- Clonal cutting production depends on the harvesting of motherstock for the material used in the production process. In northern Australia, the tropical climate allows for year-round regrowth and continual harvesting of motherstock, and hence year-round production, compared to only the summer months in southern Australia.

- The time between setting the cutting and the plant being ready to plant in the field in northern Australia is less than half the time taken in southern Australia.

These two factors combine to allow for large, year-round production runs in tropical Australia, and work against locations in temperate southern climates. For large-scale production, freight to plantations throughout Australia is very cost-effective and is not an impediment to location.

**Partnerships.** For a successful clonal plantation programme, it is essential that there is a close relationship between the plantation owner, the breeder, and the nursery. While it is possible to propagate pretty well any plant clonally, some plants (and in particular eucalypts) are definitely much harder than others. Plant breeding and plant propagation are quite separate disciplines, and expertise in one field does not automatically convey expertise in the other.

It is important, therefore, that the breeder establishes a close relationship with the clonal nursery so that the breeding programme and the propagation trials run in parallel from the start. Where possibly millions of dollars ride on the outcome, it is critical to ensure that the integrity of the propagation trials is not inadvertently compromised by factors other than the inherent rootability of the clone.

**Cost Structure.** Clonal production is a highly labour-intensive, highly technical, and highly capitalised operation. Every cutting has to be prepared and set individually, and plants have to be sorted and moved through the system on an individual basis. The cost structure of clonal production bears virtually no comparison to seedling production, and as a rough ballpark, the price of clones is about 2 to 3 times the price of seedlings.

## CONCLUSION

It is not difficult to do the sums and see that, provided the clone has been carefully selected for its superior qualities, the additional cost of purchasing the plants for a clonal plantation is offset many times over by the flow-on savings and the increased returns, and that clonal plantations are very cost-effective operations.

Forestry and agriculture in Australia, through plant breeding and clonal technology, are poised for enormous growth as Australia strives to make maximum returns from limited arable land and to retain its share of the increasingly competitive global market.



## Propagation of a South African Arid Zone Plant — *Lithops*®

### Jac Duif

Staathof's Seed, PO Box 35851, Northcliff 2115 South Africa

I have decided to talk to you about *Lithops*, which are indigenous to South Africa and found mostly in dry rocky areas. *Lithops* are of the Mesembryanthemaceae family. The plants consist of a pair of thick fleshy leaves which make them very adaptable to dry and arid conditions. Flower colours of *Lithops* are mainly shades of yellow and white (Fig. 1).

South Africa has had some famous *Lithops* collectors, and one of them was Prof. Desmond T. Cole. He has written many papers and also a book titled *Lithops, Flowering Stones*. Two years ago, Mr. Frik du Plooy took over his whole collection, and he is still growing and maintaining it. Presently there are 37 known species in South Africa with over 200 subspecies and varieties. These were collected from over 700 documented locations.

The main reason for my decision to talk about this subject is that a friend of mine, Hans Blaquiere, started growing *Lithops* 2 years ago for the overseas market, and it really fascinated me. Hans bought a second-hand greenhouse and covered it with plastic and made the propagation beds, fitted a tap, and he was ready for his "retirement" project.

*Lithops* are easy to grow from seeds. They are best sown in spring and grown on through the summer and winter. Sow the seeds in a soil mix that drains well. A mixture of coarse sand and loam with coir or peat moss will do the trick.

Germination is very quick, and seeds will germinate in 5 to 6 days but growth is very slow. In nature quick germination is essential because the seeds have little time being exposed to water after rain.



Figure 1. *Lithops* in flower.

It is important that the seedlings are lightly shaded. Never expose them to direct sunlight. Although they come from arid areas, in nature *Lithops* mainly grow close to rocky outcrops, between stones and in cracks, which give just that bit of shade to protect them.

Watering is very important, and many beginners make the mistake of giving small amounts of water on a regular basis. This does not happen in nature where it is dry for a long time and then a good shower gives the plants a new burst of life. Therefore watering must be done only when the soil in which the seedlings are growing is dry. Then a good, deep soaking watering is necessary until the next time, maybe only after 3 to 4 weeks, depending on soil structure and climatic conditions.

A monthly liquid feeding with a well-balanced fertilizer will improve growth. Only use a weak solution, about 10% of normal strength.

After a year it is time to start transplanting the seedlings from the seed beds or trays into deeper trays, pots, or beds. A soil depth of about 15 cm is required. Try and keep the same soil mix recipe as this will help with your watering program.

Plant spacing in beds or trays is now about 30 mm apart, which means a density of around 1000 plants per m<sup>2</sup>.

Only give water when the soil becomes dry, and fertilise only once a month.

It takes 3 to 4 years from sowing to produce a saleable plant. Some species take longer. In Europe they require on average a plant with a minimum diameter of 25 mm. After the rains, just before winter one will notice that the plants look dry and shriveled up. No need to panic, as this is the time when new leaves are formed and the old ones are rejected and shed — just like a snake's skin. The new plants look clean and fresh again.

Commercial seeds are collected from plants grown under cover. Flowering time is usually during summer, after the first good rains have fallen. Because *Lithops* are not self-pollinators, the flowers are hand pollinated with a feather, one feather for each species so that no cross pollination occurs. In nature various insects do the job. A fertilised *Lithops* flower produces a seed capsule.

In nature the capsules stay on the plant and only open up when they get wet during rains. The tops open up and the raindrops may scatter part of the seeds around. When the capsules get dry they close up again and protect the remaining seeds until the next rain. Each capsule carries from 80 to 800 seeds depending on the taxon.

Harvesting and cleaning the seeds is relatively easy. The capsules are immersed in water and they open up. The seeds are dispersed out of the capsules and sink to the bottom. The dry matter is scooped out and the water is drained off. Seeds are dried and then stored, ready for shipment. The fact that the seeds were wet does not affect the germination at all, provided the seeds were dried quickly.

The lifespan of seeds is good, and usually fresh seeds give 85% germination. Tests have shown that *Lithops* seed lots lose about 4.5% of their germination capacity per year.

Commercially grown seeds are distributed throughout the world, mainly to collectors but also commercial growers who buy large quantities.

Frik du Plooy has a demand for about 20 million seeds per annum at present.

To sum up, *Lithops* may also be the plant to grow for your retirement, as:

- Little capital is required.
- They are easy to grow.
- You still have time to go on holiday and go fishing.

- Nothing is urgent with the cultivation of *Lithops*.
- The only time, which is crucial, is flowering time when the hand pollination has to be done, that is to say if you want to produce your own seeds.

They are marvelous little plants!

**Acknowledgements.** Thank you to Hans Blaquiére the *Lithops* plant grower and Frik du Plooy, the *Lithops* seed grower, for their assistance in preparing this talk.

---

## Propagation Strategies to Support a Wide Hybridization Breeding Program Within the *Chamelaucium* Alliance®

**Chris Newell, Digby Grows, and Chris McMullan**

Department of Agriculture and Food, Western Australia, 3 Baron-Hay Court, South Perth WA 6151

### INTRODUCTION

The activities of the Floriculture Group are focused on the selection and development of the West Australian flora with the object of improving industry capacity. Breeding within the *Chamelaucium* alliance is our most advanced activity, however we also work on a range of other species within genera such as *Grevillea*, *Geleznowia*, *Boronia*, *Banksia*, *Dampiera*, and a range of arid zone daisies.

Our breeding activities with the *Chamelaucium* alliance have focused on wide hybridization within a group of five related genera including *Chamelaucium* sp., *Verticordia* sp., *Actinodium* sp., *Pileanthus* sp., and *Darwinia* sp. The objective of the breeding program is to introduce novel cut flowers and amenity plants to industry. We assess hybrids on the basis of flower color, shape, and stem architecture as well as flowering time, productivity and post harvest performance. Some plants are tested for use in the flowering pot-plant section of the nursery industry and scheduling experiments are undertaken to assess nursery performance.

The Floriculture Group is in a unique position to undertake a breeding program of this type because Western Australia is the natural home of most of these plants. Plant propagation features prominently in the overall activities of the Floriculture Group. Our nursery is accredited to Nursery Industry Accreditation Scheme, Australia (NIASA) standards. The Group adopts and maintains a policy of industry best practice where possible including our plant tissue culture laboratory. Our greenhouse is a double-skinned plastic pneumatic inflated style with ridge venting and thermal screens.

In our plant tissue culture laboratory we have five laminar-flow stations and two sizable culture rooms. The lab is capable of a range of plant tissue culture activities including conventional micropropagation through to maintenance of cell culture lines for somatic hybridization experimental work. There is a strong focus on applied research and nursery integration.

The Floriculture Group also has a seed testing and grafting laboratory, which is used in conjunction with the breeding activities but also sustains stand alone research into these areas on a wide range of Western Australia plants. The Floriculture Group uses a research and development model, which includes plant selection,

- Nothing is urgent with the cultivation of *Lithops*.
- The only time, which is crucial, is flowering time when the hand pollination has to be done, that is to say if you want to produce your own seeds.

They are marvelous little plants!

**Acknowledgements.** Thank you to Hans Blaquiére the *Lithops* plant grower and Frik du Plooy, the *Lithops* seed grower, for their assistance in preparing this talk.

---

## Propagation Strategies to Support a Wide Hybridization Breeding Program Within the *Chamelaucium* Alliance®

**Chris Newell, Digby Grows, and Chris McMullan**

Department of Agriculture and Food, Western Australia, 3 Baron-Hay Court, South Perth WA 6151

### INTRODUCTION

The activities of the Floriculture Group are focused on the selection and development of the West Australian flora with the object of improving industry capacity. Breeding within the *Chamelaucium* alliance is our most advanced activity, however we also work on a range of other species within genera such as *Grevillea*, *Geleznowia*, *Boronia*, *Banksia*, *Dampiera*, and a range of arid zone daisies.

Our breeding activities with the *Chamelaucium* alliance have focused on wide hybridization within a group of five related genera including *Chamelaucium* sp., *Verticordia* sp., *Actinodium* sp., *Pileanthus* sp., and *Darwinia* sp. The objective of the breeding program is to introduce novel cut flowers and amenity plants to industry. We assess hybrids on the basis of flower color, shape, and stem architecture as well as flowering time, productivity and post harvest performance. Some plants are tested for use in the flowering pot-plant section of the nursery industry and scheduling experiments are undertaken to assess nursery performance.

The Floriculture Group is in a unique position to undertake a breeding program of this type because Western Australia is the natural home of most of these plants. Plant propagation features prominently in the overall activities of the Floriculture Group. Our nursery is accredited to Nursery Industry Accreditation Scheme, Australia (NIASA) standards. The Group adopts and maintains a policy of industry best practice where possible including our plant tissue culture laboratory. Our greenhouse is a double-skinned plastic pneumatic inflated style with ridge venting and thermal screens.

In our plant tissue culture laboratory we have five laminar-flow stations and two sizable culture rooms. The lab is capable of a range of plant tissue culture activities including conventional micropropagation through to maintenance of cell culture lines for somatic hybridization experimental work. There is a strong focus on applied research and nursery integration.

The Floriculture Group also has a seed testing and grafting laboratory, which is used in conjunction with the breeding activities but also sustains stand alone research into these areas on a wide range of Western Australia plants. The Floriculture Group uses a research and development model, which includes plant selection,

propagation (using both sexual and asexual techniques), nursery management, and assessment and commercial release.

### STOCK PLANT SELECTION AND PREPARATION

A breeding program is only as good as the capacity of the parents to contribute to the next generation. The breeding program selects parents on the basis of genotype, specifically its phenotypic attributes (e.g., flower color, flowering time, stem architecture, disease resistance, and availability). Populations of wild plants are identified through experience, professional connections, and within the bush-harvesting business, and Conservation and Land Management flora databases. Plants are collected under license. Selection of females and males normally takes place during the flowering season. At this stage of the life cycle it is possible to assess and select and capture the extent of variation within plant populations. Hidden characteristics, such as disease resistance or post-harvest life, are selected with random sampling techniques (Growth, 1998). As cutting material, it is poor at this stage of growth. It can be difficult to strike roots on cuttings taken at flowering time for many species and/or genotypes. Species in the *Chamelaucium* alliance are no different, and we may use grafting at this point. Because we have significant numbers of hybrids growing at our field station we are now in a position to select from our own F1 progeny as well. Producing superior parents through controlled crosses is now a significant part of our breeding strategy. Our objective is to have all females and males represented in the nursery so that logistically it is easier to manage the controlled breeding program. Some species, for example *C. megalopetalum*, require ongoing grafting for building up as stock plants as they otherwise don't thrive or survive. Rootstock selection for survival in pots is therefore critical. Such rootstocks may be different to those that would be used for in-ground cultivation. This process takes a maximum of 2 years and is part of the longer term planning within the breeding activity.

### BREEDING PROGRAM AND CROSSING ACTIVITY

We aim to undertake all of our crosses under controlled conditions and therefore need to prepare and emasculate the females and undertake pollen assessment using similar strategies to those used in seed testing. There are three broad types of crosses we undertake. The first is intraspecific crosses between selected genotypes of the same species. Crosses between two different species, such as *C. uncinatum* and *C. megalopetalum* are interspecific crosses. We call these crosses our Pearl or Gem series. For these plants we have a white (Pearl) and pink or purple (Gem) range and we select successful hybrids to fill a timeline and further develop the seasonal length that these flowers can be produced. We also have a program of producing wide intergeneric crosses between *Chamelaucium* and *Verticordia* sp. Our hybrids between *C. uncinatum* and *V. plumosa* are part of our Star flower series.

*Chamelaucium* sp. are pollen presenters and are prone to self fertilization. During flowering, pollen is deposited onto the style and easily collected and stored at this point. Emasculation must be done prior to the opening of the flower otherwise pollen will have been deposited on the style increasing the risk of self-fertilization. Collecting and storing pollen allows us to access the male half of the breeding equation at any time during the flowering season. Plants within the *Chamelaucium* alliance are all pollen presenters and pollen is available to be collected off of the tip

of the style immediately post anthesis. Females are emasculated and in a properly emasculated flower the style will continue to elongate and mature. At this point a small amount of prepared pollen is placed directly on the stylar dome thus completing the controlled cross. After about 28 days, the females are revisited and the previously crossed fruits are collected and labeled and sent to the plant tissue culture laboratory for early embryo rescue.

We use early embryo rescue techniques in our breeding program to ensure that any putative hybrids we produce have the maximum chance of surviving through to field assessment. In any given crossing season we average about a 10% return on our breeding investment. The first step is fruit preparation and culture initiation. The objective of this activity is to introduce viable embryos into sterile culture conditions. Once the embryos are removed from the fruit the testa oxidizes and needs to be removed otherwise normal germination is impaired. The second stage is stock plant management in vitro. The objective of the next stage is to produce rooted micro-cuttings as quickly as possible. Our aim is to produce rooted micro-cuttings capable of acclimatization in the nursery for each embryo we rescue. These rooted micro-cuttings are then progressed through the normal nursery handling system to harden off tube-stock and then planted out at our field station for assessment. We identified medium hypoxia in vitro as the principle limiting cause of poor rooting in our putative hybrid culture lines and developed a rooting protocol called in vitro soilless medium culture (IVS) (Newell et al., 2003). The IVS forward integrates an aerobic propagation medium into Stage 3 culture and fits into the overall propagation activity with the least amount of effort.

## ASEXUAL PROPAGATION

Clonally derived parental material is required in the breeding program so that suitable numbers of controlled crosses can be done for each selected cross.

Although *Chamaelaucium* can be propagated by various types of cuttings throughout the year, the preferred cutting material is semihardwood tips. Nodal cuttings can be used but these are best if they contain at least one actively growing axillary shoot. Cuttings typically strike 1 to 2 roots out of leaf axils after 3–6 weeks in an open, free-draining propagation mix on hot beds. Rooted cuttings are transferred into 100-mm tree tubes and are ready for field planting after a further 3–6 weeks. Root binding is a problem, particularly after nursery stock is held back in smaller tubes. In the field the problem manifests in two ways. Early symptoms include shoot twisting and breakage under windy conditions and finally foliage symptoms similar to nutrient deficiency. Plant death is primarily due to a collapse of the transpiration system during summer demand.

We use grafting to propagate bush-selected material, which is unsuitable to use for cuttings or for those genotypes that do not grow for long periods in pots. Rootstock is prepared as cuttings from selected genotypes. The typical stem diameter of the graft is less than 2 mm. Best results are achieved when the rootstock is actively growing and still small in the pot. The typical graft is a wedge or cleft graft. The scion is hand prepared and the finished graft is wrapped with parafilm tape before going out to the cloche to take.

The Floriculture Group has a small but active plant tissue culture laboratory with five laminar flow stations. Plant tissue culture technology is integral to the breeding project. It is also used for the selection and propagation of elite genotypes



of Australian plants with horticultural potential either as cut flowers or for the amenity nursery industry.

We are conducting an investigation into the possibility of using somatic hybridization to double up the chromosome numbers in some of our F1 hybrids to restore fertility and to continue the wide hybridization of genotypes within the *Chamaelaucium* alliance. This involves asexually fusing two protoplasts from two plants, which would normally not sexually hybridize.

## CONCLUSION

The Floriculture Group relies on the application of modern plant propagation practices for the selection, development, and breeding activity. Good propagation is the cornerstone to achieving the objective of the group, which is the development of novel plant products for commercial application. The group uses both sexual and asexual propagation techniques as well as conventional and sophisticated propagation technologies.

## LITERATURE CITED

- Growns, D. 1998. Developing a collection of genetic material. Comb. Proc. Intl. Plant Prop. Soc. 48:107–110.
- Newell, C., J.A. McComb, and D. Growns. 2003. The influence of medium aeration on in vitro rooting of Australian plant microcuttings. Plant Cell Tissue Organ Culture 75:131–142.

---

## Shoot Dieback of Geraldton Wax®

Naomi Diplock and Victor Galea

School of Agronomy and Horticulture, University of Queensland, Gatton Campus,  
Gatton QLD 4343

**Geraldton wax has been observed exhibiting signs of shoot dieback. This disease causes the plant to die back from the tips, often leading to whole plant death. This disease is a problem in all stages of production, but is worst during propagation when the young plants are most susceptible to disease.**

Isolation studies proved the fungus *Colletotrichum* sp. to be the cause of this disease. It was found that *Colletotrichum* sp. is not influenced by wounding; however a heat stress period and humidity are requirements for infection to occur. Fungicide trials indicated that a preventative treatment is needed for this disease to be managed. Control of this pathogen was found to be effective with the use of Amistar® when applied as a preventative treatment. This article describes a part of the experimental work carried out as an honours project: Shoot Dieback of Geraldton Wax (Diplock, 2004).

## INTRODUCTION

*Chamaelaucium uncinatum* Shauer (Geraldton wax) is one of Australia's most important native floriculture products. One of the limitations growers face when producing a high quality product is the limited amount of information available on diseases of this plant. There is a recognized need for pathogen identification and control of diseases of Geraldton wax (Fuss et al., 1992). Shoot dieback was observed



of Australian plants with horticultural potential either as cut flowers or for the amenity nursery industry.

We are conducting an investigation into the possibility of using somatic hybridization to double up the chromosome numbers in some of our F1 hybrids to restore fertility and to continue the wide hybridization of genotypes within the *Chamaelaucium* alliance. This involves asexually fusing two protoplasts from two plants, which would normally not sexually hybridize.

## CONCLUSION

The Floriculture Group relies on the application of modern plant propagation practices for the selection, development, and breeding activity. Good propagation is the cornerstone to achieving the objective of the group, which is the development of novel plant products for commercial application. The group uses both sexual and asexual propagation techniques as well as conventional and sophisticated propagation technologies.

## LITERATURE CITED

- Growns, D. 1998. Developing a collection of genetic material. Comb. Proc. Intl. Plant Prop. Soc. 48:107–110.
- Newell, C., J.A. McComb, and D. Growns. 2003. The influence of medium aeration on in vitro rooting of Australian plant microcuttings. Plant Cell Tissue Organ Culture 75:131–142.

---

## Shoot Dieback of Geraldton Wax®

Naomi Diplock and Victor Galea

School of Agronomy and Horticulture, University of Queensland, Gatton Campus,  
Gatton QLD 4343

**Geraldton wax has been observed exhibiting signs of shoot dieback. This disease causes the plant to die back from the tips, often leading to whole plant death. This disease is a problem in all stages of production, but is worst during propagation when the young plants are most susceptible to disease.**

Isolation studies proved the fungus *Colletotrichum* sp. to be the cause of this disease. It was found that *Colletotrichum* sp. is not influenced by wounding; however a heat stress period and humidity are requirements for infection to occur. Fungicide trials indicated that a preventative treatment is needed for this disease to be managed. Control of this pathogen was found to be effective with the use of Amistar® when applied as a preventative treatment. This article describes a part of the experimental work carried out as an honours project: Shoot Dieback of Geraldton Wax (Diplock, 2004).

## INTRODUCTION

*Chamaelaucium uncinatum* Shauer (Geraldton wax) is one of Australia's most important native floriculture products. One of the limitations growers face when producing a high quality product is the limited amount of information available on diseases of this plant. There is a recognized need for pathogen identification and control of diseases of Geraldton wax (Fuss et al., 1992). Shoot dieback was observed

during the summer months of 2002–2004 in south east Queensland. Geraldton wax was showing signs of shoot dieback exhibit shriveled brown leaves which remain attached to the plant for a long period of time before dropping naturally (Fig. 1), often followed by plant death. The aim of this project was to identify the causal agent of this disease, the environmental factors that may influence infection, and the potential for chemical control. This work was carried out over a series of experiments.

## GENERAL METHODS

Plant material showing signs of dieback was collected from a range of production locations in south east Queensland. This material was surface sterilised and placed on agar plates and incubated. Fungal colonies that grew were subcultured and preliminary identification was carried out on these. The original fungal isolations were *Alternaria*, *Rhizoctonia*, and *Colletotrichum* species. Inoculum was prepared from these cultures. These were then applied directly to plants with a hand sprayer. Plants were rated for disease over a period of 30 days.



**Figure 1.** Left: healthy cutting; Right: cutting showing symptoms of shoot dieback.

## EXPERIMENT 1

The objective of this experiment was to identify the pathogen responsible for the shoot dieback in Geraldton wax and to develop a method for inducing disease in previously healthy plants.

**Materials and Methods.** Plants were wounded by two methods (stem wound, leaf wound) or left intact (no wound). Some plants were placed in bags to increase humidity. Plants were placed in a growth cabinet with temperatures ranging from 38–45 °C during the day and 29–34 °C for the night phase. Plants were taken from the cabinet and bags were removed after 48 h and placed in the glasshouse.

**Results and Discussion.** Following Koch's rules, it was proven that the cause of the stem dieback observed in Geraldton wax is *Colletotrichum* sp. [tentatively identified as *C. gloeosporioides* (Penz.)], this supports the findings of Arnett (1987) who found *Rhizoctonia* and *Colletotrichum* sp. to be responsible for damping off in Geraldton wax in propagation. Symptoms on the plants took approximately 4 days to begin to show after inoculation.

Levels of dieback of Geraldton wax was greatest in treatments that were bagged for 48 h after inoculation, plants that were not bagged showed very little infection. Wounding of the plant had very little influence on levels of disease in all of the treatments. This is likely to be because most species of *Colletotrichum* sp. penetrate the plant directly, after the production of appressoria rather than entering through a wound (Bailey et al., 1992).

These trials proved that infection by *Colletotrichum* sp. on Geraldton wax can be induced in plants that are exposed to high temperatures, unwounded, and bagged to increase the humidity. Unfortunately these conditions are often met during propagation, making a favorable environment for disease to occur.

## EXPERIMENT 2

The objective of this experiment was to evaluate a selection of fungicides for their effectiveness in controlling shoot dieback of Geraldton wax when applied either before or after inoculation with *Colletotrichum* sp.

### Materials and Methods.

**Trial 1.** Application of fungicides after inoculation.

Unwounded Geraldton wax plants were inoculated with *Colletotrichum* sp. as described earlier. All plants were bagged and placed in the growth chamber for 48 h at 39–44 °C (day time temperature) and 27–29 °C (night time temperature). Plants were taken from the cabinet and bags removed after 48 h. Plants were sprayed with the following treatments (Table 1), then placed in the glasshouse and rated for disease over a period of 20 days.

**Table 1.** Fungicide treatments used in Trials 1 and 2.

Fungicide	Active constituents	Company	Rate used
Benlate® WP	500 g·kg <sup>-1</sup> Benomyl	Dupont® Australia Ltd.	0.1 g/200 ml
Amistar® WP	500 g·kg <sup>-1</sup> Azoxystrobin	Syngenta Crop Protection Pty. Ltd.	0.1 g/200 ml 0.1 g/200 ml
Banrot® 400 WP	250 g·kg <sup>-1</sup> Thiophanate- methyl, 150 g·kg <sup>-1</sup> Etridiazole	Scotts Australia Pty. Ltd.	0.1 g/200 ml
Pro-Teck®	(19.8% w/v) Copper sulfate Pentahydrate	Magna-Bon Corp. Florida, U.S.A.	0.2 ml/200 ml

**Trial 2,** Application of fungicides before inoculation.

Unwounded Geraldton wax plants were sprayed with the treatments as per Table 1. Forty eight hours later, plants were inoculated with *Colletotrichum* sp. as described earlier, bagged, and placed in the growth chamber for 48 h at 39–44 °C (day-time temperature) and 27–29 °C (night-time temperature). Plants were taken from the cabinet and bags removed after 48 h and placed in the glasshouse and rated for disease over a period of 20 d.

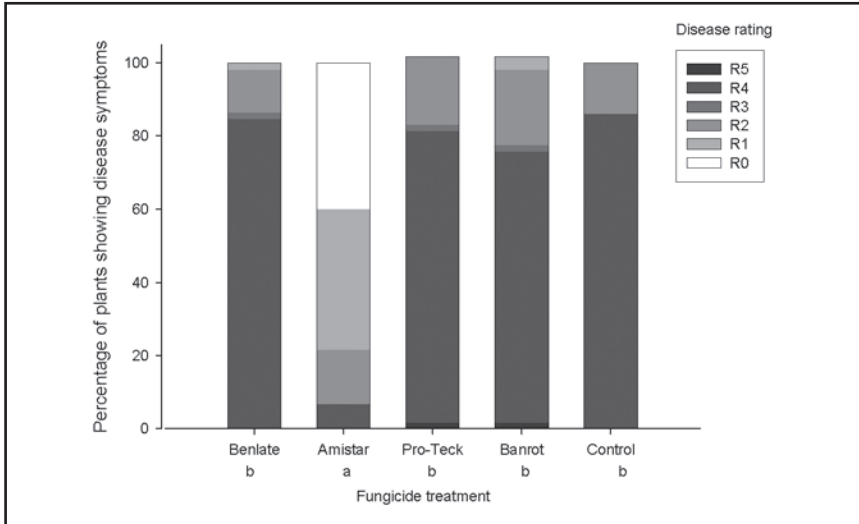
### Results.

**Trial 1.** Application of fungicides after inoculation.

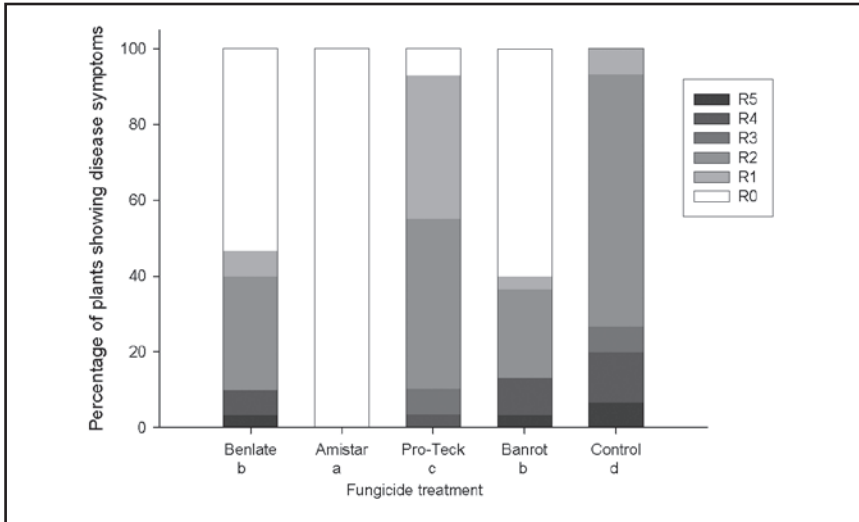
Levels of shoot dieback of Geraldton wax plants inoculated with *Colletotrichum* sp. were significantly reduced by the application of Amistar® 48 h after inoculation. All other fungicides were ineffective and not different to the untreated control.

**Trial 2.** Application of fungicides before inoculation.

Infection by *Colletotrichum* sp. on Geraldton wax was fully prevented by the application of Amistar® 48 h before inoculation (Fig. 3). Levels of shoot dieback were significantly reduced by the application of Benlate® and Banrot®. Pro-Teck® appeared to slow infection down and was significantly better than the control. The treatments when ranked from best to worst are as follows: Amistar® > Banrot® and Benlate® > Pro-Teck® > Control.



**Figure 2.** Effect of fungicide treatments (applied after inoculation) on infection by *Colletotrichum* sp. on Geraltion wax plants. (R0 = healthy, R1 = 1 mm spot on stem, R2 = lesion on stem >1 mm, R3 = lesion surrounding circumference, tip wilted, R4 = segment of shoot dead, R5 = entire shoot dead). Different letters indicate a significant difference ( $P = 0.05$ ) (Fisher's exact test SAS v8.2).



**Figure 3.** Effect of fungicide treatments (applied before inoculation) on infection by *Colletotrichum* sp. on Geraltion wax plants. (R0 = healthy, R1 = 1 mm spot on stem, R2 = lesion on stem >1 mm, R3 = lesion surrounding circumference, tip wilted, R4 = segment of shoot dead, R5 = entire shoot dead). Different letters indicate a significant difference ( $P = 0.05$ ) (Fisher's exact test SAS v8.2).

**Discussion.** Amistar® prevented disease when applied as a preventative treatment (Fig. 3) and significantly reduced disease when applied as a post-infection treatment (Fig. 2). However, it needs to be noted that Amistar is not currently registered for use on ornamental plants. Comparisons between the results from Trial 1 and Trial 2 indicate the need for the use of a preventative treatment in Geraldton wax propagation when temperatures are warm and humidity is high.

## CONCLUSION

Geraldton wax is one of Australia's most important native plants grown for the floriculture industry. Growers of this product face limitations in the area of plant protection from disease. Shoot dieback has been observed to cause significant economic losses in propagation and the field. The need for identification and understanding of pathogens of Geraldton wax has been discussed. The aim of this project was to identify the cause of the disease, control using fungicides, and factors, which may influence infection. Isolation trials and infection studies proved that shoot dieback of Geraldton wax is caused by *Colletotrichum* sp. It was demonstrated that wounding was not necessary for infection to occur, however high humidity and heat period are needed for infection to occur. Control of this disease can be achieved with the use of Amistar® when applied as preventative treatment.

## LITERATURE CITED

- Arnett, P.** 1987. The identification and management of damping-off pathogens affecting the vegetative propagation of Geraldton wax (*Chamelaucium uncinatum*). Forth Year Project. Gatton, University of Queensland.
- Bailey, J. A., R. J. O'Connell, R. J. Pring, and C. Nash.** 1992. pp.88–120. In: J. A. Bailey and M. J. Jeger, Eds. Infection strategies of *Colletotrichum* species. *Colletotrichum: Biology, Pathology and Control*. UK, CAB.
- Diplock, N.** 2004. Honours Thesis: Shoot dieback of Geraldton wax. School of Agronomy and Horticulture. Gatton, University of Queensland.
- Fuss, A. M., K. Seaton and B. Woods.** 1992. Proceedings of the National Waxflower Priority Setting Workshop, Adelaide, Department of Agriculture.

## Propagation of *Bougainvillea*<sup>®</sup>

### Brian Smith

Greenlight Nursery, PMB 16, Pacific Highway, Moorland NSW 2443

*Bougainvillea* is in the family Nyctaginaceae. The genus is comprised of 14 species of shrubs or small trees native to tropical and sub-tropical South America. Known as an evergreen woody scrambler (not a climber), with thorns enabling the plants to scramble over support. Leaves are alternately arranged on the stem. True flowers are cream and surrounded by three large, very showy bracts, which give the plants their decorative value, and occur in all colours, except blue.

*Bougainvillea* responds to feeding, watering, and hot weather and thrives on neglect. *Bougainvillea* can be planted exposed to salt-winds, they also thrive inland in hot, dry conditions, and in cooler areas in selected and sheltered sites.

*Bougainvillea* can be grown into trees, clipped to form hedges both small and large, grown as topiary, or espaliered. They can be grown as a standard, a ground cover, be multi-planted to create a spectacular flowering flowing massed effect, in hanging baskets to create the “wow” factor, or even be manicured into bonsai.

### PROPAGATION METHODS

Propagation of bougainvilleas can be achieved by a number of methods:

- Seed
- Grafting and budding
- Marcotting (air layering)
- Layering
- Cuttings

**Seeds.** Many taxa of bougainvilleas are sterile and very little research and development has been carried out — some self-seeding has occurred in North Queensland due to the hotter climate. The progeny results are variations of purple bracts with no improvements to existing cultivars. Genetic manipulation is the subject of ongoing research, especially in India. Seed propagation is of no commercial value, except for the possible production of new, smaller growing selections.

**Grafting and Budding.** Budding and grafting can be successfully used to propagate bougainvilleas. Three grafting methods that have been used are: approach, wedge, and whip and tongue.

Very little budding or grafting of bougainvilleas is done in Australia, but good examples can be seen in Asia where multiple cultivars are placed onto single rootstock to create topiary. Side veneer is another variation, with the stock cut and scion placed in larger side areas.

**Marcotting.** Marcotting, also known as air layering, was useful for plants that are difficult to propagate or where larger plants are required immediately. The technique is to select stems of pencil thickness, place a cut partially into the stem below a node, then dust with rooting powder and place something into the cut to keep it open, about a 2-mm gap. Wrap a generous amount of moistened sphagnum moss around the cut, then wrap the whole area in plastic and tie each end around the branch to keep moist. Roots should appear in about 1 month. The layered branch will need support due to the extra weight. Marcotting is no longer used due to more modern methods of propagation.

**Layering.** This is where a “branch” still attached to the parent plant is placed and pinned down into the soil. The branch has a small cut made below a node to induce roots with the cut made in the direction of the growing tip. This then becomes similar to a cutting, but the branch is still attached. This technique has no commercial value due to more modern propagation methods.

**Cuttings.** There are numerous sizes of cuttings, some may be: too long, too short, too fat, too skinny, too soft, and there’s the other, which is “just right.” The variations of cuttings will result in differing strike rates and in varying times taken. For optimal success I have found a cutting should be up to pencil thickness around 75 mm to 100 mm long with no less than three nodes, sometimes more to achieve the length. Some cultivars don’t produce cutting wood of the desired thickness, e.g., ‘Closeburn’ (syn. ‘Temple Fire’), so thinner wood is used, but make sure to harvest the thickest available wood of the particular cultivar.

The cuttings are prepared with the bottom cut just below a node, with two or more leaves left on but these reduced to half size. Show particular care in the bottom. The secateurs should be positioned with the cutting blade facing the cut, to produce a clean cut and reduce tearing of stem cells. If tearing or damage is done to the base of the cutting, this has to be cleaned up when taking off the side slice. The side slice involves taking off the bottom bud with a sharp knife. When this procedure takes place, immediately dip the cutting in rooting powder containing 16 g·kg<sup>-1</sup> IBA. To me it’s important to dip immediately, as when the cut is made the wound is open and there’s moisture and no sealing or drying has taken place. I feel the active ingredient in the powder will have more effect on producing roots.

The cuttings are then stuck. Cuttings are dibbled into 50-mm tubes that have a mixture of 3 perlite : 2 peat (v/v), with a slow-release tube fertilizer added. All tubes and trays have been washed in a copper sulfate solution. No sand is used in the mixture due to our prevailing drought conditions. The river has not been flushed and salt water is further up stream and on the coastal strip, so there is no quarry sand that is clean.

Immediately on planting, trays are watered to prevent drawing of moisture from the cuttings by the mix.

All cuttings are done at night. The next morning cuttings are placed into the propagation house, an igloo 6 m wide by 21 m in length covered in cellodim plastic sheeting. The house has a fall end to end of 5%; this enables control of hot air. As long as the bottom of the vent on the high end is higher than the top of the vent on the lower end, air movement is controlled. The house has no misting or fogging, and no bottom heat. The floor is constructed of approximately 75 mm depth of gravel, covered with black plastic sheeting and weed matting.

The benches are constructed of one concrete Besser™ block high with mesh benching covered in black plastic. The trays are hand watered each morning and only on very hot days is additional water applied for cooling. I believe too many propagation houses are kept too wet and too dark. Cuttings strike in around 15 days, but are kept in the house longer for a stronger root system to develop. Bougainvilleas are a cranky crop at this early stage. Strike rates are usually very high, even up to 95%. Not all taxa produce good strike rates.

Maybe some or all the methods and conditions are not necessary, but this is doing it “MY WAY”!!

I worked and trained under the late Mr. Paul Sorenson, “The Master Gardener,” and part of his teaching was saying as follows: “Pay full attention to small detail for perfection, but perfection is no small detail.”



## Grafting Australian Native Plants — 30 Years of Progress®

David Beardsell

Elite Australian Trees, 42 Viewhill Rd , North Balwyn VIC 3104

### INTRODUCTION

In the mid 1970s, the renowned botanist/horticulturalist David L. Jones introduced me to the concept of grafting native trees. Around this time, David successfully grafted the phytophthora sensitive *Hakea francisiana* onto the hardy eastern Australian rootstock *H. salicifolia* (Beardsell et al., 1982). Also around this time Ron Barrow and Bill Molyneux of Australflo Nursery, grafted a selection of red flowering gum, *Corymbia ficifolia* (syn. *Eucalyptus ficifolia*) onto *C. maculata* (syn. *E. maculata*), *C. calophylla* (syn. *E. calophylla*), and *C. gummifera* (syn. *E. gummifera*).

A number of other successful grafting programs were completed from the late 1970s onwards. These included grafting several hard-to-grow plants onto more hardy rootstocks, e.g., arid zone *Eremophila* sp. grafted onto *Myoporum* sp. and *Prostanthera* sp. onto *Westringia fruticosa* by the Australian National Botanic Gardens (Dawson, 1996), and Stirling Range *Darwinia* sp. onto *D. citriodora* by Doug McKenzie in Victoria (McKenzie, 1996). Dawson (1996) provides an excellent review of much of the earlier work on grafting Australian plants. Merv Hodge in Queensland also did pioneering work on grafting of *Grevillea* and other genera. Ray Kerr, David Myers, Annette Hallpike, and myself at the then Horticultural Research Institute did grafting experiments with a wide range of native plants in the early 1980s. Although the success rates were often low, we did establish grafted plants of *Allocasuarina torulosa* clones, *Thryptomene calycina* (onto *T. saxicola*), *Tristaniopsis laurina*, *C. ficifolia*, *Banksia canei*, *G. barklayana*, *Lophostemon confertus*, *Eucalyptus sideroxylon* (variegated clone), *Brachychiton* sp. and *H. francisiana* (Beardsell et al., 1982; Meyers et al., 1993; Meyers, 1993).

Much of the success in grafting Australian plants has been the suitability of hardy eastern members of genera, which can be used as rootstocks for related difficult-to-grow species from Western Australia and elsewhere. However there has also been a need to develop grafting methods for species, which cannot be propagated by cuttings. There are many recognised outstanding specimens of *Eucalyptus*, *Corymbia*, *Angophora*, and *Lophostemon confertus* in this category. Consequently from 1993–1996, Michelle Bankier and I at the Institute for Horticultural Development did grafting trials with a range of *Eucalyptus* sp., *C. citriodora*, and *A. costata*. Grafting success was further improved on most species, however commercial success rates were not achieved. In addition, we were unable to successfully graft an outstanding clone of *A. costata*. In 1998, Fon Ryan successfully grafted this species (Ryan et al., 2000).

Between 1997 and 2003, I continued trials using completely new methods of rootstock and scion manipulation, and achieved 100% success rate on *E. leucoxyton* subsp. *megalocarpa*, *E. melliodor*, *E. sideroxylon*, and weeping standard trees of *B. integrifolia*. Most previous grafting programs on Australian plants centred on cleft or wedge grafts, which is a crude method. I believe that many of the poor graft unions observed in earlier work were due to the poor matching of cleft grafts.

## COMPACT GRAFTED TREES

An unforeseen benefit of grafting Australian trees has been consistently observed compact growth. In some cases, this has been due to rootstock effects. For example, *C. maculata*, which forms compatible graft unions with *C. ficifolia* clones, appears to reduce height and vigour by approximately half compared to *C. calophylla* rootstocks.

Similarly self-pollinated seedling rootstocks of *E. leucoxylon* subspecies *megalocarpa* dwarf the parent clone. Grafting per se onto outcrossed seedling rootstocks at least in *C. citriodora* also appears to reduce vigorous extension growth, which is characteristic of the juvenile phase in this species, and also increases the angle between lateral branches and the main stem which may lead to structurally sounder trees. Early flowering is also a feature of grafted trees such as *C. ficifolia* and *E. leucoxylon* clones.

There are a large number of successfully grafted plants of a wide range of Australian trees and shrubs now known to be greater than 20 years of age. These include selections of *C. ficifolia*, *Lophostemon confertus*, *B. canei*, and *H. francisiana*. Earlier rumours of long-term graft incompatibility in Australian plants seem unfounded as long as rootstocks are closely related to scions. While much more work is to be done, especially on different scion/rootstock combinations to alter size and vigour, we are on the verge of a revolution in Australian landscapes using clonally propagated elite native trees, and the unpredictable and unacceptable seedling variation will become a thing of the past (Beardsell et al., 1993; 1994).

**Acknowledgments.** I would like to thank Bill Molyneux for many valuable discussions on Australian trees, Wes Fleming, Paul Croxton and Kathy Mullins for encouragement, Michelle Bankier for dedicated and skilful assistance, and Fon Ryan for grafting *Angophora costata*.

## LITERATURE CITED

- Beardsell, D.V., D.L. Jones and R. Kerr. 1982. Grafting of *Hakea*. Austral. Plants 11:346–350.
- Beardsell, D.V., P. Yau, and P. Harrison. 1993. Elite native street and park trees. Austral. Hort. 91:48–53.
- Beardsell, D.V., P. Yau, F. Horlock, and M. Bankier. 1994. The urban eucalypt in crisis. Austral. Hort. 92:42–46.
- Dawson, I. 1996. Proceedings of the IV national workshop for Australian native flowers, 28–30 Sept. 1996, University of Western Australia, Perth.
- Hodge, M. 1990. Grafting native plants. Austral. Plants 15:369–376.
- McKenzie, D. 1996. Growing *Darwinia* — Grafted for reliability. Austral. Plants 18:239–244, 260–261, 278.
- Meyers, D. 1993. Thryptomene — The grafting of Grampians Thryptomene. Austral. Plants 17:79.
- Meyers, D., D. Beardsell and R. Kerr. 1993. Grafting the forest she-oak. Austral. Plants 17:175.
- Ryan, F., D. Beardsell and M. Bankier. 2000. Cloning success with *Angophora costata*. Austral. Hort. 98:46–49.

# Grafting Tissue Cultures Directly onto Nursery Grown Stock<sup>®</sup>

**Jonathan Lidbetter and Pauline Cain**

NSW Dept of Primary Industries, Gosford Horticultural Institute, Locked Bag 26, Gosford NSW 2250

## INTRODUCTION

Tissue culture is a useful tool to rapidly multiply material, rescue embryos from novel hybrids, generate haploid plants, or genetically engineer crops. In association with heat treatment and *in vitro* grafting it can be used to eliminate viruses and viroids from infected material. It provides a year-round supply of vegetative material that can be quickly multiplied to provide large numbers of propagules. In some cases it can be used to restore juvenility, often in turn increasing the propagation success of cuttings taken from tissue-culture-propagated motherstock.

One of its limitations is the relative difficulty in deflasking plantlets of many species. This can be due to poor rooting of plantlets or slow root growth of taxa in association with the very soft nature of tissue cultured plants.

Grafting tissue cultures *in vitro* or directly onto nursery grown stock are two methods to potentially overcome these problems. Providing a vigorous or well-developed rootstock allows for rapid development of the scion providing a much quicker growing plant than can be achieved through conventional deflasking.

## IN VITRO GRAFTING

*In vitro* grafting has been widely used both in research laboratories and commercially. Three examples are summarised below:

- Navarro (1990) succinctly reviews the protocols and benefits of shoot tip *in vitro* grafting (STG) in the elimination of virus infection whilst maintaining the adult nature of scion material, a procedure adopted worldwide.
- Espen et al. (2002) showed *in vitro* grafting of internodes allows a rapid evaluation of the "localised type" of graft incompatibility, as exhibited by some pear and quince combinations in as little as 30 days. Using this technique for other woody perennials has the potential of elucidating the causes of incompatibility, as well as significantly reducing the time to confirm incompatibility of new combinations, saving valuable time in the search for appropriate combinations.
- Senthil et al. (2004) used *in vitro* grafting onto seedlings germinated in culture as a means of ensuring rooting and survival of genetically modified chickpea after deflasking.

Of these examples, ensuring successful deflasking is where direct grafting onto nursery stock has the most likely potential benefit over *in vitro* grafting. Reducing the number of steps requiring a completely aseptic environment potentially saves laboratory space, time, and money.

## PROPAGATING DIFFICULT-TO-ROOT TISSUE CULTURES

Grafting tissue cultures directly onto nursery-grown rootstocks offers a very simple solution to deflasking difficult-to-root tissue cultures. Often in the development of new taxa through embryo rescue, mutagenic treatment, or genetic engineering as little as a single plant is needed to be deflasked to allow further propagation or breeding.

### CASE STUDY — *ERIOSTEMON AUSTRALASIUS*

We first tried this technique with *Eriostemon australasius*. Conventionally, this species is regarded as both hard and slow to strike by cuttings with only a few clones propagated in the nursery trade. As part of research introducing new clones to cultivation we selected new adult forms based on flower and habit characteristics and attempted to propagate them by cutting and tissue culture. The percentage rooting of cuttings was very low and very slow. In contrast the introduction to tissue culture was more successful. Bushfires destroyed a number of the original plants and all that remained of the clones was material established in culture. Very low root strike in vitro hampered deflasking and an alternative method had to be developed.

Using simple leafy-scion grafting techniques and allowing for the softness of tissue culture material a method was developed to graft tissue cultures directly onto nursery-grown seedlings. As tissue cultured material is often only 0.5–2 mm in diameter, scalpels or preferably razor blades were used to prepare the rootstock and scion.

A simple top wedge graft was used and the union wrapped in a fine piece of Glad-wrap® or Nescofilm®. Young vigorously growing rootstocks were selected and the wedge was made in the transition zone between soft tip and semihardwood and any branches or axillary buds were removed. Scions were kept in their jars until required then selected for stem thickness and trimmed to reduce the level of very soft tissue usually to 1–4 cm long. Grafted plants were misted with distilled water or 0.2% Amistar® solution to maintain turgor and reduce the risk of fungal infection, then sealed in a polyethylene bag, and placed in a lit growth room at 25 °C yielding 60  $\mu\text{mol m}^{-2} \cdot \text{s}^{-1}$ . After 2 weeks the light level was increased to 90  $\mu\text{mol m}^{-2} \cdot \text{s}^{-1}$ . After 3 weeks the tie was removed if necessary and new axillary buds on the rootstock were removed. Grafted plants were transferred to a shaded mist bench and progressively hardened off.

Success rate was variable depending on the scion and rootstock quality and seasonal climactic conditions. Invariably it was harder to harden off plants during mid-summer. In all 60/129 (47%) grafts were successful including a number of plants rescued from contaminated jars. In some batches success reached 100% (Lidbetter et al., 2002).

Plants originating from tissue cultures of adult origin flowered within 9–15 months of grafting effectively maintaining the same ontogenic age as the source plant similar to that observed in citrus (Navarro, 1990). Tissue cultures of seedling origin still took just over 2 years to reach flowering as per seedlings germinated in the nursery.

### OTHER SPECIES

At Gosford Horticultural Institute we have also used this technique to rapidly deflask new *Boronia* hybrids germinated in vitro following embryo rescue. Grafted plants flowered within 20 months.

Alexander and Lewis (1998) reported the use of this technique to graft new avocado hybrids germinated *in vitro* following embryo rescue. Vic Hartney (pers. comm.) has also reported using this technique in the development of cocoa in Malaysia.

Pniewski et al. (2002) have also used this technique to deflask lupins after noticing a severe decline in rooting success after only four to five subcultures *in vitro*.

The only obvious reason limiting the potential species with which this technique can be used is the issue of large rootstock stem diameter. However, other grafting techniques can be used to overcome this problem.

## REDUCING DELAYS IN QUARANTINE

One of the major delays to the introduction of new plants into Australia from overseas is the period that they spend in quarantine. Significant time and hence cost savings can be achieved using this technique, particularly for ornamental plants and potentially for field fruit crops. For instance, in the case of most ornamentals, once an import permit has been acquired, the import fees paid, satisfactory documentation presented, simple logical procedures followed, and an inspection completed showing the tissue cultures are free from bacteria, fungi, insects, and disease symptoms, the material may be released with no further impediment. In contrast, all propagation material other than tissue cultures face obligatory methyl bromide fumigation prior to propagation and 3 months in an approved post entry quarantine facility with the attendant costs of AQIS inspection (AQIS-ICON 2005).

For fruit crops the only difference between tissue cultures and all other propagation material is the requirement for methyl bromide fumigation of nontissue cultures. Both tissue cultures and all other propagation material require the same prolonged period of growth and testing in post-entry quarantine. However with greater acceptance of overseas virus test results and accreditation of overseas tissue culture laboratories potential exists for a reduction in the testing needed in Australia. Similarly, the requirements for interstate transfer of tissue cultures are lower than for other material and tube stock.

## OVERVIEW

The procedure of grafting tissue cultures onto nursery grown stock opens up possibilities for plants that are difficult to root *in vitro*, from breeding programs and genetic engineering research, to crops that don't currently have a satisfactory root initiation or deflasking protocol developed. This technique has already been utilised for crops from herbaceous legumes to small trees from a wide range of families (Rutaceae, Lauraceae, Fabaceae, Sterculiaceae). Furthermore if a crop is routinely grafted to confer disease resistance or vigour, both grafting and deflasking can be combined in one simple operation. The minimisation of time delays and costs associated with quarantine is another potentially significant benefit for the nursery industry.

## LITERATURE CITED

- Alexander, D. McE. and W. J. Lewis. 1998. Grafting and budding fruit and nut trees: A practical guide. CSIRO Publishing, Collingwood, Vic, Australia.
- AQIS-ICON. 2005. AQIS Import conditions website: <[www.aqis.gov.au/icon32/asp/ex\\_querycontent.asp](http://www.aqis.gov.au/icon32/asp/ex_querycontent.asp)>.
- Espen, L., M. Cocucci, and G.A. Sachi. 2002. Vascular tissue regeneration *in vitro* grafts of pear/quince. *Acta Hort.* 596:431–435.
- Hartney, V. (pers. comm.) Malaysian Cocoa Board, Rosevalley, 740 Summervilles Road, Thora, NSW 2454.

- Lidbetter, J., T. Slater, P. Cain, M. Bankier, and S. Vujovic. 2002. Grafting *Eriostemon australasius*. RIRDC Publication No.02/140.
- Navarro, L. 1990. Shoot-tip grafting in vitro of woody species and its influence on plant age, pp.117–123. In plant aging: Basic and applied approaches. Pikenum Press, New York, New York.
- Pniewski, T., J. Kapusta, and A.B. Legocki. 2002. In vitro micropropagation of four lupin species. *Acta Physiol. Plant.* 24:417–424.
- Senthil, G., B. Williamson, R.D. Dinkins, and G. Ramsay. 2004. An efficient transformation system for chickpea (*Cicer arietinum* L.). *Plant Cell Rept.* 23:297–303.

---

## "Long John" Grafts<sup>®</sup>

**Allen Gilbert**

Gilbert & Cosgrove P/L, 49 Coolangatta Road, Adventure Bay TAS 715

### INTRODUCTION

Usually when short scions (graft pieces) are grafted to any fruit tree or rootstock the scions used have only leaf buds evident. When the graft "takes" it will only produce leafy shoots, which form branches. It can then take from 3 to 5 years or more before that branch will be large enough or mature enough to produce significant amounts of fruit. This is especially so if spur pruning is the method of pruning used.

I have found that by using a different technique, selected scions with flower buds already formed on them can be encouraged to produce lots of fruit in the same season that they are grafted to the tree. The new approach I will describe developed from the success I achieved by using short scion pieces with flower buds attached, and grafting them onto apple trees. These produced some fruit on those graft pieces in the same season that the grafts were done, but I found that the longer pieces resulted in a heavier crop in the first season.

### THE "LONG JOHN" TECHNIQUE

The technique of using long scions (20–100+ cm) together with a plastic sleeve has developed as a result of experiments over a period of 15 years. It was originally used for grafting a 'Granny Smith' apple scion (*Malus domestica* 'Granny Smith') onto an established green/purple fruited 'Northern Spy' (*M. domestica* 'Northern Spy') apple tree in July 1998. In this first attempt, I used an unpruned single 1-year growth scion (lateral) over 1 m long that contained leaf buds but no flower buds or spurs. The graft piece was positioned almost horizontally on the tree and was covered with a plastic sleeve, moisturised inside, sealed at the top end, and open at the base to allow air circulation. The warming aspect of the sleeve and the length of scion used is the reason I started calling these longer scions "Long Johns."

The attached scion formed spurs with flower buds along its entire length in its first season of growth (1998–1999). During the 1999–2000 season it produced many green apples that had developed from these formed flower buds. The weight of the apples bent the branch downward and it was easy to pick from the ground and the grafted branch stayed bent in the same position even after the fruit was picked adding to the low-profile shape of the tree. This low-profile shape is also characteristic of the little or no pruning approach I have been developing (Gilbert, 2001).

I have also grafted lengthy unpruned single scions on plums, prunes, cherries and pears with great success. It is worth noting, however, that if the attached scion is pruned at the tip before or after grafting occurs, flower bud and spur formation

- Lidbetter, J., T. Slater, P. Cain, M. Bankier, and S. Vujovic. 2002. Grafting *Eriostemon australasius*. RIRDC Publication No.02/140.
- Navarro, L. 1990. Shoot-tip grafting in vitro of woody species and its influence on plant age, pp.117–123. In plant aging: Basic and applied approaches. Pikenum Press, New York, New York.
- Pniewski, T., J. Kapusta, and A.B. Legocki. 2002. In vitro micropropagation of four lupin species. *Acta Physiol. Plant.* 24:417–424.
- Senthil, G., B. Williamson, R.D. Dinkins, and G. Ramsay. 2004. An efficient transformation system for chickpea (*Cicer arietinum* L.). *Plant Cell Rept.* 23:297–303.

---

## "Long John" Grafts<sup>®</sup>

**Allen Gilbert**

Gilbert & Cosgrove P/L, 49 Coolangatta Road, Adventure Bay TAS 715

### INTRODUCTION

Usually when short scions (graft pieces) are grafted to any fruit tree or rootstock the scions used have only leaf buds evident. When the graft "takes" it will only produce leafy shoots, which form branches. It can then take from 3 to 5 years or more before that branch will be large enough or mature enough to produce significant amounts of fruit. This is especially so if spur pruning is the method of pruning used.

I have found that by using a different technique, selected scions with flower buds already formed on them can be encouraged to produce lots of fruit in the same season that they are grafted to the tree. The new approach I will describe developed from the success I achieved by using short scion pieces with flower buds attached, and grafting them onto apple trees. These produced some fruit on those graft pieces in the same season that the grafts were done, but I found that the longer pieces resulted in a heavier crop in the first season.

### THE "LONG JOHN" TECHNIQUE

The technique of using long scions (20–100+ cm) together with a plastic sleeve has developed as a result of experiments over a period of 15 years. It was originally used for grafting a 'Granny Smith' apple scion (*Malus domestica* 'Granny Smith') onto an established green/purple fruited 'Northern Spy' (*M. domestica* 'Northern Spy') apple tree in July 1998. In this first attempt, I used an unpruned single 1-year growth scion (lateral) over 1 m long that contained leaf buds but no flower buds or spurs. The graft piece was positioned almost horizontally on the tree and was covered with a plastic sleeve, moisturised inside, sealed at the top end, and open at the base to allow air circulation. The warming aspect of the sleeve and the length of scion used is the reason I started calling these longer scions "Long Johns."

The attached scion formed spurs with flower buds along its entire length in its first season of growth (1998–1999). During the 1999–2000 season it produced many green apples that had developed from these formed flower buds. The weight of the apples bent the branch downward and it was easy to pick from the ground and the grafted branch stayed bent in the same position even after the fruit was picked adding to the low-profile shape of the tree. This low-profile shape is also characteristic of the little or no pruning approach I have been developing (Gilbert, 2001).

I have also grafted lengthy unpruned single scions on plums, prunes, cherries and pears with great success. It is worth noting, however, that if the attached scion is pruned at the tip before or after grafting occurs, flower bud and spur formation



along its length will be compromised and results will be unsatisfactory. If the selected scion has flower buds then it is wise to remove the plastic sleeve after grafting just as the flowers start to open. This allows bees and other pollinating insects to pollinate the flowers and the scion to produce fruits during the same season as the graft was done. Integral to the success of this method is a nonpruning or very minimal pruning system of the attached scions.

Also significant to the success of grafting these very long scions, is the use of a plastic sleeve to cover the scion and graft area to prevent the scion from dehydrating and drying out. I cover the entire graft piece to below the graft area with a thin plastic sleeve open at the base and sealed at the top and moisturised with water inside the sleeve.

The plastic sleeve used is made from a section of tubular packaging plastic that is sealed at one end with masking tape. Any recycled plastic can be used to make these sleeves. Bubble-plastic can also be used as sleeve material and will enhance callus formation to a greater extent than single layer sheet plastic material. Water is squirted into the tube then the sleeve is placed over the graft piece leaving the base open for aeration. The sleeve can be pinned at the base with an ordinary sewing pin or mapping pin to prevent it blowing away. This is especially important as the longer grafts are more susceptible to damage as a result of wind movement. If the graft piece is very exposed to sunlight or high UV light then it will be necessary to either place a paper bag over the plastic sleeve or use white paint to partially paint the outside of the sleeve. This will ensure only filtered light is allowed to penetrate the sleeve, preventing sunburn.

The use of a protective sleeve has several effects upon the inserted scion. The graft piece is kept protected from the weather, the humidity prevents it from drying out and dying, and the warmth inside the sleeve enhances the ability of the graft to knit quickly (i.e., callus formation is enhanced).

### **THE ELONGATED WHIP AND TONGUE GRAFT**

To attach lengthy scions I have found that an elongated whip and tongue graft is best, providing the graft area is triple wrapped with budding tape to secure the scion at that point and prevent any movement at the graft union. The wrapping tape is left on for 9–10 months before removal to ensure that the tissue is fully healed all around the graft wound area. An elongated whip and tongue graft is created by making the sloping cuts used on the rootstock and scion about 100 mm or longer. This allows better contact with cambium layers (the cambium layer is situated just under the bark layer and is responsible for producing healing growth tissue) necessary for grafting to occur. To create the “tongue” of the whip and tongue graft a horizontal cut is made across the original sloping cuts made on the scion and rootstock and split for 10–20 mm. One horizontal cut is made half way along the original sloping cut of the rootstock or scion piece and the other cut one-third of the way along the other sloping cut so as to make sure the whip and tongue fits neatly together.

Because the scions are very long it may be an advantage to secure the scion in place or rest it on another limb or support to prevent damage from wind. If the scion is moved too much by wind the graft will not “take” and the operation will be a failure.

## CONTINUING EXPERIMENTATION

Later experiments involved the use of long scions (over 1 m) chosen from 2- to 4-year-old branches that had already formed flower buds and short flower bud spurs along their length, to ensure fruit production from the "Long John" scions during their first season of growth. Some of these grafts were made on espalier trained fruit trees.

On one espalier apple tree I tried to create instant fruiting limbs. Two selected scions over 1 m long were cut from donor trees, one an improved selection of *M. domestica* 'Golden Delicious' named *M. domestica* 'Jim Riley' and the other an old heritage cultivar named *M. domestica* 'James Grieve'. The grafting onto a *M. domestica* 'Snow Apple' tree was carried out in August. By the end of November the flower buds on the scions had started to open slightly and the sleeve was removed to allow bees to pollinate the flowers. Pollination was successful and each "Long John" scion piece produced one 10-L plastic bucket of fruit in late summer. These branches were then left unpruned and the following year (2nd), they produced another bountiful crop. In the following year (3rd) they were also left unpruned and produced another similar crop.

One advantage of placing "Long John" grafts onto an espalier tree is that you get instant limbs with spur systems already formed that are suitable for a nonpruning or very minimal pruning regime. Pruning the traditional way, it may take 3 or 4 years to train a limb or graft scion to that same length using harsh spur pruning methods.

To take the technique further, there is no reason why an aged or misshapen tree could not be cut back substantially, even to a stump, then allowed to grow 20 or 30 long thin branches. These thin regrowth branches could then be grafted onto (using "Long John" grafts) during the following winter. Each scion could be a different cultivar giving you a range of fruits maturing over a long time period or they could be all of one cultivar. Multi grafting is one way to save rare heritage cultivars and it is also a method of producing a tree with many types of fruit.

"Long John" branches can also be grafted to the cut limbs to achieve an instant fan-shaped espalier. One way of dealing with suckers growing from a tree rootstock is to graft a "Long John" scion to the sucker to utilize the rootstocks potential, and to slow tree growth and reduce further suckering from the root system.

## CONCLUSION

I believe the "Long John" grafting technique has potential for commercial use as well as for home gardeners interested in quick production from fruit trees or in multi-grafting espalier grown trees. Scions are easily collected from the many heritage cultivars still around in back gardens as I have found on Bruny Island. Scions from these can easily be added to a collection grafted onto a single tree. The "Long John" grafts can be used on potted plant specimens with ease to produce instant "formed" plants suitable for small garden areas. With stone fruits the use of a compatible rootstock will enable apricots, peaches, plums, prunes, nectarines, and almonds to be grafted to the one tree. I am continuing to work on the "Long John" grafts improving the technique and developing its potential.

## LITERATURE CITED

Gilbert, A. L. 2001. All about apples. Hyland House, Melbourne.

## Breeding with Indigenous *Citrus* Species®

S.R. Sykes

CSIRO Plant Industry, Private Mail Bag, Merbein, VIC 3505

### INTRODUCTION

Genetic variability is the foundation for breeding new cultivars. Wild relatives and undomesticated types of exploited crop plants are often extremely important sources of genetic variability and Zagaja (1983) lists examples where these have been of unquestionable value in fruit improvement.

Although the history of planned genetic improvement of cultivated citrus is short, wild types and relatives have been valuable in breeding new cultivars, particularly rootstocks. Carrizo and Troyer citranges are important rootstocks selected from a cross between *Citrus sinensis* 'Washington' × *Poncirus trifoliata*. Similarly, Swingle citrumelo, another rootstock, was selected from hybrids of *Citrus ×paradisi* (grapefruit) × *P. trifoliata*.

Australian *Citrus* species still exist in their natural habitat. This paper describes plant-breeding activities in which *Citrus* species indigenous to Australia have been used to develop unique, new cultivars.

### AUSTRALIA'S INDIGENOUS CITRUS

The genus *Citrus* was classified in the tribe *Citreae* within the sub-family *Aurantioideae* as part of the family *Rutaceae* by Swingle and Reece (1967). Swingle and Reece (1967) included five other genera, viz. *Poncirus*, *Fortunella*, *Eremocitrus*, *Microcitrus*, and *Clymenia* within the *Citreae*, which they considered as the true citrus-types. The genera names *Eremocitrus* and *Microcitrus* survived until Mabblerley (1998) argued that they should be re-classified as *Citrus*, which is now a widely held opinion and will be used in this paper. Australia is the unique home to *Citrus glauca* (syn. *Eremocitrus glauca*), desert lime or desert kumquat; *C. australasica* (syn. *Microcitrus australasica*), finger lime; *C. australis*, Australian round lime or dooja; *C. inodora*, Russell River lime; *C. maideniana*, Maiden's Australian wild lime; and *C. garrawayae*, Mount White lime (Swingle and Reece, 1967; Armstrong, 1975). Although *Citrus gracilis*, Humpty Doo lime, is also considered indigenous to Australia, *C. glauca*, *C. australasica*, and *C. australis* have been of greatest interest to citrus researchers and breeders from their potential as new rootstocks (Bitters et al., 1964) and as sources of valuable genetic characteristics (e.g., Barrett, 1990). Although first collected in 1971 by J. McKean near Humpty Doo, NT, little is known scientifically about *C. gracilis*. It is a thorny tree up to 4–6 m high and grows in eucalypt woodlands on sandy or gravelly soils (Mabblerley, 1998). Its fruits are of interest because of their large size (up to 8 cm in diameter) in comparison to other Australian *Citrus* species.

Distributed in Queensland, New South Wales, and South Australia (Sykes, 1997), *Citrus glauca* is the most pronounced xerophyte in the *Aurantioideae*. Following germination and emergence, desert lime seedlings develop extensive root systems before much shoot growth occurs allowing them to withstand severe droughts and hot dry winds. When dormant, it can survive temperatures as low as -14 °C (Young et al., 1983) and this cold hardiness is transmitted to its sexual progeny (Yelon-

sky, 1978). It is considered less susceptible to salt and boron than related genera (Swingle and Reece, 1967; Bitters et al., 1964). Goell (1969) reported that lemon scions grafted to the desert lime tolerated salinity, although they had high leaf chloride concentrations.

The desert lime can be grafted to citrus and vice versa (Bitters et al., 1964). Hearn et al. (1974) reported it highly resistant to root rot caused by *Phytophthora parasitica*. Its fruits mature quickly and drop from the tree 10–12 weeks after flowering, and Barrett (1981) reported that this characteristic was transmitted to its hybrids. Desert limes are acid yet pleasantly flavoured and, as Riley (1982) pointed out, less bitter than many acid fruits of other citrus relatives.

The seven species of *Citrus* classified by Swingle and Reece (1967) as *Microcitrus* are confined generally to rainforests in Australia and southeastern New Guinea (Armstrong, 1975). The five Australian species are distributed from Cape York in far north Queensland to coastal regions of southeastern Queensland and northern NSW. Two of the Australian species, *C. maideniana* and *C. garrawayae*, have a very narrow habitat range whereas *C. australis* and *C. australasica* are more widely distributed (Armstrong, 1975). Pigmented forms of the finger lime are found in SE Queensland. *Citrus warburgiana* (syn. *Microcitrus warburgiana*) is found in SE New Guinea (Swingle and Reece, 1967) and *C. papuana*, which is possibly a variant of *C. warburgiana*, was described by Winters (1976). *Citrus papuana* is of interest to citrus breeders due to its short juvenile period, which may be transmitted to hybrids (Barrett, 1983).

Finger and round limes graft readily with other *Citrus* types (Bitters et al., 1964) and they may be genetic sources of drought tolerance, nematode resistance, tolerance of low soil fertility, and resistance to root rot caused by *P. citrophthora* (Barrett, 1983, Broadbent, 1969, Bitters et al., 1964). The dwarf, shrubby habit of finger and round lime trees suggests they have potential as a source of dwarfing in breeding programs, while forms with red and pink fruits have attracted breeders' attention for developing new pigmented cultivars.

## NEW CITRUS CULTIVARS BASED ON AUSTRALIAN *CITRUS* SPECIES

New cultivars involving Australian *Citrus* species have arisen essentially in one of two ways, namely selection amongst specimens collected as propagules from their habitat, and selection of seedlings either from open-pollinated populations or hybrid families from controlled crosses.

**Cultivars Selected from Propagules Collected from the Wild.** Historically Australian native limes have been harvested from the wild as a food source. From this, they have been seen as candidates for domestication in their own right and cultivars have been nominated and released after selection from material collected from their habitat. For example, new cultivars of finger lime have been selected, propagated, and commercialised. *Citrus australasica* var. *sanguinea* 'Rainforest Pearl'<sup>PBR</sup> (Birmingham, 2002) is one finger lime cultivar and another group includes highly pigmented forms with names such as 'Purple Viola', 'Pink Ice', and 'Jali Red' developed by the Australian Finger Lime Company (Anon, 2005).

*Citrus glauca* 'Australian Outback'<sup>PBR</sup> (Sykes, 2002) was identified from an arboretum-based collection of desert lime variants (Sykes, 1997). Initially chosen for fruit processing qualities, 'Australian Outback' was also selected for its ease of

propagation, its high yields of larger than average fruits and because its thornless, upright habit makes it suitable as a plantation or orchard tree. It was released to the developing native foods industry to give consistent production of quality desert limes and reduce dependence on wild harvested product.

**Cultivars Selected from Hybrid Populations.** The use of native *Citrus* in breeding rootstocks and scion cultivars by hybridization has been investigated by CSIRO. Species used have been *C. glauca*, *C. australis*, *C. australasica*, and the so-called Sydney hybrid (*C. australis* × *C. australasica*), which has been given species status (*C. ×virgata*) by some authors (e.g., Hume, 1957). It was anticipated that Australian native limes would benefit rootstock breeding by conferring tolerance to cold, salt, drought, and nematodes, resistance to *Phytophthora* species, as well as dwarf-inducement, to new hybrids. In breeding scions, it was anticipated that native limes would introduce short juvenile time, fruit pigmentation and reduced maturation time, as well as cold tolerance and improved water-use efficiency based on their reported drought tolerance.

Over a period of time, crosses have been made between indigenous *Citrus* species and other *Citrus* species as well as with *Poncirus trifoliata*. In addition, open-pollinated seedlings from non-indigenous *Citrus* seed parents but with obvious *C. australis* and *C. australasica* characteristics have been retained for evaluation. CSIRO now has a collection of hybrids from first and second generation crosses with *C. glauca*, *C. australis*, and *C. australasica*. In conducting crosses, success has been greater with *C. australis* and *C. australasica*, than with *C. glauca*. Although hybrids have been obtained using the desert lime as both a male and a female parent, there have been problems growing *C. glauca* hybrids on their own roots and grafting them to rootstocks has often been necessary to maintain these hybrids beyond the young seedling stage.

In addition to generating new hybrids, CSIRO also introduced open-pollinated seeds collected from hybrids produced in the U.S.A. Open-pollinated seeds of *C. 'Faustrimedín'* [*Citrus australasica* × (*Fortunella* sp. × *Citrus reticulata* 'Calamondín')] as well as *C. 'Eremolemon'* (*Citrus glauca* × *Citrus limon* 'Meyer lemon') (see Swingle and Reece, 1967), were obtained from the University of California. Seeds of *C. glauca* hybrids were also received from the United States Department of Agriculture, Florida.

This collection of hybrid material is a genetic resource held specifically for breeding. In making crosses, a primary aim has been to use the progeny as genetic bridges between *C. glauca*, *C. australis*, and *C. australasica* on the one hand and introduced *Citrus* on the other. To facilitate this, monoembryonic parents were used to increase the chances of obtaining monoembryonic hybrids, which would in turn make them easier to use as parents for introgressing native *Citrus* characteristics into breeding populations. Until the late 1980s, this was the purpose of these crosses and introductions.

In the late 1980s and early 1990s the native food industry started to gain momentum in Australia and *Citrus* was one of the fruits in which the industry took particular interest. An approach by the industry stimulated CSIRO to look at its collection of native limes and hybrids as a resource for this industry. At the same time that the *Citrus glauca* 'Australian Outback'<sup>PBR</sup> was selected and released, *Citrus* hybrid 'Australian Blood'<sup>PBR</sup> and *Citrus* hybrid 'Australian Sunrise'<sup>PBR</sup> (Sykes, 2002) were identified from CSIRO's collection of hybrid material.

The 'Australian Blood' was selected from a progeny of open-pollinated seedlings from a zygotic seedling of *C. xlimonia*, Rangpur lime. Seedlings in this progeny displayed finger lime characteristics and, since their maternal Rangpur lime seedling parent was located next to a row of finger lime trees, it was assumed that *C. australasica* was the pollen parent of the 'Australian Blood' (Sykes, 2002). Similarly, 'Australian Sunrise' was selected from seedlings grown from open-pollinated seeds of a faustrimedii hybrid introduced from the University of California (Sykes, 2002).

## END NOTE

The use of Australia's indigenous *Citrus* species described here provides two valuable lessons. The first is that wild species of fruit crops can still be considered as candidates for domestication in their own right. The selection of new cultivars of desert and finger limes from propagules collected from the wild clearly supports this idea discussed over 20 years ago by Zagaja (1983). The second lesson highlights the need to conserve and maintain wild relatives of cultivated fruit species in arboreta. While their pedigrees show that the 'Australian Blood' and 'Australian Sunrise' cultivars are not strictly native plants, they have been used by the Australian native food industry to produce fruits for processing and fresh produce. As such, the potential of using Australia's indigenous *Citrus* in breeding novel fruit types has been demonstrated. Hybrids from second generation crosses involving indigenous *Citrus*, which produce fruits larger than the 'Australian Blood' or 'Australian Sunrise' cultivars yet incorporate similar characteristics, suggest that cultivars with greater novelty and thus ability to capture market attention are possible.

## LITERATURE CITED

- Armstrong, J.** 1975. The current status of the sub-family Aurantioideae. Australian plants—Rutaceae. 8:226–31.
- Australian Finger Lime Company.** 2005. Finger lime varieties. <<http://www.australianfingerlime.com/varieties.html>>
- Barrett, H.C.** 1981. Breeding cold-hardy citrus scion cultivars. Proc. Int. Soc. Citriculture, 1981. 1:61–6.
- Barrett, H.C.** 1983. Hybridisation of *Citrus* and related genera. Fruit Var. J. 39:11–16.
- Barrett, H.C.** 1990. An intergeneric hybrid of *Microcitrus papuana* and *Citrus medica*. Fruit Var. J. 44(3):113–7.
- Birmingham, E.** 2002. 'Rainforest Pearl'. Plant Varieties J. 15(4):33–34.
- Bitters, W.P., J.A. Brusca, and D.A. Cole.** 1964. The search for new citrus rootstocks. Calif. Citrograph 49:443–8.
- Broadbent, P.** 1969. Observations on the mode of infection of *Phytophthora citrophthora* in resistant and susceptible roots. Proc 1st. Intl. Citrus Symp. 3:1207–10.
- Goell, A.** 1969. Salinity effects on citrus trees. Proc 1st. Intl. Citrus Symp. 3:1819–24.
- Hearn, C.J., D.J. Hutchinson, and H.C. Barrett.** 1974. Breeding citrus rootstocks. Hort-Science, 9:357–8.
- Hume, H.H.** 1957. Citrus fruits. The MacMillan Co., New York.
- Mabberley, D.J.** 1998. Australian Citreae with notes on other Aurantioideae (Rutaceae). Telopea 7:333–344.
- Riley, J.M.** 1982. Wild fruits of Australia. Calif. Rare Fruit Growers Yearbook 14:68–75.
- Swingle, W.T. and Reece, P.C.** 1967. The botany of *Citrus* and its wild relatives, pp. 190–430. In: W. Reuther, H.J. Webber and L.D. Batchelor (eds.). The Citrus Industry. Vol. 1. Univ. Calif. Press, Berkeley.
- Sykes, S. R.** 1997. Australian native limes (*Eremocitrus* and *Microcitrus*); a citrus breeder's viewpoint. Austral. Bushfoods Mag. 3:12–15.
- Sykes, S.R.** 2002. 'Australian Outback', 'Australian Blood' and 'Australian Sunrise' Plant Varieties J. 15(4):18–21.

- Winters, H.F. 1976. *Microcitrus papuana*, a new species from Papua New Guinea (Rutaceae). *Baileya* 20:19–24.
- Yelonsky, G., H. Barrett, and R. Young. 1978. Cold hardiness of young hybrid trees of *Eremocitrus glauca* (Lindl.) Swing. *HortScience* 13:257–8.
- Young, R., H.C. Barrett, C.J. Hearn, and D.J. Hutchison. 1983. New sources of cold hardiness for citrus breeding. *HortScience* 17:866.
- Zagaja, S.W. 1983. Germplasm resources and exploration, pp. 3–10. In: J.N. Moore, and J. Janick (eds.). *Methods in fruit breeding*. Purdue Univ. Press, West Lafayette, Indiana.

---

## Auscitrus — The Australian Citrus Budwood Scheme®

**Tim Herrmann**

Auscitrus Manager, PO Box 269, Dareton NSW 2717

### PRESENT STRUCTURE OF AUSCITRUS

Auscitrus is the trading name of the Australian Citrus Propagation Association Incorporated (ACPA). The ACPA is comprised of ten citrus and nursery industry organisations. Representatives from each of these organisations are nominated as representatives on the Auscitrus board. Auscitrus is an industry owned and operated, not-for-profit organisation. The seed and budwood scheme is entirely self-funding through seed and budwood sales. Cultivar importation, cultivar evaluation, and the maintenance of foundation trees, are funded by industry grants through Horticulture Australia Limited.

Currently Auscitrus employ a full time manager, part time administration officer, full time scientific officer (indexing), full time casual indexing assistant, full time bud cutter, full time casual bud cutter/nursery hand, plus one or two seasonal casual staff for bud cutting and fruit harvest. New South Wales Department of Primary Industries (NSW DPI) research scientists on behalf of Auscitrus carry out horticultural evaluation.

### HISTORY OF AUSCITRUS

**1927.** Fruit Industry conference recommendation to establish a controlling body for the buying and selling of selected citrus budwood.

**1928.** Cooperative Bud Selection Society formed — startup funding from government grant of £1500. First selected trees established at Narara Research Station, Gosford.

**1938.** “Certificate from Nurseries” introduced to identify trees propagated from Bud Selection Society’s budwood.

**1941.** *Phytophthora citrophthora* discovered to be cause of extensive tree losses in Australian orchards. Demand for trees on highly resistant *Poncirus trifoliata* stock increased.

**1947.** Scaly butt (exocortis viroid) recognised as bud transmitted disease affecting *P. trifoliata*.

**1952.** Australian Citrus Improvement Association (ACIA) formed with objectives including virus screening/indexing, breeding, selection, improvement, and evaluation of rootstocks and scions.



- Winters, H.F. 1976. *Microcitrus papuana*, a new species from Papua New Guinea (Rutaceae). *Baileya* 20:19–24.
- Yelonsky, G., H. Barrett, and R. Young. 1978. Cold hardiness of young hybrid trees of *Eremocitrus glauca* (Lindl.) Swing. *HortScience* 13:257–8.
- Young, R., H.C. Barrett, C.J. Hearn, and D.J. Hutchison. 1983. New sources of cold hardiness for citrus breeding. *HortScience* 17:866.
- Zagaja, S.W. 1983. Germplasm resources and exploration, pp. 3–10. In: J.N. Moore, and J. Janick (eds.). *Methods in fruit breeding*. Purdue Univ. Press, West Lafayette, Indiana.

---

## Auscitrus — The Australian Citrus Budwood Scheme®

Tim Herrmann

Auscitrus Manager, PO Box 269, Dareton NSW 2717

### PRESENT STRUCTURE OF AUSCITRUS

Auscitrus is the trading name of the Australian Citrus Propagation Association Incorporated (ACPA). The ACPA is comprised of ten citrus and nursery industry organisations. Representatives from each of these organisations are nominated as representatives on the Auscitrus board. Auscitrus is an industry owned and operated, not-for-profit organisation. The seed and budwood scheme is entirely self-funding through seed and budwood sales. Cultivar importation, cultivar evaluation, and the maintenance of foundation trees, are funded by industry grants through Horticulture Australia Limited.

Currently Auscitrus employ a full time manager, part time administration officer, full time scientific officer (indexing), full time casual indexing assistant, full time bud cutter, full time casual bud cutter/nursery hand, plus one or two seasonal casual staff for bud cutting and fruit harvest. New South Wales Department of Primary Industries (NSW DPI) research scientists on behalf of Auscitrus carry out horticultural evaluation.

### HISTORY OF AUSCITRUS

**1927.** Fruit Industry conference recommendation to establish a controlling body for the buying and selling of selected citrus budwood.

**1928.** Cooperative Bud Selection Society formed — startup funding from government grant of £1500. First selected trees established at Narara Research Station, Gosford.

**1938.** “Certificate from Nurseries” introduced to identify trees propagated from Bud Selection Society’s budwood.

**1941.** *Phytophthora citrophthora* discovered to be cause of extensive tree losses in Australian orchards. Demand for trees on highly resistant *Poncirus trifoliata* stock increased.

**1947.** Scaly butt (exocortis viroid) recognised as bud transmitted disease affecting *P. trifoliata*.

**1952.** Australian Citrus Improvement Association (ACIA) formed with objectives including virus screening/indexing, breeding, selection, improvement, and evaluation of rootstocks and scions.

**1967.** Dareton selected as the site for budwood multiplication plantings, managed by NSW Department of Agriculture specifically for budwood production.

**1969.** Horticultural Stock and Nurseries Act (HSNA) passed.

**1974.** HSNA came into effect by Proclamation — all trees sold must bear a label to specify: name and address, and registered number of nursery, kind and cultivar of scion, kind of rootstock (if applicable), and either the declaration “Propagated from approved material obtained from the NSW horticultural propagation co-operative society limited”, or “Not propagated from approved material.”

**1990s.** South Australian (SA) (est. 1950s) and Queensland (est. 1931) schemes ceased supplying budwood. Queensland due to presence of severe stem pitting strains of Tristeza virus in the region, and SA due to limited indexing capacity (SA scheme now operates in association with Auscitrus, providing a supplementary supply of seed and budwood, indexed for disease by Auscitrus). Australian Citrus Propagation Association scheme now the main supplier of budwood to all Australian states.

**1993.** Australian Citrus Propagation Association Inc. (ACP) formed.

**2000.** Horticultural Stock and Nurseries Act abolished — industry unregulated from this point on.

**2001.** ACP merged with ACIA, began trading as Auscitrus.

## **CITRUS SEED/BUDWOOD PRODUCTION**

The majority of plantings are on the NSW DPI Research Station at Dareton NSW (2075 budwood trees of 108 cultivars, 664 seed trees of 32 cultivars). Current budwood sales are around 700,000–800,000 buds per year, seed around 600–700 kg (around 3 million seeds).

Auscitrus operates under deed of license with NSW DPI for seed/budwood production at Dareton, Griffith, Gosford, and for disease testing at Camden.

NSW DPI staff performs general operations such as irrigation, fertigation, and weed and pest control in budwood and seed blocks, under direction of the Auscitrus manager.

Auscitrus source quantities of seed from plantings at Gosford NSW and Monash, SA, and budwood from Monash, SA and Griffith, NSW.

A rapid multiplication polyhouse at Dareton is used to grow budwood of newly released cultivars while field budwood trees become established. All budwood is cut to order, trimmed of leaves in the field, sealed in plastic bags, and placed in a cool room to remove field heat, and for short-term (few days at most) storage.

The majority of seed and budwood is distributed via Australia Post. Budwood is packed into foam boxes with an ice container, packaged in cardboard, and sent around Australia. Three days is usually the maximum time in transit, most areas are 2 days, and some customers receive their budwood the next day.

## **DISEASE TESTING**

All disease testing is carried out at Elizabeth Macarthur Agricultural Institute (EMAI), NSW DPI, in Camden, NSW. Budwood trees are indexed every 2 years on Etrog citron indicator plants for citrus exocortis viroid (CEV) and for milder viroids (CVd I-IV) that may cause dwarfing. Trees showing suspect symptoms are further

tested for pathogens using sequential polyacrylamide gel electrophoresis (sPage) laboratory tests to determine which viroids are present. All budwood trees are indexed once every 6 years on sweet orange seedlings for orange stem pitting strains of citrus tristeza virus (CTV) and for psorosis virus. Grapefruit trees are particularly susceptible to stem pitting strains of CTV, and so are indexed annually to determine the severity of the CTV strains present. Seed trees are indexed every 6 years for psorosis virus. Other significant citrus diseases found in Australia are not seed transmitted.

Shoot-tip grafting *in vitro* is used to remove viruses and viroids from infected plants when necessary. This involves excising a 0.15-mm shoot tip from the infected plant (which hopefully does not carry the virus), and grafting onto a 2-week-old rough lemon seedling growing in sterile agar medium in a test tube. If successful, the resulting grafted seedling is grown on and indexed to confirm the virus/viroid has been removed.

Two trees of each cultivar are held in an insect-proof screenhouse at EMAI, Camden, as foundation virus free (FVF) trees. Many varieties also have two trees each pre-immunised with a protective strain of citrus tristeza virus (CTV PB61), which protects against severe stem pitting strains of CTV as found in Queensland. All trees propagated for budwood supply are propagated from budwood from these trees.

### **BENEFITS OF AUSCITRUS SCHEME TO INDUSTRY**

The scheme provides a readily available source of citrus seed and budwood of highest possible health status from trees routinely checked for trueness-to-type and grown specifically for budwood production. High health status maintains productivity of orchards and therefore improves competitiveness in export markets and viability in domestic markets.

The scheme ensures trueness-to-type of orchards and therefore consistency of product, which flows on to consumer confidence in product. It is also a part of a larger strategy to maintain access to markets with strict quarantine regulations, e.g., budwood or seed movement can spread citrus canker. The scheme also provides access to budwood of newly developed or imported cultivars, enabling access to potential export markets.

### **WHY DO OUR CUSTOMERS USE THE SCHEME?**

#### **Growers.**

- Major rootstocks/cultivars grown are intolerant of graft transmissible diseases found in growing regions, and infection has serious effect on yields.
- Long-running education campaign (spanning decades) to stress importance of using clean propagation material from the citrus budwood scheme.
- Most growers respect the risks involved in planting infected trees in an orchard.
- As establishing an orchard involves a large investment, growers appreciate the security in using a known source of propagation material, tested for trueness-to-type and of the best available clonal material for each cultivar.
- Many of the better nurseries promote the use of Auscitrus material to growers.

### Nurseries.

- Understanding of the implications of introducing a graft-transmissible disease into the nursery.
- Customer demand for trees propagated from healthy, tested material.
- Confidence in quality of material grown specifically for propagation (not harvested from orchards).
- Pride in quality of trees produced.
- Convenience of having seed/budwood arrive ready to use.
- Sometimes no other source of material available.

### IMPEDIMENTS TO SUCCESS OF SCHEME

- Perception that there is no advantage in using virus-tested propagules, due to lack of education on the subject or ignorance.
- Perception that quality of budwood is not as good as budwood cut by the nursery (not necessarily justified).
- Lack of recognition of the value of budwood.
- Long lead-time (5–6 years) from release of cultivar to production of commercial quantities of budwood, encourages nurseries to rapidly multiply their own budwood.

### MAJOR RISKS TO SCHEMES LONG-TERM OPERATION

The scheme is dependant on a handful of individuals and their specialist skills could be difficult to replace. Similarly a breakdown in scientific support could lead to loss of credibility and reduced confidence in health status of propagules.

Any serious disease outbreak in parent trees could devastate the scheme.

The cost of propagules may turn nurseries away from using scheme, which is a compounding problem (i.e., reduced sales, therefore need to increase price to recover fixed costs, which leads to reduced sales again). Finally, there is a certain supply point where scheme becomes economically unsustainable.

### FUTURE OF AUSCITRUS

Increases in the costs of running the scheme on Government land will affect the viability of the seed and budwood operation, so our aim is to move the production components onto Auscitrus-owned land. We will maintain links with DPI for cultivar evaluation and scientific support in order to retain scientific base to the scheme.

We recently acquired a parcel of land, which will be privately owned by Auscitrus on behalf of the citrus industry. Operations will start moving to the new block in 2005. Our aim is to start planting new seed and budwood trees in Spring 2006. The new seed and budwood block should be fully operational and producing 100% of the industries requirements within 10 years.

**Accreditation of Citrus Nurseries.** Auscitrus is working on bringing in a formally audited citrus nursery accreditation scheme, so that nurseries who comply with the requirements of accreditation (and are audited for compliance) can promote their planting material as coming from an accredited source.

**Accreditation of Schemes Operations.** A formal quality assurance scheme is being put in place to ensure continuity of the operation should key personnel leave.

## POINTS TO CONSIDER WHEN SETTING UP A PROPAGULE SCHEME

Firstly the goals of the scheme must be identified, e.g., disease freedom (or known status), selection of best-performing clonal lines, trueness-to-type, production and distribution of propagules, or all of the above.

There must be enough usage of the scheme over a long period to make it financially viable. Low usage will result in high cost per propagule to recover costs, which will further reduce usage. There must also be a significant advantage to the general industry in using the scheme, otherwise it will be underutilized and may fail.

If health status is an important feature of the scheme, sound scientific support is required to identify the respective diseases, to determine suitable testing regimes, and to carry out the testing. This needs regular review and assessment, preferably by independent peers in the scientific community.

There may be a large capital requirement to set up the scheme — industry funding or grants may be required. People will also need to be recruited to run the scheme — finding the right person, who has the industry's well-being at heart, can be difficult. Strategies need to be put in place to allow for key staff to be replaced without jeopardizing the schemes operations.

Accreditation of nurseries can be a significant aid in increasing usage of the scheme, however this can be a complex and controversial system to implement.

The scheme must have the support of the major industry bodies, and preferably advisory services such as Department of Primary Industries, etc.

---

## Some Problems in Water Recycling<sup>©</sup>

### Stan Leach

Alstonville Palms, Ellis Road, Alstonville NSW 2477

Strict water regulation by the Council of Australia Governments is imminent. Tight controls in water use will make us all more frugal with Australia's limited water resources — having to make do with a lot less. We will be forced to conserve water and use it without degrading the environment. The government plans to return rivers to their original flows.

At Alstonville we are blessed with an average annual rainfall of 1600 mm, mainly falling in the first half of the year. The creek flowing through the property is unreliable and the underground water supply also proved unreliable. Water recycling was the answer. It seemed to be very expensive at the time but should give us dividends in the future. Our system has minimal effect on the environment and gives us a secure water supply.

Ten years of water recycling has revealed a range of challenging problems. We chose a 12.5-ha site for our nursery. The production area is located on a gentle slope all running down to a catchment dam. We received considerable assistance from N.S.W. Agriculture in the design of our system (Fig. 1).

All production areas were leveled and graded to a 1–80 fall. Drains were formed with 200- $\mu$ m plastic with agricultural pipe laid in drains, 7-mm blue metal was laid around the pipe. A 75-mm depth of 20-mm blue metal was then laid on plastic covered by weedmat. All areas were piped away commencing with 150-mm PVC underground in low volume areas, with the size increasing as volume increased to 225 mm into catchment dam. All drainage is in straight lines, with storm water pits

## POINTS TO CONSIDER WHEN SETTING UP A PROPAGULE SCHEME

Firstly the goals of the scheme must be identified, e.g., disease freedom (or known status), selection of best-performing clonal lines, trueness-to-type, production and distribution of propagules, or all of the above.

There must be enough usage of the scheme over a long period to make it financially viable. Low usage will result in high cost per propagule to recover costs, which will further reduce usage. There must also be a significant advantage to the general industry in using the scheme, otherwise it will be underutilized and may fail.

If health status is an important feature of the scheme, sound scientific support is required to identify the respective diseases, to determine suitable testing regimes, and to carry out the testing. This needs regular review and assessment, preferably by independent peers in the scientific community.

There may be a large capital requirement to set up the scheme — industry funding or grants may be required. People will also need to be recruited to run the scheme — finding the right person, who has the industry's well-being at heart, can be difficult. Strategies need to be put in place to allow for key staff to be replaced without jeopardizing the schemes operations.

Accreditation of nurseries can be a significant aid in increasing usage of the scheme, however this can be a complex and controversial system to implement.

The scheme must have the support of the major industry bodies, and preferably advisory services such as Department of Primary Industries, etc.

---

## Some Problems in Water Recycling<sup>©</sup>

### Stan Leach

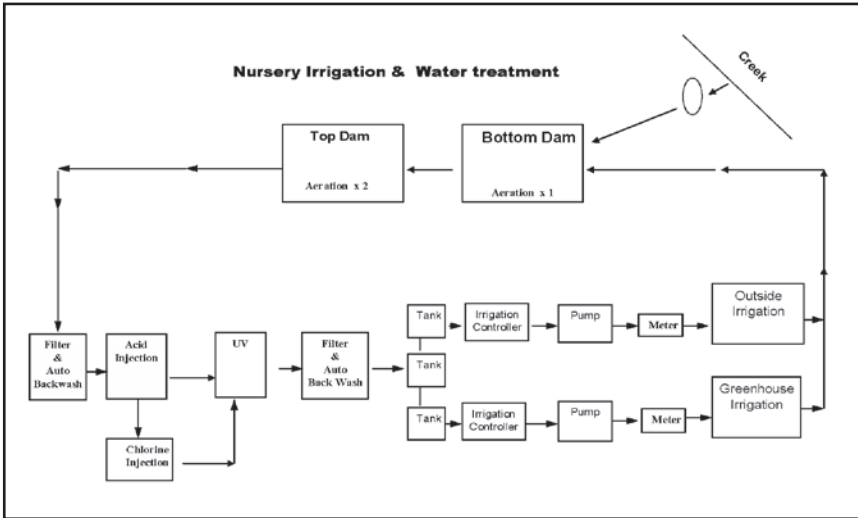
Alstonville Palms, Ellis Road, Alstonville NSW 2477

Strict water regulation by the Council of Australia Governments is imminent. Tight controls in water use will make us all more frugal with Australia's limited water resources — having to make do with a lot less. We will be forced to conserve water and use it without degrading the environment. The government plans to return rivers to their original flows.

At Alstonville we are blessed with an average annual rainfall of 1600 mm, mainly falling in the first half of the year. The creek flowing through the property is unreliable and the underground water supply also proved unreliable. Water recycling was the answer. It seemed to be very expensive at the time but should give us dividends in the future. Our system has minimal effect on the environment and gives us a secure water supply.

Ten years of water recycling has revealed a range of challenging problems. We chose a 12.5-ha site for our nursery. The production area is located on a gentle slope all running down to a catchment dam. We received considerable assistance from N.S.W. Agriculture in the design of our system (Fig. 1).

All production areas were leveled and graded to a 1–80 fall. Drains were formed with 200- $\mu$ m plastic with agricultural pipe laid in drains, 7-mm blue metal was laid around the pipe. A 75-mm depth of 20-mm blue metal was then laid on plastic covered by weedmat. All areas were piped away commencing with 150-mm PVC underground in low volume areas, with the size increasing as volume increased to 225 mm into catchment dam. All drainage is in straight lines, with storm water pits



**Figure 1.** Schematic design of water recycling system at Alstonville Palms.

installed for change of direction and future expansion and maintenance.

Both dams are lined. One dam has 500- $\mu\text{m}$  plastic and the other has polyweave. The lining is essential as the red basalt soil of Alstonville is extremely porous. This lining gives us the added benefit of no soil in the water and therefore a clean water supply to the nursery.

Apart from high rainfall adding to the system, water is reused many times. A total two-dam capacity of 17 megalitres (ML) allowed better water treatment options.

Last year (2004) our nursery used a total of 9 ML. Evaporation from dam capacity accounted for 30%–40%. Four to five megalitres of water was pumped from the creek.

Efficiency of use was paramount and we were fortunate in 1995 that our nursery was selected for a Horticulture Australia Limited research project (NY95025) looking at minimizing water use and nutrient runoff (Huett, 1999).

Considerable improvement in irrigation techniques and the addition of wind-breaks have helped. The greatest single factor in achieving water saving was the use of an International Class “A Pan.” An evaporation reading is taken on a daily basis to establish water requirements to which crop factors were added, i.e., a calculation of irrigation water to be applied based on the requirements of individual plants and prevailing environmental conditions.

Our biggest problem was algal blooms. A chelated copper product was sprayed on the surface of the dam, which killed the algae and solved the problem in the short term. Algae create high pH levels. This can produce difficulties in some forms of disinfestations, e.g., chlorine injection (which is the most popular form of disinfestation). In soilless potting media we should aim for pH values in the range of 5.5–6.3 (depending on individual plant requirements). If continually irrigating with water at a high pH level, the pH in media will also drift upwards. High pH water is also likely to clog the irrigation system by depositing calcium on irrigation equipment.

Our next major problem was a build up of broken down organic matter in the catchment dam. After 3 years we had 1.2 m of organic residue on the bottom. Or-



ganic particles of potting mix breakdown in the layer of blue metal under plants to a very fine size. Silt traps were considered expensive and too labour intensive to maintain. Therefore this technology was not implemented. We were worried that the dam would become full in the years to come.

Around March and September each year the dam was inverted bringing up lots of sediment. This added to the algal bloom problem making filtration very difficult. Investigations of this silt showed an anaerobic condition — evident by foul-smelling sulfur. Anaerobic conditions were very bad when dam water levels were low and could prove unsatisfactory for plant growth with low levels of oxygen.

**The Answer.** Aeration equipment was then installed and concentrates of microbes were added to the water. These concentrates contain billions of microbes. The aeration equipment brought all organic residues to the surface. The microbes consumed the entire residue in 8 weeks. This treatment was also of assistance in minimizing algal blooms and assisting these friendly microorganisms to stay healthy and breed. I have since established that with sufficient aeration, each of our units produces 3.3 kg of oxygen per hour so in our case two aerators were required; algae is now almost completely eliminated. Now pH levels close to neutral are easily achieved and only a small correction is required. We still correct pH to 6–6.5. We can save money because very little hydrochloric acid is needed. Aeration eliminates layering, stirring up the strata and maintaining a more consistent quality. Aeration need not be a 24-h per day exercise and should take place preferably at night.

We have since dispensed with chlorination and changed to ultra violet (UV) treatment for disinfection, with great cost savings. Cost to install and maintain UV treatment would be comparable with slow sand filtration.

Some recent research in the U.S.A. indicates that anaerobic conditions of some recycled water can be detrimental to plant growth due to low levels of dissolved oxygen. The method of irrigation application and air filled porosity of potting mixes all play a part in plant health and growth. My latest indications are that with the assistance of aeration and microbes we can emulate nature to achieve the equivalent of rainwater.

### **ADDITIONAL BENEFITS OF RECYCLING**

**Environmental.** A very important environmental point — our system utilizes only 12% of rainfall as our production areas cover 12% of land and our nursery now has a known water source that is excluded from all water charges within the Water Act 2000.

**Improved Profitability.** Our recycling system necessitated efficiency of water use, which in turn led to improved plant health and savings in production costs, i.e., fertilizer, pesticides, labour, etc.

**Self-sufficient.** Information gathered indicates that a containerized production nursery with 1400 mm of rainfall per year or even lower could be self sufficient for water providing all aspects of recycling are carried out, and dams are covered with an evaporation barrier.

### **SUMMARY**

Although recycling involves establishment costs, monitoring of oxygen and pH, careful disinfection, etc., which is more work, the benefits gained from the effort far out-weigh any costs or inconvenience incurred in the setup process.

Once the system has been established the additional upkeep is non-existent or negligible.

The Council of Australia Governments has stated for many years that water from the environment will be given to the most profitable use. Top nurseries are reporting \$60,000 gross sales per megalitres of water. However, when a nursery recycles water and procures only 2 ML of water from outside, the payback on the water can easily be as high as \$250,000 per megalitres.

### LITERATURE CITED

Huett, D.O. 1999. Improved irrigation and fertiliser management strategies for containerised nursery plants through commercial demonstrations and further research. Final Report NY95025. Horticulture Australia Limited.

---

## Water Saving, More Than Just Recycling®

### Garry Heyne

Heyne's Wholesale Nursery, Lot 5 Bolivar Rd, Burton, SA 5110

### ACKNOWLEDGEMENT

I will begin by acknowledging Lance Gladigau of Irritech. He infected in me enough of his passion for water conservation to encourage me after his death to continue his work. The result of which has been several Awards in Environmental Excellence for our wholesale nursery.

### INTRODUCTION

Heyne's Nurseries Pty Ltd is the oldest registered nursery in Australia. It was first established in Norwood, an Eastern Suburb of Adelaide, South Australia (SA), in 1869 and has played a prominent role in the development of the SA's nursery industry. High quality stock and good customer service have been our company's main aims since its beginning. The challenge of the 1990s was to produce this high quality stock economically, with minimal impact on the environment. In doing so the company aimed to increase water usage efficiency and to investigate the feasibility of recycling its runoff water. In 1995 our company received an \$11,800 grant from the Cleaner Industries Demonstration Scheme to supplement its research.

This paper will provide information on the system of recycling water from the wetlands that Heyne's Wholesale Nursery has set up in conjunction with Salisbury Council. But more importantly, it will supply information on some of the in-house procedures taken to improve water-use efficiency and decrease pollutants.

### HISTORY

In 1845 Ernest Bernhard Heyne migrated from Germany. He was a learned man with degrees, including a Diploma in Botany from Leipzig University. These, his experience gained as an employee of Dresden Botanical Gardens along with his ability to write five languages and speak seven, soon landed him the job as head draughtsman at the Royal Botanic Gardens Melbourne and Personal Secretary to Von Mueller, the director. In 1869 after trying several other ventures E.B. Heyne moved to Adelaide where he established a nursery in Bond Street, Norwood, and a

Once the system has been established the additional upkeep is non-existent or negligible.

The Council of Australia Governments has stated for many years that water from the environment will be given to the most profitable use. Top nurseries are reporting \$60,000 gross sales per megalitres of water. However, when a nursery recycles water and procures only 2 ML of water from outside, the payback on the water can easily be as high as \$250,000 per megalitres.

### LITERATURE CITED

Huett, D.O. 1999. Improved irrigation and fertiliser management strategies for containerised nursery plants through commercial demonstrations and further research. Final Report NY95025. Horticulture Australia Limited.

---

## Water Saving, More Than Just Recycling®

### Garry Heyne

Heyne's Wholesale Nursery, Lot 5 Bolivar Rd, Burton, SA 5110

### ACKNOWLEDGEMENT

I will begin by acknowledging Lance Gladigau of Irritech. He infected in me enough of his passion for water conservation to encourage me after his death to continue his work. The result of which has been several Awards in Environmental Excellence for our wholesale nursery.

### INTRODUCTION

Heyne's Nurseries Pty Ltd is the oldest registered nursery in Australia. It was first established in Norwood, an Eastern Suburb of Adelaide, South Australia (SA), in 1869 and has played a prominent role in the development of the SA's nursery industry. High quality stock and good customer service have been our company's main aims since its beginning. The challenge of the 1990s was to produce this high quality stock economically, with minimal impact on the environment. In doing so the company aimed to increase water usage efficiency and to investigate the feasibility of recycling its runoff water. In 1995 our company received an \$11,800 grant from the Cleaner Industries Demonstration Scheme to supplement its research.

This paper will provide information on the system of recycling water from the wetlands that Heyne's Wholesale Nursery has set up in conjunction with Salisbury Council. But more importantly, it will supply information on some of the in-house procedures taken to improve water-use efficiency and decrease pollutants.

### HISTORY

In 1845 Ernest Bernhard Heyne migrated from Germany. He was a learned man with degrees, including a Diploma in Botany from Leipzig University. These, his experience gained as an employee of Dresden Botanical Gardens along with his ability to write five languages and speak seven, soon landed him the job as head draughtsman at the Royal Botanic Gardens Melbourne and Personal Secretary to Von Mueller, the director. In 1869 after trying several other ventures E.B. Heyne moved to Adelaide where he established a nursery in Bond Street, Norwood, and a



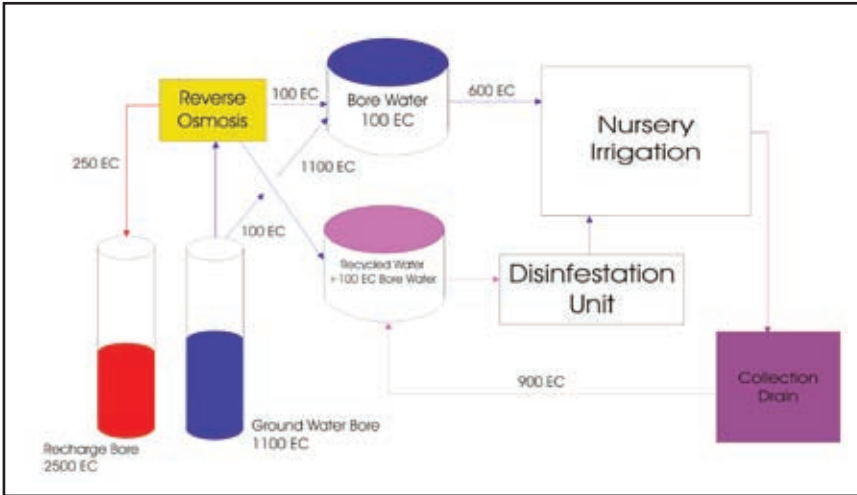
**Figure 1.** An extensive system of windbreaks had to be erected at the wholesale site.

shop in Rundle Street, Adelaide. After his death his wife continued to operate the business until their son Carl F. Heyne graduated from Roseworthy College. In 1924 Carl F. established a nursery/retail outlet on land he had purchased on the Parade at Beulah Park. His son Franz W. Heyne (Wally) joined him in, and continued to expand, the garden centre on that same site. Sons Roger and Garry Heyne became the fourth generation to become involved in the nursery and in 1984 a 9.4-ha section of land was purchased north of Adelaide (wheat country) at the intersection of Bolivar and Waterloo Corner Roads, Burton. Garry Heyne established a wholesale production nursery on this site. Both of his sons, Carl and Adam, work with him and Roger's son, Michael, works at the Garden Centre.

### **HEYNE'S WHOLESALE NURSERY**

**Customer Base.** The Wholesale Nursery supplies both retailers and the landscaping industry, the latter requiring a large range of species and container sizes in and out of season. This has made irrigation more difficult and has resulted in much in house research into improving irrigation practices.

**Environment.** The site was flat and unprotected, so a 3-m-wide windbreak of native dry-land trees were planted around the initial 4 ha to minimize wind damage



**Figure 2.** Flow diagram of alternative irrigation system.

and to reduce water loss from excessive transpiration and evaporation from the potting soil and gravel. A network of 2.7-m-high windbreaks covered in 50% mesh has also been erected to increase the wind protection within the nursery (Fig. 1).

**Possible In-House Recycling.** When the nursery was established, large amounts of clay filling were transported in to allow all the runoff water to be directed to one particular point with a view to recycling. Some areas were raised by up to 1.5 m. Lance and I first looked at recycling the runoff water in 1994 but due to the salinity of the mains supply the runoff water reached unacceptable salinity levels (Dec. 1994 — electrical conductivity (EC)  $1340 \mu\text{S}\cdot\text{cm}^{-1}$ ). Reverse osmosis (RO) of the water was not viable because of the suspended fine particles (20-micron filtration allowed 40% UV penetration). It was decided to look at the feasibility of RO treatment of bore water (EC  $1100 \mu\text{S}\cdot\text{cm}^{-1}$ ) and use the EC  $100 \mu\text{S}\cdot\text{cm}^{-1}$  portion produced to dilute the runoff water (the uncontaminated remaining bore water to be placed in a more saline aquifer). The usable water would then possibly be disinfected with chlorine dioxide (Fig. 2).

### SUPPLY FROM KAURNA PARK WETLANDS

In 1995 discussions were held with Salisbury Council with a view to being supplied with winter stormwater from Kaurna Park Wetlands. This was to be the first commercial use of water from the vast network of Salisbury Council planned wetlands.

#### Water Collected at Kaurna Park Wetlands.

**Quality.** Electric conductivity approx  $260 \mu\text{S}\cdot\text{cm}^{-1}$ , pH 7.4–7.8, the water has a very low level of contaminants and undesirable pathogens (the principle of wetlands disinfection is similar to that of slow sand disinfection). The Salisbury Council uses aquifer recharge water for sprinkler irrigation of parks without treatment or signage.

**Storage.** The water is gravity fed via a bore into the T2 aquifer. When this becomes impractical due to pressure build up in the filling aquifer, the recharging is

enhanced with a pump ( $40 \text{ L}\cdot\text{s}^{-1}$ ). The sandy nature of the aquifer allows injected water to displace the original bore water (high EC) in an orderly fashion forming a fresh water "bubble" allowing approximately 80% to be retrieved without saline contamination. Water is retrieved on demand and pumped at  $12 \text{ L}\cdot\text{s}^{-1}$  to the nursery site, treated, and stored in  $3 \times 160,000 \text{ L}$  tanks.

**Treatment.** Sulfuric acid (67%) is injected into the water, changing the pH to approximately 6.5. This assists plant growth and keeps the calcium bicarbonate from precipitating and blocking drippers. The result is a max EC of  $330 \mu\text{S}\cdot\text{cm}^{-1}$ . The water is filtered by two sand filters and then passes through an ultraviolet disinfection system before entering the storage tanks. Turbidity, pH, EC, and UV are monitored constantly. Any failures will shut supply down and solenoids then fill tanks from two 50-mm potable mains water meters.

**Use.** The water is distributed through two variable speed pumps. One supplies the sprinkler system running sections of Antelco Roto Rains® at 150 Kpa and the other supplies a vast system of Antelco® drippers and shrubblers at 110 Kpa.

**Savings.** In the last financial year, the nursery used 124,000 kL of water at a cost of \$45,000 including pumping and associated chemicals. The same amount purchased from the South Australian water authority would cost about \$125,000.

#### Comments on the System.

- A UV disinfection treatment was chosen because the turbidity of my water was suitable, it was economical to run, proven, and with the right equipment safe and simple to maintain.
- In the near future the old float switches will be replaced with a pressure transducer, as it is more reliable and easier to access information via a computer.
- Because the UV has no residual effect, the tanks and irrigation lines are periodically treated with a disinfectant.
- Not realising at the planning stage how much the pH of recharged aquifers would vary, a fixed rate, manually adjustable acid-injection unit was installed. This will be replaced with a self-monitoring variable injection system.

**Water Saving and Chemical Reduction.** Recently, we have investigated the possibility of recycling our runoff water. As a result of the cost and the need to use disinfectants, we have decided to continue to allow the water to run back into the wetlands, where the treatment is far more environmentally acceptable. Regardless of where this runoff ends up, it is essential that it have minimal contaminants. Irrigation efficiency is a major part of this, as excessive wetting of the foliage causes an increase in pesticide use, and leaching of the potting mix has a direct effect on the amount of these contaminants. (NB: There are frogs and yabbies in our nursery drains and the ducks in the wetlands where we deposit our runoff water are as happy as the ones at Kaurna Park where we source our water.)

#### DRIP IRRIGATION

The majority of the 20-cm containers and all larger containers are watered by drip irrigation. We will be installing more drip irrigation and will be looking seriously at capillary for the smaller pots. In our nursery, cells of fresh potted 20-cm pots

are irrigated in the same cycle as the more established plants adjacent to them. We found that the water drained through the fresh potting mix quickly without reaching the sides. We did not want to alter the mix, as the older plants were fine. We assumed that in time, with compaction, composting, and the extra root growth in the mix, these pots would behave the same as the older. We set up a trial. Two trolleys were set up to be watered by drip and have the ability to collect any drained water individually from each plant for measuring. Trolleys were used so that the trial could be moved to avoid rain. One of the trolleys was pulse watered. Wetting agents were added to the surface of selected pots. Results showed that pulse watering had some benefits, wetting agent added to the surface had the most effect, and the combination of the two was the best. Further testing allowed us to determine the optimal amount of applied water. The juvenile plants could then be made to fit with the watering cycle of the nursery.

### **AQUAMISER®**

A persistent Lance Gladigau kept coming up with ideas that intrigued me. He was determined that the need to irrigate a nursery was directly proportional to the evaporation rate from a container. We installed a “V” notch weir on our runoff drain and connected it to a chart recorder. The volume of water over the weir was constantly recorded. We were able to plot the volume of water retained in the nursery (mains water — runoff water) on a graph. Concurrently we were able to record water transpiration from a class A pan on a graph. The two graphs were virtually identical. We have installed Aquamisers® to control irrigation in the nursery. We are about to install them on beds containing low-water-use plants and will adjust them to higher evaporation rates before operating.

### **SPRINKLER DISTRIBUTION**

An in-field catch test was conducted on the original sprinklers and on Antelco Roto Rains®. It was found that the uniformity of distribution (coefficient of uniformity) could be increased from 67% to 87% by changing sprinkler heads.

### **SPRINKLER CONTROLLERS**

Irrigation is controlled by 32-station Micro Master® controllers. To allow staff to irrigate individual areas without running the complete cycle, and without wetting clients, manual electric control boxes have been installed at visual vantage points throughout the nursery. Percentage run times of the controllers are monitored and altered according to the season. Manual input controls are also installed allowing nonmanagement staff to irrigate according to conditions. Simplicity of operation is the philosophy used throughout the nursery, to minimize operational errors and water wastage.

### **CHEMICAL CONTROL**

**Weed Control.** We use glyphosate on weeds that “get away,” Rout™ as a pre-emergent on most containers, and Sierra Ron™ as a pre-emergent on all growing surfaces. Used correctly it has little effect on the environment. In fact, since we have virtually eliminated weeds, we spray our deciduous plants less often as the breeding grounds for white fly in early spring have been eliminated.



**Insect Control.** We have always had a policy of using the safest possible spray that will do the job reasonably well. We now use a Hardi MRY® knapsack mist blower instead of a conventional tank, pump, and boom. We can spray the same area with 1/6 of the volume of spray. That is an 82% reduction.

## SUMMARY

As a result of the above measures, the installation of a variable speed pump, and diligence, Heyne's Wholesale Nursery has been able to reduce the amount of irrigation water used (Table 1).

**Table 1.** Water use at Heyne's Wholesale Nursery.

Year	Water used (kL)	Saving since 1993/94
1993/94	89,500	
1994/95	81,000	9%
1995/96	64,000	21%

Our situation is unique, because of the adjacent wetlands, however on my recent trip to Fremantle (Western Australia) to the National Nursery & Garden Industry Association (NGIA) Conference, the amount of water recycling technology and the amount of assistance available now amazed me. NGIA development officers are available in every state. The technology is there for all to improve our irrigation techniques now and into the future.

## Evaluating an Irrigation System Upgrade®

**John Messina**

Sunraysia Nurseries, PO Box 45, Gol Gol NSW 2738

### INTRODUCTION

As part of a major irrigation system upgrade, Sunraysia Nurseries conducted a test of system efficiency under the Nursery and Garden Industry of Australia (NGIA) "Waterworks" program.

The program consisted of training in assessing existing system output and efficiency, and recommendations for improvements. There were two major areas that were examined:

- An existing shadehouse with overhead "B500" sprinklers on a 4.0 m × 4.5 m spacing.
- An existing group of polyhouses with overhead "Eindor" sprinklers on a 2.0 m × 3.2 m spacing.

### METHOD

Catch cans were placed in a grid across the growing areas. Irrigation was allowed to run and the amount of water in each can was measured and analyzed using the Waterwork calculator supplied as part of the training package.

**Insect Control.** We have always had a policy of using the safest possible spray that will do the job reasonably well. We now use a Hardi MRY® knapsack mist blower instead of a conventional tank, pump, and boom. We can spray the same area with 1/6 of the volume of spray. That is an 82% reduction.

## SUMMARY

As a result of the above measures, the installation of a variable speed pump, and diligence, Heyne's Wholesale Nursery has been able to reduce the amount of irrigation water used (Table 1).

**Table 1.** Water use at Heyne's Wholesale Nursery.

Year	Water used (kL)	Saving since 1993/94
1993/94	89,500	
1994/95	81,000	9%
1995/96	64,000	21%

Our situation is unique, because of the adjacent wetlands, however on my recent trip to Fremantle (Western Australia) to the National Nursery & Garden Industry Association (NGIA) Conference, the amount of water recycling technology and the amount of assistance available now amazed me. NGIA development officers are available in every state. The technology is there for all to improve our irrigation techniques now and into the future.

## Evaluating an Irrigation System Upgrade®

**John Messina**

Sunraysia Nurseries, PO Box 45, Gol Gol NSW 2738

### INTRODUCTION

As part of a major irrigation system upgrade, Sunraysia Nurseries conducted a test of system efficiency under the Nursery and Garden Industry of Australia (NGIA) "Waterworks" program.

The program consisted of training in assessing existing system output and efficiency, and recommendations for improvements. There were two major areas that were examined:

- An existing shadehouse with overhead "B500" sprinklers on a 4.0 m × 4.5 m spacing.
- An existing group of polyhouses with overhead "Eindor" sprinklers on a 2.0 m × 3.2 m spacing.

### METHOD

Catch cans were placed in a grid across the growing areas. Irrigation was allowed to run and the amount of water in each can was measured and analyzed using the Waterwork calculator supplied as part of the training package.

## RESULTS

The results of multiple tests showed consistent results. The major issue with these old designs was the poor distribution patterns. The sprinkler heads were not located at the edges of growing areas, so significant numbers of pots (mainly at the edges) were not getting as much water in a given irrigation time. This necessitated longer irrigation times and frequent hand watering. Combined with the older high output sprinkler heads, we were ending up with large amounts of runoff water to process. After evaluating these areas and recognizing the problems, recommendations were made on system alterations to improve water-use efficiency. Major alterations made were:

- Shadehouse — Toro Waterbird sprinklers on a 4.67 m × 4.5 m spacing
- Polyhouse — Toro Waterbird sprinklers on a 5.4 m × 5.2 m spacing

There were also modifications to the pumping and control valves to minimize pressure variation within each section. The irrigation controller and pump were upgraded to incorporate a variable speed drive, which allows multiple sections to be irrigated simultaneously while maintaining pressure at optimum levels. New control valves incorporated adjustable pressure regulators to further ensure stable system output.

**Table 1.** Results of irrigation system improvements.

	Shadehouse		Polyhouse	
	Old irrigation design	New irrigation design	Old irrigation design	New irrigation design
Mean application rate (mm/h)	14.5	10.7	21.1	9.7
Coefficient of uniformity	79.7%	88.5%	71.0%	82.5%
Scheduling coefficient	2.3	1.2	4.0	1.4

So, after all this, just how much water is being saved? It is clear that the design modifications have lowered the mean application rates, and improved distribution patterns. But what is the actual amount of water being saved?

A single shadehouse irrigation event on a standard irrigation section is typically 4 mm of water. On the old design, this would require 16 min of irrigation, plus an additional 20 min to fully irrigate the driest part of the irrigation pattern, a total of 36 min. On the new design, it would require 22 min, but just 4 min to irrigate the driest part of the irrigation pattern. This is 10 min less pumping time on each section, or about 18,000,000 L total of water in a year.

Likewise in the polyhouses, to apply 4 mm of irrigation with the old design would take 45 min. With the improved coverage, it takes 34 min, 11 min less on every irrigation, which equates to about 250,000 L of water saved in a year.

## OVERVIEW OF THE NEW SYSTEM

In the year following the expansion, the nursery had used 13% more water to ir-

rigate 85% more plants. The reduction in output is a saving in applied water costs, and also a reduction in the amount of run-off which needs to be dealt with. The new pump and controller allow more flexibility in planning irrigation. A pressure sensor and auto switch allow irrigation water to be used for hand hoses and tractor filling points, rather than more expensive "town water." Temperature sensors allow for automatic cooling in heat waves, and frost protection in winter.

We have learnt that making savings in water use requires an approach beyond just designing a new irrigation system. The lower output heads of the new system are more prone to wind drift, and on particularly windy days, the distribution pattern still lacks excellent coverage. As yet, hand watering of dry spots is still required, though on calm days is much reduced.

Overall, saving water is a complex process of planning and requires an integrated approach to design and the requirements of the crops being produced.

---

## Water Disinfecting Techniques for Plant Pathogen Control®

**William Yiasoumi**

NSW Department of Primary Industries, Locked Bag 4, Richmond NSW 2753

**Water for irrigation is becoming harder to get and more expensive. In addition, the environmental performance of industries, including nursery production, is under public scrutiny. Water recycling addresses these issues but introduces challenges to embrace technologies and procedures to ensure plant-safe water reuse. The provision of disease-free water is part of this challenge.**

### INTRODUCTION

Many water sources for plant production need some form of treatment before the water can be reliably used for irrigation. Water treatment includes avoiding algal blooms, preventing precipitation of solid particles, controlling iron, and water disinfection.

Water disinfection is a treatment to reduce the risk of introducing disease via irrigation water and to control bacterial growth in the system. Many disease-causing organisms are easily transported in irrigation water from diseased plants to healthy ones. For example, *Fusarium* and the root rot causing fungi, such as *Phytophthora*, are readily spread.

### PRETREATMENT

There are a number of disinfection techniques available and their effectiveness is affected by different aspects of water quality. Disinfection will be a lot easier, effective, and generally cheaper if the water is "clean" before treatment. It is a good idea to pretreat the water so that it is free of heavy sediments, floating material, fine colloidal clays, and organic matter. Beardsell and Bankier (1996) provide further detail on monitoring and treatment of recycled water for nursery production.

**Heavy Sediments (Sands and Gravel).** These can be removed in a sediment trap at the end of open drains. Water passes through a pool and the velocity that is carrying the sand and gravel along is reduced. This makes the sediments fall to the bottom of the pool. The trap needs regular cleaning to remain effective.

rigate 85% more plants. The reduction in output is a saving in applied water costs, and also a reduction in the amount of run-off which needs to be dealt with. The new pump and controller allow more flexibility in planning irrigation. A pressure sensor and auto switch allow irrigation water to be used for hand hoses and tractor filling points, rather than more expensive "town water." Temperature sensors allow for automatic cooling in heat waves, and frost protection in winter.

We have learnt that making savings in water use requires an approach beyond just designing a new irrigation system. The lower output heads of the new system are more prone to wind drift, and on particularly windy days, the distribution pattern still lacks excellent coverage. As yet, hand watering of dry spots is still required, though on calm days is much reduced.

Overall, saving water is a complex process of planning and requires an integrated approach to design and the requirements of the crops being produced.

---

## Water Disinfecting Techniques for Plant Pathogen Control®

**William Yiasoumi**

NSW Department of Primary Industries, Locked Bag 4, Richmond NSW 2753

**Water for irrigation is becoming harder to get and more expensive. In addition, the environmental performance of industries, including nursery production, is under public scrutiny. Water recycling addresses these issues but introduces challenges to embrace technologies and procedures to ensure plant-safe water reuse. The provision of disease-free water is part of this challenge.**

### INTRODUCTION

Many water sources for plant production need some form of treatment before the water can be reliably used for irrigation. Water treatment includes avoiding algal blooms, preventing precipitation of solid particles, controlling iron, and water disinfection.

Water disinfection is a treatment to reduce the risk of introducing disease via irrigation water and to control bacterial growth in the system. Many disease-causing organisms are easily transported in irrigation water from diseased plants to healthy ones. For example, *Fusarium* and the root rot causing fungi, such as *Phytophthora*, are readily spread.

### PRETREATMENT

There are a number of disinfection techniques available and their effectiveness is affected by different aspects of water quality. Disinfection will be a lot easier, effective, and generally cheaper if the water is "clean" before treatment. It is a good idea to pretreat the water so that it is free of heavy sediments, floating material, fine colloidal clays, and organic matter. Beardsell and Bankier (1996) provide further detail on monitoring and treatment of recycled water for nursery production.

**Heavy Sediments (Sands and Gravel).** These can be removed in a sediment trap at the end of open drains. Water passes through a pool and the velocity that is carrying the sand and gravel along is reduced. This makes the sediments fall to the bottom of the pool. The trap needs regular cleaning to remain effective.

**Floating Material.** This can be removed at the collection point of run-off from any media storage areas, at the car park, and at the end of the drains from production areas. A simple baffle system removes media, oils, polystyrene, plastic, and plant material. It needs to be cleaned regularly.

**Removing Clay Particles.** This can be achieved with a flocculating agent like alum (aluminium sulphate) to clarify the water, preferably in a tank rather than a dam. Better still, avoid the problem in the first place and keep clay colloids out — seal catchments that collect recycling water and keep dam catchments well grassed.

**Organic Matter.** Organic matter can be removed by filtration. The best filters to use are media filters with 1-mm crushed basalt. This material is very angular and hooks organic matter effectively. Disc filters can also be used but must be fitted with at least 60-micron openings.

## DISINFESTATION TREATMENTS

Water sources can be disinfested using nonchemical methods such as heat, ultraviolet radiation, and filtration or chemical treatments such as chlorine, chlorobromine, chlorine dioxide, and ozone.

### NONCHEMICAL DISINFESTATION

**Heat Disinfestation.** This is effective in killing waterborne pathogens. Water is collected in a tank after being filtered and is then pumped into the first of two heat exchangers. The water is preheated here using the heat lost as the disinfested water that has already been through the system cools. Next the water is pumped to a second heat exchanger. The disinfested water is then stored in a separate tank until needed.

One gigajoule of gas in the second heat exchanger provides enough energy to treat about 10,000 litres of water. Gas prices vary widely within Australia. You will need to check prices locally before contemplating heat as a disinfestation system.

**Micro-filtration.** Filtration of water through very fine filters almost completely eliminates *Phytophthora* and most other waterborne pathogens, but, because the filter pores get clogged, this system needs regular maintenance. Recent technology improvements have increased the filter life to the point where they are now more cost competitive than just a few years ago.

**Ultraviolet Radiation.** Ultraviolet radiation (UV) is widely used in disinfecting drinking water. Mebalds et al. (1996) found that UV radiation is also an effective and environmentally friendly treatment for controlling *P. cinnamomi*, *F. oxysporum*, and *Alternaria zinniae*.

However, the water requires greater than 60% UV transmission after filtration. Have your water tested for turbidity before considering this method, as the water has to be free from suspended particles and tannins (iron and manganese ions absorb UV light, as do coloured chelates). A survey found that very few growers had water sources with UV transmission rates over 60%. Filtering generally does not greatly improve UV transmission of water, but it is a key element in UV treatment as it is needed to remove solids that may protect fungal spores from radiation.

**Slow Sand Filtration.** Slow sand filtration passes water slowly through a medium (sand or manufactured volcanic rock fibres) and microorganisms, living in

the filter, kill pathogenic bacteria and fungi. Soon after the filter process begins, a skin forms on the surface of the filter bed. It is made up of organic and inorganic material and a wide range of biologically active microorganisms that breakdown organic matter.

Gail Barth (1998) found that irrigation water with a high algal or silt content needed pre-filtering prior to slow sand filtration. In terms of effectiveness, Barth (1998) recommends a layer of 100 mm of water be maintained over the filter surface and that this layer of water be constantly circulated with the use of a small pump from the overflow tank or from the filtered reservoir.

## CHEMICAL DISINFESTATION

**Chlorination.** Chlorination is the most widely used disinfectant in the ornamental industry. One of chlorine's biggest advantages is its ability to provide a stable residual that helps clean slimes out of the irrigation system as well as benches and paths. If chlorine is to be effective in controlling the spread of pathogens, it is essential to accurately control both the free chlorine content and the pH. Chlorination is unsuitable if the pH of water is above 7.5. Unfortunately a survey of recycled water in Australian nurseries has shown that its pH is often above 7.5, so acidification prior to chlorination is necessary.

Chlorine comes in a gas, liquid, or powder form. Current safety requirements preclude gas. Liquid (sodium hypochlorite) is more convenient for accurate dosing than powder. Check the free chlorine percentage of your sodium hypochlorite, as it varies in different states of Australia. A metering pump is used to accurately supply the desired concentration of residual free chlorine. These pumps can be used to adjust the chlorine rate to meet the range of water quality variation throughout the season.

When using chemical solutions in an irrigation system on town water, a suitable backflow device is required to stop reversed flow to the water service.

**Chlorobromination.** Bromine has a similar action as chlorine in disinfecting water. Just as chlorine needs to form hypochlorous acid, so too, bromine needs to be formed into hypobromous acid to be active. This is best done by adding sodium bromide to sodium hypochlorite. Thus chlorobromination provides two oxidising agents, hypobromous acid and hypochlorous acid.

Hypobromous acid is a very effective disinfectant over a wide pH range. At pH 8.5, 60% of bromine is still present as hypobromous acid whereas with chlorine very little hypochlorous acid remains at pH 8.5. Recycled water commonly used in horticulture contains various and fluctuating levels of ammonium and other nitrogen-based compounds. Both bromine and chlorine react with these compounds to form bromamines and chloramines. Chloramines are poor biocides, while bromamines show disinfection properties comparable to free bromine which means less chemical should be required when using bromine.

**Chlorine Dioxide.** Chlorine dioxide is a greenish-yellow gas that is relatively unstable and cannot be stored or transported. For this reason it is formed on-site by combining hydrochloric acid with sodium chlorite. Chlorine dioxide concentrations are also affected by impurities in the water, and sensors need to be installed to adjust the generator output to maintain the required concentration.

Despite its complexity and high capital cost, chlorine dioxide has advantages. The material is a potent oxidant with rapid contact time kill rates at a low concentration and will work in water with pH as high as 10.



**Ozone.** Ozone is an unstable gas that occurs naturally in the earth's upper atmosphere. Passing dry air or oxygen through a high-energy electric field produces ozone. The oxidation potential of ozone is about twice that of chlorine and it reacts more rapidly and is less affected by pH and temperature. Ozone can control algae, oxidise manganese and ferrous ions, and many agricultural chemicals including some herbicides. It coagulates natural water constituents, which improves filtration.

Ozone does not produce environmentally unfriendly by-products as chlorine and bromine do. However it has a number of disadvantages. For example, it is expensive and it is difficult to measure the "residual" since it breaks down quickly.

Special consideration must be given to the materials in contact with ozone as it quickly corrodes brass, rubber, and many plastics. Stainless steel is suitable, as are silicon "O" rings. The major disadvantage is its cost. It is a highly unstable gas and must be generated on site, an expensive process. Mebald et al. (1996) has more information on the use of ozone and chlorine dioxide for disinfestation.

### TIPS FOR SUCCESSFUL DISINFESTATION

- Know the quality of the water you are treating. This can change constantly.
- Before choosing a water disinfestation strategy you should do a complete analysis of water quality over an extended period (say 12 months), as seasonal variation can be substantial.
- Whatever disinfestation system you select, pre-treatment has a big bearing on its success.
- Chemical systems need monitoring to ensure the right dose is available.
- It may be necessary to install automatic pH adjustment equipment in the system, as most recycled water has a high pH, which is unsuitable for many disinfestation systems.
- If you are adding nutrients to your water, wait 30 min after treatment before injection.
- Where frequent backflushing of the filter is required, automation may be desirable (adapted from Rolfe et al., 2000).

### LITERATURE CITED

- Barth, G.E.** 1998. Investigation of sand filtration for nursery recycling systems, final report for HRDC project NY413, Horticultural Research and Development Corporation, Gordon, NSW.
- Beardsell, D.** and **M. Bankier.** 1996. Monitoring and treatment of recycled water for nursery and floriculture production, final report for HRDC project NY515, Horticultural Research & Development Corporation, Gordon, NSW.
- Mebalds, M., Andrea van der Linden, M. Bankier,** and **D. Beardsell.** 1996. Using ultra violet radiation and chlorine dioxide to control fungal plant pathogens in water. The Nursery Papers No. 5. Horticultural Research & Development Corporation, Nursery Industry Association of Australia.
- Rolfe, C, W. Yiasoumi,** and **E. Kescula.** 2000. Managing water in plant nurseries. NSW Agriculture.

## Growing Plants in Hot Climates®

**Robert Chin**

Nursery & Garden Industry Victoria, PO Box 431, East Caulfield VIC 3143

### INTRODUCTION

Hotter weather is one of the greatest challenges in a production or propagation nursery in Australia. Our earliest growers from Europe struggled with growing plants in Australian conditions because they were used to the cooler temperatures and lower light levels. It is very hard to grow or propagate plants well when it is so hot. This puts growers in hotter climates at a disadvantage that they need to overcome in order to compete with growers in cooler climates.

So, how do you grow and propagate plants well? What does summer mean to you in your nursery? And, what should you be doing to minimise climatic impact? It is very difficult to grow plants from climates that are so different to ours.

### THE HOT CLIMATE IN MILDURA

Very hot climates like the Mildura region are conducive to growing good fruits and vegetables but present some significant challenges for the local plant producers. Not only is it hot here, but also it is also dry and evaporation is high.

Figures 1, 2, and 3 show the variation in temperatures and climatic features of Mildura relative to other Australian cities (source of data: Bureau of Meteorology).

### WHY BE CONCERNED ABOUT THE HEAT?

It is simple to say that it is harder to grow temperate plants in the heat, but why is it so? This is not meant to be a plant biology lesson but a brief description will help. A plant is all about its leaves and roots. Plant leaves are thin and therefore heat up and cool down very fast. Plants transpire — it is their cooling system; water is brought up from the roots and evaporates from the leaves through the stomata. If the temperature gets too high or the humidity gets too low, the plant can't move enough water up from the roots to the leaves, so the stomata start to close to prevent further dehydration. This slows water uptake, which reduces nutrient uptake. When stomata close, plant growth virtually stops, so in hot periods, there is often very little growth and leaf and fruit cells start to collapse and die. This normally happens when the leaf temperature gets to 35 °C.

Heat also has the following direct and indirect impacts in the nursery:

- Can burn or scald plants, foliage, and flowers — caused by dehydration.
- Reduces moisture available to a plant in growth medium.
- If root temperatures get too high it will slow down plant growth. Plants in pots will heat up quickly. Ideal medium temperature is between 15–30 °C.
- Heat is often associated with hot winds that also increase transpiration.
- Seed germination and root initiation on cuttings are particularly susceptible to hot weather. The larger the root system the greater the plants ability to cope with hot weather.
- Makes it harder for your workers to perform at their peak.

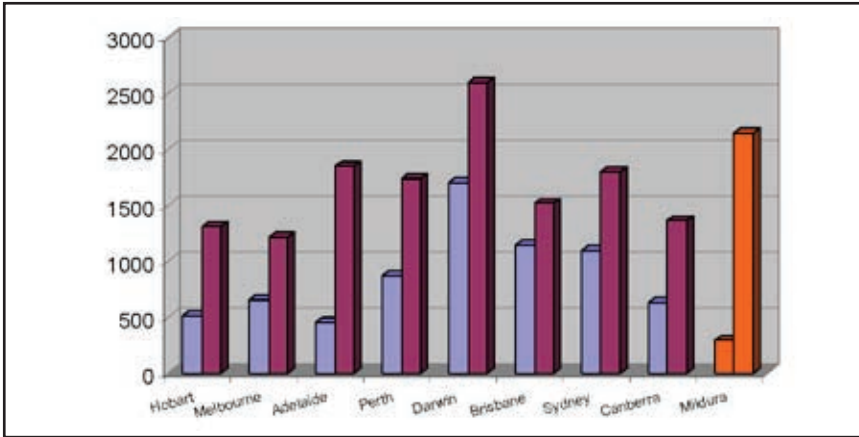


Figure 1. Annual rainfall in mm (left column) and evaporation in mm (right column) for each Australian capital city and Mildura.

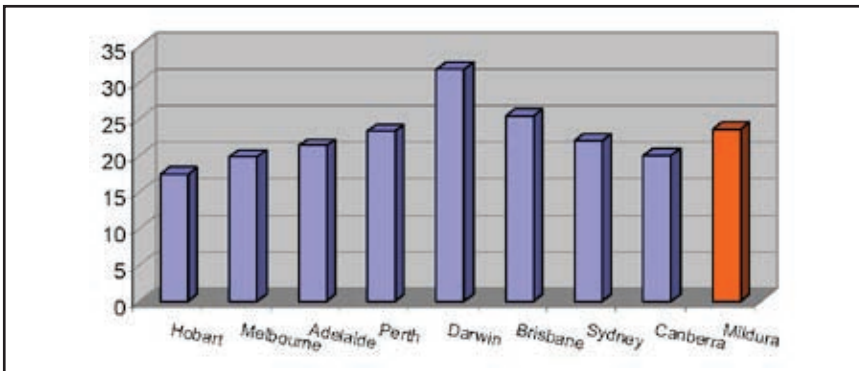


Figure 2. Average temperature (°C) in the Australian capital cities and Mildura.

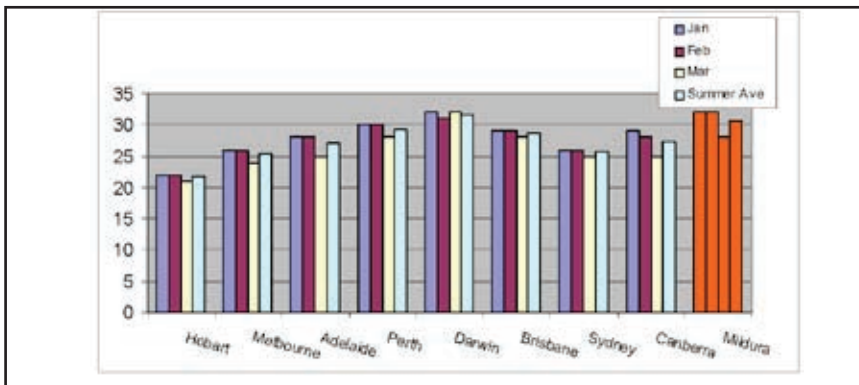


Figure 3. Average summer temperature (°C) in Australian capital cities and Mildura.

## WORKING AND COPING WITH THE HEAT IN NURSERIES

So what are the mechanisms, coping actions, and other management systems you need to put in place in the hotter weather? I have outlined some strategies for you to consider in your nursery business.

**Irrigation Systems.** Sprinklers work to put water on plants and irrigation can be used for cooling down the plants on hotter days.

- Ensure that you have a well designed and correctly functioning sprinkler system. Concentrate on the potentially dry bits (corners, along the aisles, and northerly groups of plants).
- Ensure that all plants are getting watered, even on hotter windy days, and that water isn't being wasted.
- Plants in pots will die very quickly in summer and reduced growth rates due to water stress can be significant.
- If possible, group plants with similar water requirements in the same area to allow most flexibility in sprinkler run times and frequencies.
- Use pulse watering to cool plants outside.
- Precipitation rates of sprinklers should aim to match the ability of the potting mix to take the water up.
- Consider, drip, capillary matting, and flood and drain as superior water-saving systems.

**Irrigation Cycles.** Summer watering is quite different; in fact you should change your watering cycles regularly to match the season. Automatic irrigation systems are great in the nursery but the controllers that operate them do not know it is summer unless you tell them by changing their cycles. Plants require extra water in the hotter weather to cool down.

- Aim to water plants according to their needs.
- Normal watering should be finished before the sun comes up to minimise the losses due to wind and evaporation.
- Supplementary watering is often necessary but is time consuming and expensive.

**Water Supply and Storage.** Summer is the time when everybody else is using more water as well, but summer is not the time to consider this — it is too late. Planning for summer water needs is a job for the cooler months. In summer water availability is typically reduced and the flow from bores can also be lower. Be aware of the following factors regarding water supply over summer:

- Dams get lower and salt levels will increase in the water, which might harm plant tissue and cause nutrient imbalances.
- Flow levels in rivers, creeks, and aqueducts may be affected. The effects of this are compounded in periods of extended dry.
- Water supply might not be guaranteed in some areas most severely affected by heat (e.g., bushfires will reduce pressure, might cut off power, etc.).
- Plans should be made for the worst case scenario and now is probably a good time to think about long-term water needs, including recycling and treatment, if you are not already doing so.
- Always have an adequate amount of water in storage with good back-up systems.

**Fertiliser and Nutrient Management.** Plant nutrient requirements will also change in summer and this should be planned for. Plants need more water for cooling but not necessarily more of all the nutrients.

- Check your fertiliser regime in conjunction with your media and/or fertiliser manufacturer.
- Increased watering will increase the possibility of leaching of nutrient salts from your pots.
- Liquid feeding is more popular than ever — check your percentages and ratios, in particular those of the water-soluble nutrients.
- Urea-based fertilisers like isobutylenediurea (IBDU) are potentially dangerous in hotter weather if rates are not right.

**Spraying and Chemical Applications.** Whilst the hotter, drier weather will mean that generally you will have less pests and disease, mites do love the hot dry weather. In summer you may also have increased weed growth. Spraying is still required and you need to be aware of the implications of hotter weather on your pest management system. Spraying on hot days is a very risky business especially with volatile chemicals.

- More spray is lost due to evaporation and the northerly winds will increase potential for damaging drift. Ensure you don't spray on hot windy days.
- Try to limit sprays on hot days because the chemicals may damage the foliage or flowers on the plants by marking. Efficacy of chemicals can be increased in hotter weather. The potential for marking with adjuvants/stickers is increased.
- If you are using recycled or dam water then the pH of this may change over the summer period — this may have an impact on a chemicals efficacy
- Chemical stores can get too hot and vapours can be an OH&S issue — be aware of this.

**Potting Media.** If media is crucial to growing plants then be aware of the affects and variations that the heat might cause in production and propagation media.

- Increased temperatures can cause a premature release of the salts in fertilisers in potting mix, i.e., controlled-release fertilizer (CRF) dumping.
- If you do have to store the media for extended periods ensure that the mounds are kept low (less than ½ m in height) if they contain CRF. If salts do build up then make sure plants are thoroughly watered in.
- Don't allow the media to completely dry out as this can increase the risk of airborne particles. Wet it down to keep it cool as well.
- Temperate plants are more affected by release variations — leaching may be necessary.

**Staff and Heat.** Like plants, your staff can wilt under the pressure of the excessive heat in summer. Ensure that your staff is well protected.

- Ensure all staff wear adequate protective clothing and other personal protective equipment including, wide-brimmed hats, long sleeve shirts, and a sunblock with a high SPF.

- Consider extra breaks on the hottest days for extra drink breaks and relief from the hot sun.
- Consider the provision of temporary shade structures.
- Be aware of the signs of sunstroke and other heat related illness.
- Plan the working day so the tasks that are done in the sun or in hot greenhouses are done in the cooler parts of the day.
- Hot dry weather means that potting mix and other particles dry out and become more of a hazard. Staff should be particularly aware of dust from potting mix in hot, dry weather.

**Growing Structures.** Growing plants indoors successfully in hot climates is all about design. Good house design will allow you to grow plants in them regardless of temperatures outside — cold or hot. Air movement and ventilation are crucial. Ventilation can be natural (passive) or supplemental (forced air), both are utilised to cool things down in warmer weather.

- Natural ventilation — roof or sidewall vents allow hot air to escape. Typically the open area should be no less than 20% of the floor area, but 25% is optimum. High greenhouses ventilate much better than low ones and 4 m to the gutter is now common.
- Ventilation should be automatic, ideally based on thermostats, not time.
- Misting can be used to cool greenhouses as well.
- Utilise whitewash and shade cloth in the warmer months but do not forget to remove them when it starts cooling down. White shade cloth is better than black or green because it reflects more light, but still absorbs about 20% of the heat. Aluminium screens and other mechanical methods of shading work well and repay the capital investment quickly, achieving 6–7 °C variations under aluminium screens.
- Exhaust fans can be used when there is insufficient natural ventilation. Exhaust fans are cheaper to install than motorised vents, but they are noisier and use a lot more power.
- Exhaust fans should be sized to give 30–60 air changes per hour. Inlets for exhaust fans should be 1.5 times the area of the fan outlet.

**Evaporative Cooling and Misting Growing Structures.** Both systems are used, though misting is more common.

- Fog is much more common and can give a larger and more even drop in temperature of up to 14 °C on hot, dry days.
- Always have back-up systems (pumps and power) available for misting systems and check nozzles regularly to sure that they are not blocked.
- Effectiveness of cooling in houses is dependent on relative humidity.
- Using misters can increase humidity, which can be a negative side effect.
- Droplet size is crucial — not too big!
- Low-pressure misting systems are becoming more commonplace and are proving to be effective.

**Stock Plants.** In propagation, the best result comes from healthy stock plants and the best plants in pots come from healthy cuttings. Reducing stress levels of stock plants will give you the best results.

- Stock plants need to be well watered to maintain vigour.
- Reduce potential competition by removing weeds, mulching, or using a weed mat.
- Reduce stress levels by ensuring pests and diseases are well controlled.
- Sensitive stock plants can be grown in protected environments.
- Take cuttings in the cooler parts of the day and use immediately or cool down if storing (4 °C is ideal).
- Take wet towelling or wet paper into the field to wrap the cuttings. This allows evaporative cooling of the cuttings.

### OTHER POINTS ON HOT WEATHER

**Flower colour** is often different in Australia to what you might see in Europe. They either wash or fade out faster, or are lighter as they fade in higher light levels.

**Insect screens** are desirable in greenhouses but do reduce ventilation.

**Wind and air movement** are good for plants and cooling. This often conflicts with some of the other things that we are trying to do with growing plants though. Too much wind can be a bad thing. Consider properly spaced windbreaks.

**Despatch and transport** in hot climates needs to be carefully planned. Plants in trucks or on tarmacs get very hot and can expire quickly. If you want your plants to arrive in good condition at your customers nursery then be aware of this and plan to avoid it!

**Plants from hot climates** grow better than plants from temperate or cold climates in hot places like Mildura. It is easier to grow plants that originate in hotter climates in these areas. Some taxa of the same genus and species will vary in their ability to cope with heat. Refer to the Diggers Heat Zone Map for details (<<http://www.diggers.com.au/GrowingGuides.htm>>). The map shows the various locations around Australia that are climatically similar (i.e., they have the same number of hot days above 30 °C). This will give us an indication of how you would expect Australian plants from the various climate zones to grow and cope with hotter weather.

### CONCLUSION

Hot weather just happens; it seldom sneaks up on you. It comes at the same time every year. Be prepared and you will cope well. The hotter part of the year is inevitable; you can't stop it, but you can live with it and so can your plants.

**Acknowledgements.** I would like to acknowledge the organising committee of IPPS for inviting me to make this presentation. Thanks also to Carl Van Loon (Powerplants) and David Nichols (Debco) for feedback and comments on this presentation and Clive Blazey (Diggers Club) for allowing the use of the Diggers Heat Zone Map. Finally I would also like to thank those nursery businesses that I have called on in the preparation of this paper.

### LITERATURE CITED

- Bureau of Meteorology (Australia).** Rainfall and climatic statistics. Web site: <[www.bom.gov.au](http://www.bom.gov.au)>.
- Diggers Club.** Heat zone map. Web site: <<http://www.diggers.com.au/GrowingGuides.htm>>.



# A Weed or a Rose? The New Zealand Hazardous Substances and New Organisms Act<sup>®</sup>

**Libby Harrison and Geoff Ridley**

Environmental Risk Management Authority (ERMA New Zealand), PO Box 131, Wellington

## INTRODUCTION

Williams et al. (2001) estimates that there are approximately 160 alien species that require some form of control in New Zealand, 1,900 adventive species whose weed risk status needs assessing, and a further 18,000 species in cultivation, of which at least 4,000 are listed as weeds in other countries. In 2002 Timmins and Popay estimated that 240 species of invasive weeds were threatening indigenous biodiversity and that 75% of New Zealand's environmental weeds were originally introduced as garden plants. They also estimated that there is a pool of 20,000 to 25,000 introduced plants in cultivation of which 2,100 have become naturalized, and Essler (1988) calculated that four new species are naturalised every year in the Auckland urban area. It is further estimated that:

- 1%–2% of all introductions will become significant environmental or agricultural weeds (Williams et al., 2000);
- Weeds have invaded nearly all types of indigenous plant communities (Williams, 1997);
- Over one-third of off-shore islands have a weed problem (Atkinson, 1997);
- Weeds will degrade approximately 575,000 ha within 10–15 years if no controls are implemented (Buddenhagen et al., 1998);
- Weeds are a direct threat to one-third of all New Zealand's nationally threatened plant species (Reid, 1998);
- Of 117 taxa recorded as naturalised between 1988 and 1993 16% were probably accidental contaminants, while 84% were horticultural escapees from gardens and amenity plantings (Lee, et al., 2000);
- It has been conservatively estimated that the cost of managing weeds and pests is \$840 million or 1% of gross domestic product (GDP) (Hackwell and Bertram, 1999).

## THE ACTS

It was with this knowledge that both the Biosecurity Act 1993 (BA, 1993) and Hazardous Substances and New Organisms (HSNO) Act 1996 (HSNO, 1996) were drafted and passed by the New Zealand Parliament. The purpose of the HSNO Act "is to protect the environment, and health and safety of people and communities, by preventing or managing the adverse effects of new organisms." The HSNO Act is effects-based, and decisions are made by weighing up positive (benefits) and adverse effects (risks or costs). However, the Act requires that a precautionary approach be taken where there is scientific and technical uncertainty about adverse effects. Further there is a set of minimum standards that require an application to be declined if there is likely to be:

- Any significant displacement of any native species within its natural habitat,

- Any significant deterioration of natural habitats, and
- Any significant adverse effects to New Zealand's inherent genetic diversity, or
- A disease or parasite, or a vector of a disease or parasite of humans, animals, or plants unless that is the purpose of its introduction.

This was a significant change in policy at least in regards to the introduction of new plant species, which had been virtually uncontrolled for the previous 150 years.

## NEW PLANT INTRODUCTIONS

Since the New Organisms component of the HSNO Act came into force in 1998 there have been only two applications for plants species to be unconditionally released, using the rapid assessment provisions, into the New Zealand environment. These were for *Xanthorrhoea glauca* and *X. johnsonii*, Australian grass trees, and 11 species of *Agathis*. The former was approved while the latter was not approved due to the uncertainty surrounding the cultural dimension of risk to kauri (*Agathis australis*). In the latter case the applicant did not pursue any of the other available avenues of release. The lack of applications is thought to be a result of the plantmen perceiving that the HSNO Act process is too difficult and too expensive. While the Act is demanding, a part of the failure has been on the part of the plantmen not engaging with the HSNO Act and of ERMA New Zealand not communicating the possibilities that the provisions of the Act provides. These provisions are the determination of the new organism status of a species, and the successive steps of importation of new species into containment, field trial, conditional release, and release.

Many plantmen's first contact with ERMA New Zealand is when their importation of seeds or plants are stopped at the border by Ministry of Agriculture and Forestry's Quarantine officials because the species being imported does not occur on the Plant Biosecurity Index (PBI) (MAF, 2005). Justifiable criticism can be leveled at the implementation phase of the HSNO Act in that no provision was made to create a definitive list of all the plant species that occur in New Zealand. The PBI was an 11th hour attempt to at least have a rudimentary list in place when the HSNO Act came into force. When an importation of plants is stopped at the border for this reason the importer will be referred to ERMA New Zealand for a statutory determination as to whether or not it is a new organism under the Act. A statutory determination although free in the past will probably incur a \$1000 application fee. However, where the evidence for its presence in New Zealand is incontrovertible ERMA New Zealand has instituted a free, nonstatutory or informal process by which the evidence is evaluated and the Chief Executive issues a letter stating that the organism is not new. Where the evidence is ambiguous or lacking a statutory determination is likely to be unsuccessful.

Where a statutory determination of the new organism status of a species is unlikely to succeed or has been unsuccessful, i.e., the organism is still considered to be "new," there is a tendency for the importer to fall-back into a pre-HSNO Act mode of thinking. This usually results in the importer pursuing an application for a full release despite the high hurdles created by the precautionary principle and the minimum standards. A better, but more circuitous, approach might be to apply for an importation into containment. In containment the plant could be trialed for suitability for its intended purpose and more data gathered to assist the release application process. This could be then followed by an application to field trial or

for a conditional release. Again at each step more data could be gathered as to the suitability of the plant for its intended purpose and to gather further data pertinent to the next step. Moving through such a process will act as a sieve for species that have undesirable environment or commercial traits.

Each step in the process described will incur an application fee which will progressively increase from \$1000 through to a maximum of \$35,000, as well as infra-structural and compliance costs to maintain containment. This could be overcome by plantmen acting in the sector interest and pooling resources through an association, such as the Nursery and Garden Industry Association (NGIA), to cover the costs of applications, establishing national containment facility, and regional field trial and conditional release trial sites. Taking a generic approach to applications rather than a species-by-species approach could further enhance this. Such an approach would be welcomed by ERMA New Zealand, but it can only succeed if the sector developing a cohesive strategy.

An example of such an approach might be for an application to import into containment the hypothetical plant genus *Ermanzia* which might consist of species *E. alpha*, *E. beta*, *E. gamma*, and *E. delta*. In containment *E. alpha* is found to have weedy characteristics and is eliminated from any further consideration. A field trial application is then made to carry out the trial at a nationally established field trial site. As a result of the field trial species *E. beta* is eliminated because it has undesirable commercial traits, e.g., it is poor flowering. This is followed by an application for conditional release in regionally established trial sites in Auckland, Christchurch and Dunedin. The results of the trials are that species *E. gamma* performs well in all three sites but *E. delta* only does well in Christchurch and Dunedin. The developer of these plants may then choose to pursue full release with the knowledge that the *E. gamma* will only be made commercially available in the South Island while *E. delta* will be commercially released nationally, or the release of *E. gamma* will not be pursued, as it is not economically viable. Such an approach is both commercially and environmentally sensible when compared with the non-evaluated release of a plant species.

Another possibility might be where species traits allow the conditions to be placed on what would be to all intents and purposes a release. Such controls would be to mitigate any risk that the species might become invasive. One example of this would be a dioecious species, in which there are separate male and female plants as in the case of the maidenhair tree (*Ginkgo biloba*). A condition that could be put on such a species would be that no female plants were to be imported or released. The result would be species that could not become invasive. Such controls would satisfy many of the hurdles created by the precautionary principle and minimum standards.

## CONCLUSION

In conclusion, the HSNO Act was implemented for the purpose of protecting New Zealand from the importation of further undesirable plant species. As such it needs to be noted that the Act is now part of the horticultural landscape and needs to be engaged by those who wish to pursue the importation of new species. It is believed that by taking a strategic sector approach to the HSNO Act rather than an individual approach many of the obstacles, both real and perceived, created by the precautionary principle and the minimum standards can be used to the advantage of the sector and the individual plantmen.

**LITERATURE CITED**

- Atkinson, I.A.E.** 1997. Problem weeds on New Zealand islands. Department of Conservation, Science for Conservation No. 45.
- Biosecurity Act 1993.** (BA, 1993). Public Access to Legislation Project. Parliamentary Counsel Office, New Zealand Government. <[http://www.legislation.govt.nz/browse\\_vw.asp?content-set=pal\\_statutes](http://www.legislation.govt.nz/browse_vw.asp?content-set=pal_statutes)> (Search "Biosecurity").
- Buddenhagen, C., S.M. Timmins, S.J. Owen, P. Champion, W. Nelson, and V.A Reid.** 1998. An overview of weed impacts and trends. In: S.D. Owen (ed.) Department of Conservation Strategic Plan for Managing Invasive Weeds. Department of Conservation: Wellington.
- Essler, A.E.** 1988. The naturalisation of plants in urban Auckland, New Zealand. 5. Success of the alien species. *N. Z. J. Bot.* 26:565–584.
- Hackwell, K. and G. Bertram.** 1999. Pests and weeds: the cost of restoring an indigenous dawn chorus: a blue print for action against the impacts of introduced pest organisms on the New Zealand environment. New Zealand Conservation Authority: Wellington.
- Hazardous Substances and New Organisms Act.** 1996 (HSNO, 1996) Public Access to Legislation Project. Parliamentary Counsel Office. New Zealand Government <[http://www.legislation.govt.nz/browse\\_vw.asp?content-set=pal\\_statutes](http://www.legislation.govt.nz/browse_vw.asp?content-set=pal_statutes)> (Search "Harzardous").
- Lee, W.G., P.A. Williams, and E. Cameron.** 2000. Plant invasions in urban environments - the key to limiting new weeds in New Zealand, pp. 43–58. In: Suckling, D.M. and P.S Stevens. (eds.) *Managing Urban Weeds and Pests.* Proc. N. Z. Plant Protection Soc. Symposium, The Centra Hotel, Auckland Airport, August 9th, 1999.
- Ministry of Agriculture and Forestry.** 2005 (MAF, 2005) Plant Pests and Diseases. Plant Biosecurity Index. Biosecurity New Zealand, Ministry of Agriculture and Forestry. <<http://www.biosecurity.govt.nz/pests-diseases/plants/index.htm>>.
- Reid, V.A.** 1998. The impact of weeds on threatened plants. Department of Conservation, Science and Research Internal Report 164.
- Timmins, S.M., and A.I. Popay.** 2002. The scientific approach to managing New Zealand's environmental weeds, pp. 101–108. In: Goldson, S.L. and D.M. Suckling, (eds.) *Defending the Green Oasis: New Zealand Biosecurity and Science.* New Zealand Plant Protection Society: Christchurch.
- Williams, P.A.** 1997. Ecology and management of invasive weeds. Department of Conservation, Conservation Science No. 7.
- Williams, P.A., and M. Newfield.** 2002. A weed-risk assessment system for new conservation weeds in New Zealand. Department of Conservation, Science for Conservation 209.
- Williams, P.A., E. Nicol, and M. Newfield.** 2000. Assessing the risk to indigenous New Zealand biota from new exotic plant taxa and genetic material. Department of Conservation, Science for Conservation 143.
- Williams, P.A., E. Nicol, and M. Newfield.** 2001. Assessing the risk to indigenous biota of plant taxa new to New Zealand, pp. 100–116. In: Groves, R.H., F.D. Panetta and J.D. Virtue, (ed.) *Weed Risk Assessment.* CSIRO Publishing: Collingwood, Victoria.

## Regulatory Barriers to Introducing New Plants Need to Be Minimized to Grow the New Zealand Economy<sup>©</sup>

**Jim Douglas**

New Zealand Institute for Crop & Food Research Limited, Ruakura Research Centre, Hamilton

### EXOTIC PLANTS ARE OUR WEALTH

Exotic plants and animals have made New Zealand a wealthy country. In 2003–04, 64% of New Zealand's exports came from primary land-based industries (Table 1). These industries are almost totally built on exotic plant species. Pastoral agriculture is dominantly based on ryegrass and white clover from Europe, forestry on the Monterey pine (*Pinus radiata*) and Douglas fir (*Pseudotsuga menziesii*) from Western U.S.A., and horticulture dominated by kiwifruit (*Actinidia*) from China and apples from central Asia. Horticultural exports are made up of a much more diverse mixture of species than agriculture or forestry and over 20 fruit, 15 vegetable, and 10 ornamental species are separately itemized in the export statistics (HortResearch, 2004). All the species listed in the horticultural export statistics are exotic plants from around the world except for two native species, sphagnum moss (*Sphagnum cristatum*) and *Pittosporum* (HortResearch, 2004). Together these two products contributed \$8.6 million, which is a very small percentage of the \$2.2 billion horticultural exports in 2003–04. Some native species would also be included in the export statistics under the collective plants and foliage items but these groups are also very small (\$15.3 million) compared to the total export return.

**Table 1:** Land-based primary industry export receipts 2003–04.

	NZ \$ billions
Agriculture	13.05
Forestry	3.23
Horticulture	2.22
Subtotal	18.5
Total exports	28.7

(Source: Ministry of Agriculture and Forestry, 2004a.)

New Zealand growers are internationally recognised for being innovative and developing new crops. In addition to kiwifruit, commercial development has created international markets for South African *Zantedeschia* and *Sandersonia* as cut flowers and for South American feijoas [*Acca sellowiana* (syn. *Feijoa sellowiana*)] and tamarillos (*Cyphomandra betacea*) as export fruit. The ornamental industry in particular is continually searching for new colour and form in flowers, foliage, and plants to gain a market edge as fashions and demand change. These developments were made possible by the free flow of plant species into New Zealand that occurred in the past. Future developments will require a constant flow of new plant material so that new species can be evaluated and appropriate colours and forms selected and bred for international markets. Research and development and innovation

have been key drivers of the horticultural industry in the past and are likely to be key determinants of future growth (Ministry of Agriculture and Forestry, 2004b). Innovation has not only played a key role in the development of horticulture but is also seen by government as a general requirement to return New Zealand to the top half of the Organisation of Economic and Cooperation Development (OECD) rankings by 2011. To do this, government is committed to implementing policies that provide a framework to enable an innovative society to flourish (New Zealand Government, 2002).

## **BARRIERS TO INNOVATION**

Counter to the government policy of providing suitable business conditions to enable innovative development, the regulatory legislation of the 1990s has placed significant barriers in the path of growers and plant breeders seeking new opportunities from new plant species by virtually stopping new plant species introduction. The two pieces of legislation are the 1993 Biosecurity Act, which focused on the “exclusion, eradication, and effective management of pest and unwanted organisms”, and the 1996 Hazardous Substances and New Organisms (HSNO) Act, which focuses on the “management of hazardous substances and new organisms” (New Zealand Government, 1996, 1998). Under these Acts the Ministry of Agriculture and Forestry (MAF) administers plant health standards to keep out unwanted pests and diseases on imported plant material, and a Plants Biosecurity Index (Ministry of Agriculture and Forestry, 2005), which is a list of plant species they consider acceptable to grow in New Zealand. Species not listed on the Biosecurity Index are required to go through an environmental risk assessment before being placed on the Biosecurity Index. Currently about 27,000 plant species are listed on the Biosecurity Index, but it is well known that the Index is incomplete and some botanists estimate that there are as many as 40,000 exotic plant species in New Zealand. This means that there may be up to 50% more exotic species in New Zealand than listed by MAF and yet these plants are not officially recognised as being in New Zealand. The result of this is that germplasm of these species cannot be imported until they are placed on the Plants Biosecurity Index. Although MAF is the regulatory body it does not know what plant species are in New Zealand.

The purpose of the HSNO Act is stated as “to protect the environment and health and safety of people and communities by preventing and managing the adverse effects of hazardous substances and new organisms” (New Zealand Government, 1996). Most people would agree with this sentiment, but it is the definition of a new organism, which puts a sting in the tail. The definition is: “a species of any organism which was not present in New Zealand on the date of the commencement of this Act” (New Zealand Government, 1996). This places plant species in the same category as pathogenic microbes, insects such as fruit flies, and animals such as snakes. It is important to note that the HSNO Act is focused on the adverse effects of plants rather than the much more important beneficial attributes of most plants. From this perspective it is a justifiable argument that plants should be completely removed from the HSNO Act and the biosecurity focus concentrated only on plants with undesirable characteristics. This would return plants to their previous status of free entry into New Zealand provided they met plant health standards and were not considered undesirable. After all, exotic plants provide the developed landscape of New Zealand and are the cornerstone of the New Zealand economy and way of life.

### THE ENVIRONMENTAL RISK MANAGEMENT AUTHORITY (ERMA)

Under the HSNO Act any plant species that is not on the MAF Biosecurity Index needs an environmental risk assessment undertaken before it can be introduced into New Zealand. This is undertaken by ERMA who have a rapid and full assessment process. An application for rapid assessment costs \$500.00 and ERMA has to be satisfied that the organism is not unwanted and that it is highly improbable that the organism after release could form self-sustaining populations anywhere in New Zealand (taking into account the ease of eradication) or could displace or reduce valued species or cause deterioration of natural habitats (New Zealand Government, 1996) These definitions in the Act make it very difficult to consider plants under the rapid assessment process because little is known about the capability of many new species to form sustainable populations somewhere in New Zealand and what is known is a matter of conjecture. Since 1998 only two new species of Australian grass trees (*Xanthorrhoea glauca* and *X. johnsonii*) have been introduced under the rapid assessment regulations. Both were introduced for interior and semi-interior decoration and were seen to provide no environmental threat. Application to import 11 new species of *Agathis* was declined on the grounds of Maori cultural sensitivity, as covered by the Act, even though there are nine exotic species of *Agathis* already in New Zealand.

The full assessment procedure to enable a new species to be grown anywhere in New Zealand has an application fee of \$30,000 and entails a full environmental risk assessment. Not surprisingly, no new plant species have been introduced. In effect, the high fee has stopped new plant species coming into New Zealand and no new economic species have been introduced in the last 7 years. This is an extraordinary state of affairs for a country reliant on exotic plant species for its economic survival. It is also a very serious situation for our future economic development as an analysis by Halloy (1999) concluded that up to 20 new species needed to be developed each decade to maintain economic growth. Prior to the HSNO Act an estimated 500 to 600 new plant species were brought into New Zealand annually. In 7 years this equates to 3,500 to 4,200 species and at a cost of \$30,000 per species this represents a cost of \$105 to \$126 million or \$15 to \$18 million per year. As an example of the draconian nature of this legislation, today it is highly likely that kiwifruit would not have been allowed entry into New Zealand and we would not have had the opportunity to develop a billion-dollar industry (Douglas, 2005a). It is not surprising that no new plants have been brought into New Zealand under the full assessment programme because for many species it is not known whether they can be successfully grown until they have been tried. It is a trial-and-error process without any surety of success. Consequently, the risk of failure and losing money are high. Secondly, the primary applicant to bring a new plant species into New Zealand has to meet all the environmental risk assessment costs but once the plant is approved and placed on the MAF Plants Biosecurity Index it is subsequently allowed free entry. In essence, the implementation of the HSNO Act regulations by ERMA does not mirror the intentions of the Act, which requires the regulators to take into account the "enhancement of the capacity of people and communities to provide for their own economic, social, and cultural well-being" the economic benefits of any new organisms, and the sustainability of introduced flora (New Zealand Government, 1996). Essentially ERMA has prevented any adverse environmental effects by virtually stopping the introduction of new plant species. Environmental



risk has been overcome by eliminating the risk factor rather than managing it, without taking into account any economic, social, or cultural considerations of new plant introduction.

### **ENVIRONMENTAL RISK — HOW REAL IS IT?**

In relation to plants, the HSNO Act was brought in to manage any adverse effects of new introductions. It is therefore relevant to look at past plant introductions as an indicator of what to expect in the future. From past plant introductions it is estimated that there are 30,000 to 40,000 exotic plant species growing in New Zealand. Consequently there are 12 to 15 times more exotic plant species in New Zealand than native ones. Of these exotics, 2108 or 5% to 7% of the total exotic plant species are listed as having naturalised (Wilton and Breitwieser, 2000). Of these 154 species are recognised as pest plants and are banned nationally or regionally (New Zealand Pest Plant Manual 2005). This represents 7% of the naturalised exotic species and 0.4% to 0.5% of the total exotic flora in New Zealand. It can be concluded from these numbers that any environmental threat comes from a very low percentage of exotic species and that the majority of introduced species (99%+) pose no threat to the environment at all. From this summary there seems little justification to assess all plants coming into New Zealand for environmentally harmful effects when history shows the vast majority poses no threat at all. Government regulations in the second schedule of the HSNO Act already include a short list of prohibited plants as well as other prohibited species that are listed in the Plants Biosecurity Index. Regulating unwanted plant species seems a much more sensible approach to minimize environmental risk rather than examining the environmental risk of all new plants coming into New Zealand when most are of no environmental threat. Developing a Biosecurity Index of undesirable plants instead of acceptable plants would allow the free entry of the majority of plants into New Zealand and dispense with the cumbersome bureaucracy of the open-ended Acceptable Plant Index, which has created the barrier to innovation and development.

The importation of nursery stock of plants that are on the Plants Biosecurity Index faces an additional hurdle — the requirement to meet an import health standard. Keeping out unwanted diseases and pests is a key requirement of the national biosecurity policy but currently import standards are not available for many minor crops and no importation is permissible without one. This is a second frustration for plant importers and developers and one that needs resolution.

### **NEW PLANT SPECIES ARE NEEDED TO GROW THE ECONOMY**

The warm to temperate New Zealand environment provides ideal conditions in which to grow a very wide range of economic species. Nevertheless the number of exotic plants in New Zealand represents less than 10% of the estimated world's flowering plant flora of 422,000 (Govaerts, 2001) and many new opportunities are apparent from plant species not currently in New Zealand. Essentially, the current regulation of Government has cut New Zealand off from using this world flora as a resource to develop new products that may expand the economy. Modern transport systems mean world markets are available to New Zealand growers but there is a need for rapid action to capture the opportunities as market demands change. Fashion has an important influence on the ornamental trade, and developing new products with novel colours and forms is a key requirement to gain a market edge.

Demand for new plant products has become more sophisticated with increased emphasis on plants as resources for specific plant compounds. This is the concept of plants as factories' where new plant compounds are sought as starting blocks for new industrial products or bioactive compounds are extracted for use in foods, cosmetics, and natural medicines (Douglas, 2005b). Beneficial plant characteristics are now being identified at the molecular level and with modern plant breeding methods they can be used to enhance the economic potential of unrelated species. New plant species and their targeted development for specific end uses will be needed for new market opportunities, environmental adaptation to climate change, and resource issues such as bioenergy production. The increasing importance of identifying and understanding the constituents of plants emphasizes the need to safeguard the world biodiversity of plants for possible future use. This requires an active global policy to protect threatened and endangered species. New Zealand has a role to play in providing a safe haven for species that will grow here. Currently we cannot offer this haven for plant species not listed on the Biosecurity Index. This need and all the opportunities and benefits that new species bring require a constant flow of new plant material into New Zealand and for this to happen there need to be minimal barriers to new plant introductions.

## CONCLUSION

The biosecurity and HSNO regulations introduced in the 1990s have stopped the entry of new germplasm for evaluation, selection, or breeding within New Zealand for the last 7 years. For a country dependent on exotic species for its wealth this amounts to a national disaster. Exotic plants are the backbone of the New Zealand economy and there is a requirement for a continual flow of new plants entering New Zealand to develop new products for new market opportunities. Unless the regulations are changed the lack of new plant material coming into New Zealand is likely to have serious long-term consequences for the economy. The regulatory emphasis on the adverse environmental threat of new exotic plants is totally misplaced compared to the benefits that new plant material can bring. Plant import regulations should focus on keeping unwanted plants out of New Zealand and allow the free entry of all other plants provided they meet disease and pest health standards.

## LITERATURE CITED

- Douglas, J.A.** 2005a. Plant import rules blocking growth. *The New Zealand Herald*, 18 April 2005.
- Douglas, J.A.** 2005b. Plants as factories for nutraceuticals and functional foods. *Primary Industry Management* 8(1): 31–33.
- Govaerts, R.** 2001. How many species of seed plants are there? *Taxon* 50: 1085–1090.
- Halloy, S.R.P.** 1999. The dynamic contribution of new crops to the agricultural economy: Is it predictable?, pp53–59. In: Janick, J. ed. *Perspectives on new crops and new uses*. Alexandria, Virginia, ASHS Press.
- HortResearch.** 2004. pp. 1–33. Compiled by J.P. Kerr, E.W. Hewett, and A.G. Atken, Martech Consulting Group, Milford, Auckland. *New Zealand horticulture facts and figures 2004*. The Horticulture and Food Research Institute of New Zealand Ltd, Auckland, New Zealand.
- Ministry of Agriculture and Forestry.** 2004a. Situation and outlook for New Zealand agriculture and forestry. <<http://www.maf.govt.nz/mafnet/rural-nz/statistics-and-forecasts/sonzaf/2004/index.htm>>.
- Ministry of Agriculture and Forestry.** 2004b. Contribution of the land-based primary industries to New Zealand's economic growth. <<http://www.maf.govt.nz/mafnet/rural-nz/profitability-and-economics/contribution-of-land-based-industries-nz-economic-growth/index.htm>>.

- Ministry of Agriculture and Forestry.** 2005. MAF plants biosecurity index. <[www1.maf.govt.nz/cgi-bin/bioindex/bioindex.pl](http://www1.maf.govt.nz/cgi-bin/bioindex/bioindex.pl)>.
- New Zealand Government.** 1996. Hazardous substances and new organisms act, New Zealand Government, Wellington, New Zealand.
- New Zealand Government.** 1998 Biosecurity. Reprinted Act (with amendments incorporated), New Zealand Government, Wellington, New Zealand.
- New Zealand Government.** 2002. Growing an innovative New Zealand. <[www.beehive.govt.nz/innovate/innovate.pdf](http://www.beehive.govt.nz/innovate/innovate.pdf)>.
- New Zealand Pest Plant Manual.** 2005. <<http://www.protectnz.org.nz>>.
- Wilton, A.D. and I. Breitwieser.** 2000. Composition of the New Zealand seed plant flora. *New Zealand Journal of Botany* 38: 537–549.

---

## Unforeseen Consequences<sup>©</sup>

**Keith Hammett**

488C Don Buck Rd, Massey, Auckland

### INTRODUCTION

Every person on earth has an individual view of the world. This is influenced by the culture in which we are raised, by our education, and by individual experiences as we pass through life. Misunderstandings often arise when discussing a topic if we do not check out the other person's perceptions, or we do not clearly explain our own. I trained as a plant pathologist and converted myself into a plant breeder of both fruiting and ornamental plants. As a consequence, I have a heightened awareness of the need to balance potential benefits from importing plants against the risks.

I also believe in collective custodianship, rather than the notion that naturally occurring plants or animals can be "owned" by anyone. By this, I mean that we live in a global village and have a shared responsibility to preserve biodiversity worldwide. We do not just have responsibility for the plants and animals that happened to have evolved within New Zealand.

### IMPORTANCE OF GERMLASM

Economically New Zealand's rural industries are almost totally based on exotic germplasm, whether this be pine trees (*Pinus radiata*), roses, or cows. As a consequence, New Zealand has frequently acted as an unwitting Noah's Ark. Cultivars of several genera that have been lost elsewhere in the world have survived in gardens here in New Zealand. A good example is *Cosmos atrosanguineus*, the chocolate-scented cosmos. This plant is a native of Mexico, but has died out in its country of origin. Fifty years ago this plant was normally raised from seed. With the advent of tissue culture propagation a single clone was disseminated worldwide, displacing other strains. Individual plants of many members of the Asteraceae are self-incompatible and without other plants that are genetically distinct they are unable to set seed. This is the case with the clone currently available commercially. All vegetatively propagated cultivars become less thrifty over time and the plant was potentially in danger of being lost to cultivation as well as in the wild. Fortunately Russell Poulter of Dunedin was able to locate some remnant plants of *Cosmos atrosanguineus* that predated the tissue-cultured strain and the possibility to reestablish and further develop the plant now exists.

- Ministry of Agriculture and Forestry.** 2005. MAF plants biosecurity index. <[www1.maf.govt.nz/cgi-bin/bioindex/bioindex.pl](http://www1.maf.govt.nz/cgi-bin/bioindex/bioindex.pl)>.
- New Zealand Government.** 1996. Hazardous substances and new organisms act, New Zealand Government, Wellington, New Zealand.
- New Zealand Government.** 1998 Biosecurity. Reprinted Act (with amendments incorporated), New Zealand Government, Wellington, New Zealand.
- New Zealand Government.** 2002. Growing an innovative New Zealand. <[www.beehive.govt.nz/innovate/innovate.pdf](http://www.beehive.govt.nz/innovate/innovate.pdf)>.
- New Zealand Pest Plant Manual.** 2005. <<http://www.protectnz.org.nz>>.
- Wilton, A.D. and I. Breitwieser.** 2000. Composition of the New Zealand seed plant flora. *New Zealand Journal of Botany* 38: 537–549.

---

## Unforeseen Consequences<sup>©</sup>

**Keith Hammett**

488C Don Buck Rd, Massey, Auckland

### INTRODUCTION

Every person on earth has an individual view of the world. This is influenced by the culture in which we are raised, by our education, and by individual experiences as we pass through life. Misunderstandings often arise when discussing a topic if we do not check out the other person's perceptions, or we do not clearly explain our own. I trained as a plant pathologist and converted myself into a plant breeder of both fruiting and ornamental plants. As a consequence, I have a heightened awareness of the need to balance potential benefits from importing plants against the risks.

I also believe in collective custodianship, rather than the notion that naturally occurring plants or animals can be "owned" by anyone. By this, I mean that we live in a global village and have a shared responsibility to preserve biodiversity worldwide. We do not just have responsibility for the plants and animals that happened to have evolved within New Zealand.

### IMPORTANCE OF GERMLASM

Economically New Zealand's rural industries are almost totally based on exotic germplasm, whether this be pine trees (*Pinus radiata*), roses, or cows. As a consequence, New Zealand has frequently acted as an unwitting Noah's Ark. Cultivars of several genera that have been lost elsewhere in the world have survived in gardens here in New Zealand. A good example is *Cosmos atrosanguineus*, the chocolate-scented cosmos. This plant is a native of Mexico, but has died out in its country of origin. Fifty years ago this plant was normally raised from seed. With the advent of tissue culture propagation a single clone was disseminated worldwide, displacing other strains. Individual plants of many members of the Asteraceae are self-incompatible and without other plants that are genetically distinct they are unable to set seed. This is the case with the clone currently available commercially. All vegetatively propagated cultivars become less thrifty over time and the plant was potentially in danger of being lost to cultivation as well as in the wild. Fortunately Russell Poulter of Dunedin was able to locate some remnant plants of *Cosmos atrosanguineus* that predated the tissue-cultured strain and the possibility to reestablish and further develop the plant now exists.

Plant breeding depends on variation. Some genera exhibit a great deal of variation, while others show very little. I liken a gene pool to a box of toy bricks. The more bricks you have, the greater the possibility to produce something new. In horticulture a gene pool is simply a good collection of plants of a specific genus. However, it is important to recognize that it is extremely difficult to maintain and curate a collection over any length of time. We all lose cultivars, however careful we may be. Without constant topping up, all collections erode very quickly. It is also extremely important not to confuse the maintenance of wide diversity in a collection with simply stirring a diminishing gene pool. Very many of our garden plants have been developed from a very limited base. Often only just a few plants from a single location were introduced to cultivation and most variation that now exists has been created in cultivation.

In contrast, in nature, species have evolved over many millions of years and variant forms within species have developed that are especially well adapted to specific ecological niches. Such forms are called ecotypes and often the locations where they have evolved are very limited. In forestry it is recognized that matching a specific ecotype to specific areas where the trees are to be grown is very important, a concept known as provenance.

Provenance is equally important in ornamental horticulture and it is essential that an ongoing stream of ecotypes of species already here in New Zealand be maintained. In addition, it is essential that the ability to introduce and test species not yet established here be restored. Bear in mind that most ecotypes from the wild are very difficult to establish, let alone maintain in cultivation. Very few have any weed potential.

## INTRODUCING PLANTS

There was a time when the introduction of new plants and animals was seen to be virtuous. Until recently Government Departments were actively engaged in the responsible importation and evaluation of species and crops new to New Zealand. I was engaged in such activity during the 1980s with the Department of Scientific and Industrial Research (DSIR). Equally Acclimatisation Societies were active through much of the nineteenth and twentieth centuries, but now bodies such as the Department of Conservation promulgate the dogma “Native good—Exotic evil.”

For me, breeding ornamental plants is an art form comparable to painting, sculpture, or music. In addition to their intrinsic values, all have a commercial component. It is curious that the current Government is doing much to promote and encourage popular music in New Zealand, but at the same time is doing all it can to make the breeding of ornamental plants nonviable. I feel sure that this cannot be deliberate, but has arisen through the inability to understand the time scales involved in breeding and to be able to see the wider picture. Various Acts have been put in place with good intentions together with huge bureaucracies to implement them. Currently the Ministry of Agriculture and Forestry (MAF), the Environmental Risk Management Authority (ERMA), Biosecurity New Zealand, the Department of Conservation (DoC), and Agriquality New Zealand are the key players, and others such as local authorities also seem keen to get involved.

The interaction of these authorities and subsequent iteration appears like a classic formula of chaos theory. Compliance costs and fees alone make the importation and testing of species untenable.

It is important to understand that there are no really big players involved in the ornamental plant industry in New Zealand. The larger nurseries can justify limited importation of relatively mundane plants developed overseas, as they can be sold and expenses may be recovered within a few years. In contrast, no one is able or willing to bear the cost of importing a little known species that may or may not offer some possibility of genuine innovation. It is interesting that plants that were to become the kiwifruit (*Actinidia*), and major export cut flower crops *Zantedeschia* and *Sandersonia*, were introduced to New Zealand by enthusiasts. Their establishment and initial screening for suitability to New Zealand conditions took place informally and at no great cost. In contrast, over three decades of planned introductions undertaken by the former Department of Scientific and Industrial Research were thrown away as a result of the establishment of Crown Research Institutes and their pseudo-commercial philosophy.

Currently border controls are so draconian that amateur enthusiasts cannot bring anything back from an overseas trip and are even denied the opportunity to participate in long established seed distribution schemes such as those run by the Royal Horticultural and Hardy Plant Societies in Britain. Many overseas seed companies will no longer supply catalogues to customers in New Zealand as the difficulties and costs involved in sending seed to New Zealand make it not economic.

## THE FUTURE

New Zealand is a very small and remote country. Because of our European heritage, a wealth of plant material has been brought here from around the world dating from the very earliest days of settlement. This has enabled us to be a player on the global stage. If we continue on the current course we will become an insignificant horticultural backwater. Regrettably, as things stand, I have to say to any young people wanting to breed plants — “New Zealand is no longer the place to do it.” Negatives are always difficult to recognise and with the long time lines involved it will probably be a quarter of a century or more before the next generation is left wondering why New Zealand has nothing new to offer world horticulture.

## How to Create a Strong Brand®

### Charlotte Henley

Kensington Swan, 89 The Terrace, PO Box 10 246, Wellington

### SELECTING A STRONG BRAND

A lot of thought should go into choosing a brand name, because some marks are stronger and therefore easier to protect and enforce than others. From a marketing perspective it is tempting to select a mark that is directly descriptive in some sense of the goods or services it is to be used in relation to (for example “Hastings Native Plant Nursery” for a native plant nursery in Hastings). From a trademark perspective however, it is difficult to obtain legal protection for a descriptive mark, as it is considered that any trader should fairly be able to use a mark that is descriptive of the goods or services in relation to which it is to be used. The exception to this is that it may be possible to obtain trademark protection for a descriptive mark where there has been substantial and prolonged use of the mark.

In comparison, a mark that is fanciful, completely made up or unrelated to the particular goods or services it is to be used in relation to, is much easier to obtain legal protection for, as it is considered to be inherently distinctive.

Examples of marks from weakest to strongest are as follows:

- 1) Wholly descriptive marks — very difficult to protect and enforce (e.g., Spray-n-Wipe™).
- 2) Somewhat descriptive marks — still likely to encounter difficulties (e.g., ConQuip™ for concrete equipment services).
- 3) Unrelated common words — e.g., Blackberry® for a handheld computer/phone, or Hurricanes® for a rugby team.
- 4) Completely fanciful — e.g., Kodak®, Adidas®.

So how do you choose?

Choosing a mark that is not directly descriptive of your goods or services may be slightly more challenging to start with. It may involve more marketing to establish a reputation in relation to the mark. Ultimately however it should result in a stronger brand that will in the long run be easier to protect and enforce.

### PROTECTING YOUR MARK

Once you’ve chosen a brand name you want to use, how do you go about protecting it? The best way to protect a brand is to register it as a trademark at the Intellectual Property Office of New Zealand (IPONZ). This involves filing a trademark application specifying the mark and the particular goods or services in relation to which you intend to use the mark.

IPONZ will then examine the application to ensure that:

- There are no other identical or confusingly similar marks already registered or applied for in relation to the same or similar goods or services; and
- The mark is distinctive in relation to the goods or services specified in the application.

Assuming IPONZ does not raise any objections on either of these grounds, an application will be accepted, and then advertised in the monthly IPONZ journal.



Provided no third party objects to its registration within a 3-month period following its advertisement, the application will proceed to registration.

Once registered the trade mark owner has the legal exclusive right to use the mark anywhere in New Zealand in relation to the goods or services specified in the registration. This right lasts for an initial period of 10 years, but can be extended indefinitely upon the payment of renewal fees every 10 years. If you do not register your trademark, you may still acquire legal rights to the mark through extensive use in trade that establishes a reputation and goodwill in the mark. If this occurs you may be able to take action under the tort of passing off or the provisions of the Fair Trading Act 1986 that prohibit deceptive or misleading conduct in trade.

The disadvantages of relying on unregistered (or common law) rights to your trademark are:

- They only arise in the specific geographical locations in New Zealand that you can prove you have established a reputation and goodwill; and
- It can take considerable time and cost to make sufficient use of a mark in trade to have established the necessary goodwill.

It is therefore often more difficult and costly to enforce unregistered versus registered trademark rights.

### **MARKETING YOUR BRAND**

Once you've chosen and registered your mark, you may want to market it to promote the goods or services you are offering. When doing so it is important that your mark is always used in a trademark sense, so that it does not become a generic term for your goods or services. If it does, then it may not be possible to enforce your rights in it.

The following guidelines should be followed for trademark use:

- Use the symbol ® in close connection to your trademark (usually to the top right of your mark) once you have obtained trademark registration. Prior to registration of your mark, you should use the ™ symbol.
- Display the trademark differently from surrounding text, for example in capitals, bold, italics, with quote marks, or with initial capital letters.
- Use the trademark as an adjective followed by the generic name for the goods/services.
- Do not use the trademark as a noun, verb, in the plural, or hyphenated.
- Do not use the trademark as a plant variety/cultivar name. Variety/cultivar names are by definition generic.

### **ENFORCING YOUR TRADE MARK**

If a third party makes use of your trade mark (or a mark which is confusingly similar to your trade mark) in relation to the same or similar goods or services to yours, it is important that you contact an intellectual property lawyer and determine if legal action can be taken. If you do not take action against the third party, the value and usefulness of your trade mark, may well decrease. It may also make it more difficult, if not impossible, to take action against a different infringer or the same infringer at a

later date if no action was taken in the first instance. Your lawyer will consider if you have legal grounds for taking action. If so, they will in the first instance contact the third party and ask that they “cease and desist” their apparent infringement of your trademark. Ideally the infringement will either cease absolutely or you reach some settlement acceptable to both parties. If this does not occur it may be necessary to take court action to obtain an injunction instructing the third party to stop infringement and, in some cases, to pay damages for their infringement.

### CONCLUSION

By selectively and knowledgeably choosing your brand and protecting it by registering it as a trade mark, then by appropriately marketing your brand and enforcing any infringement of it, you will build a strong and long-lasting brand of great value.

### ADDITIONAL READING

Intellectual Property Office of New Zealand <[www.iponz.govt.nz](http://www.iponz.govt.nz)>.

---

## The Effect of Gibberellic Acid, Potassium Nitrate, and Cold Stratification on the Germination of Goldenseal (*Hydrastis canadensis*) Seed<sup>®</sup>

J.M. Follett<sup>1</sup> and J.A. Douglas

New Zealand Institute for Crop & Food Research Ltd, Ruakura Research Centre, Private Bag 3123, Hamilton

R.A. Littler

Waikato Centre for Applied Statistics, University of Waikato, Private Bag 3105, Hamilton

A laboratory experiment was conducted to measure the effects of various factors on germinating goldenseal seed. Seeds were soaked in gibberellic acid (0.5 g·L<sup>-1</sup>, GA<sub>3</sub>) or potassium nitrate (2 g·L<sup>-1</sup>, KNO<sub>3</sub>) for 2, 6, 12, or 24 h, followed by periods of cold stratification at 4 °C (0, 2, 4, 8, or 12 weeks). GA<sub>3</sub> treatment accelerated the germination process with 61% of the seed germinating to the seed splitting stage in 47 days compared to 4% in the non-GA<sub>3</sub> treatments. Neither soak time nor osmotic conditioning with KNO<sub>3</sub> had any effect on germination. Cold temperature stratification at 4 °C had a negative effect on germination. Increasing the stratification time from 0 to 12 weeks induced secondary seed dormancy and reduced overall germination after 6 months incubation at 1 °C by 23% compared to fresh, untreated seed, which gave 80%–90% germination after 3 months. Germinating seed from all treatments was observed to be highly susceptible to disease under laboratory conditions suggesting this may also be a factor in the poor establishment of goldenseal crops in the field. The lack of seedling development following seed splitting suggests that the conditions, which favour the early germination process are different from those that promote seedling growth.

Keywords: Goldenseal, germination, gibberellic acid, stratification, Ranunculaceae, osmotic conditioning.

---

<sup>1</sup>Deceased

later date if no action was taken in the first instance. Your lawyer will consider if you have legal grounds for taking action. If so, they will in the first instance contact the third party and ask that they “cease and desist” their apparent infringement of your trademark. Ideally the infringement will either cease absolutely or you reach some settlement acceptable to both parties. If this does not occur it may be necessary to take court action to obtain an injunction instructing the third party to stop infringement and, in some cases, to pay damages for their infringement.

### CONCLUSION

By selectively and knowledgeably choosing your brand and protecting it by registering it as a trade mark, then by appropriately marketing your brand and enforcing any infringement of it, you will build a strong and long-lasting brand of great value.

### ADDITIONAL READING

Intellectual Property Office of New Zealand <[www.iponz.govt.nz](http://www.iponz.govt.nz)>.

---

## The Effect of Gibberellic Acid, Potassium Nitrate, and Cold Stratification on the Germination of Goldenseal (*Hydrastis canadensis*) Seed<sup>®</sup>

J.M. Follett<sup>1</sup> and J.A. Douglas

New Zealand Institute for Crop & Food Research Ltd, Ruakura Research Centre, Private Bag 3123, Hamilton

R.A. Littler

Waikato Centre for Applied Statistics, University of Waikato, Private Bag 3105, Hamilton

A laboratory experiment was conducted to measure the effects of various factors on germinating goldenseal seed. Seeds were soaked in gibberellic acid (0.5 g·L<sup>-1</sup>, GA<sub>3</sub>) or potassium nitrate (2 g·L<sup>-1</sup>, KNO<sub>3</sub>) for 2, 6, 12, or 24 h, followed by periods of cold stratification at 4 °C (0, 2, 4, 8, or 12 weeks). GA<sub>3</sub> treatment accelerated the germination process with 61% of the seed germinating to the seed splitting stage in 47 days compared to 4% in the non-GA<sub>3</sub> treatments. Neither soak time nor osmotic conditioning with KNO<sub>3</sub> had any effect on germination. Cold temperature stratification at 4 °C had a negative effect on germination. Increasing the stratification time from 0 to 12 weeks induced secondary seed dormancy and reduced overall germination after 6 months incubation at 1 °C by 23% compared to fresh, untreated seed, which gave 80%–90% germination after 3 months. Germinating seed from all treatments was observed to be highly susceptible to disease under laboratory conditions suggesting this may also be a factor in the poor establishment of goldenseal crops in the field. The lack of seedling development following seed splitting suggests that the conditions, which favour the early germination process are different from those that promote seedling growth.

Keywords: Goldenseal, germination, gibberellic acid, stratification, Ranunculaceae, osmotic conditioning.

---

<sup>1</sup>Deceased

## INTRODUCTION

Goldenseal (*Hydrastis canadensis* L., Ranunculaceae) is a highly valued North American medicinal herb which has traditionally been gathered from wild populations (Foster, 1993). To ensure its survival goldenseal was listed under the CITES Treaty (Convention on International Trade in Endangered Species) in 1997 (Bannerman, 1998). Research into the production of this species is now focused on developing sustainable cultivation methods (McGuffin, 1999).

Goldenseal can be propagated by division of the underground rhizome, root cuttings, and seed (Henkel and Klugh, 1908; Lloyd, 1912; van Fleet, 1914; Foster, 1993; Sturdivant and Blakley, 1999; Davis, 1999; Davis and McCoy, 2000) with propagation by seed considered to be the most difficult and unpredictable method (Sturdivant and Blakley, 1999; Davis, 1999; Davis and McCoy, 2000). As goldenseal seed is recalcitrant; seed for propagation is extracted from the ripe fruit pulp in summer and stored in moist sand until sowing (Henkel and Klugh, 1908; van Fleet, 1914; Hardacre, 1962; Davis and McCoy, 2000). Seed stored dry does not germinate (Deno, 1993). Hardacre (1962) successfully grew goldenseal from both autumn and spring sowings but generally found autumn sowing was more successful than spring sowing. Foster (1993) suggested goldenseal seed should be refrigerated for 3 months before sowing in spring, while Sturdivant and Blakley (1999) advocated leaving seed sown in trays outside until early spring to achieve winter chilling before bringing them into a greenhouse to germinate. Davis (1999) considered that the best seed germination was achieved by sowing fresh seed in the late summer-autumn period immediately after extraction. Experiments by Davis and McCoy (2000) found that where seed was stored in moist sand at 21 °C and sown in late autumn an average germination rate of 37% (range 25%–88%) was achieved the following spring. Seed, which was held at 21 °C for 30 days and subsequently at 4 °C, or held over the entire period at 4 °C, and planted the following spring, gave an average germination rate of 45% (range 30%–70%) but with the germination occurring two seasons later (Davis and McCoy, 2000).

Germination of genera within the family Ranunculaceae is often enhanced by pre-chilling, exposure to light, gibberellic acid ( $GA_3$ ), and osmotic conditioning with potassium nitrate ( $KNO_3$ ) (Ellis et al., 1985). Recent examples in the literature show that low temperature and  $GA_3$  promoted the germination of *Cimicifuga nanchuanensis* (Fu et al., 1998) and *Thalictrum aquilegifolium* (Sim et al., 1996), and  $KNO_3$  enhanced the germination of *Ranunculus sceleratus* (Shim et al., 1998). Foster (1993) has previously recommended prechilling goldenseal before sowing but no information could be found on the use of  $GA_3$  or  $KNO_3$  to aid the germination of goldenseal seed. The success of these exogenous chemical treatments in enhancing the germination of other Ranunculaceae genera raised the question of whether the germination of goldenseal could also be improved to give a consistently high rate. To investigate this, goldenseal seed was treated with  $GA_3$  or  $KNO_3$  and stratified at 4 °C before being placed under constant warm temperature incubation to measure the effects of the treatments on germination.

## MATERIALS AND METHODS

Ripe berries were collected in mid summer (February in New Zealand) from 5-year-old goldenseal plants grown outdoors under shade cloth in the Waikato, New Zealand (latitude 37° 50' S, longitude 175° 18' E). The berries were mashed in a sieve and the

seed was separated from the pulp under running water similar to method described by Davis and McCoy (2000). The extracted seed was surface sterilised by soaking it in a 0.3% sodium hypochlorite solution for 5 min and then air dried and weighed.

A factorial experiment combining 2 putative-dormancy-breaking agents ( $0.5 \cdot \text{L}^{-1} \text{GA}_3$  or  $2 \text{ g} \cdot \text{L}^{-1} \text{KNO}_3$ )  $\times$  4 soak times (2, 6, 12, 24 h)  $\times$  5 moist-seed stratification treatments at 4 °C (0, 2, 4, 8, 12 weeks) with the control treatments consisting of two replicates of the seed stratification treatments (0, 2, 4, 8, 12 weeks) after soaking in water was laid down on 13 March 1996 with one replicate. This design gave a total of 50 treatment units with each unit having ten seeds placed on moist filter paper in a covered Petri dish and kept constantly moist for the duration of the trial. Following the stratification treatments at 4 °C the Petri dishes were placed in a fluorescent lit incubation cabinet at 14 °C. Seed germination, indicated by the splitting of the hard seed coat, was recorded weekly for the next 264 days (180 days incubation after the longest stratification treatment). The germination counts recorded after 47, 89, 131, and 180 days incubation were used to analyse the results. After 180 days, all ungerminated seeds were dissected and assessed for seed viability by soaking them in a 1.0% tetrazolium solution for 6 h (Hartmann and Kester, 1975).

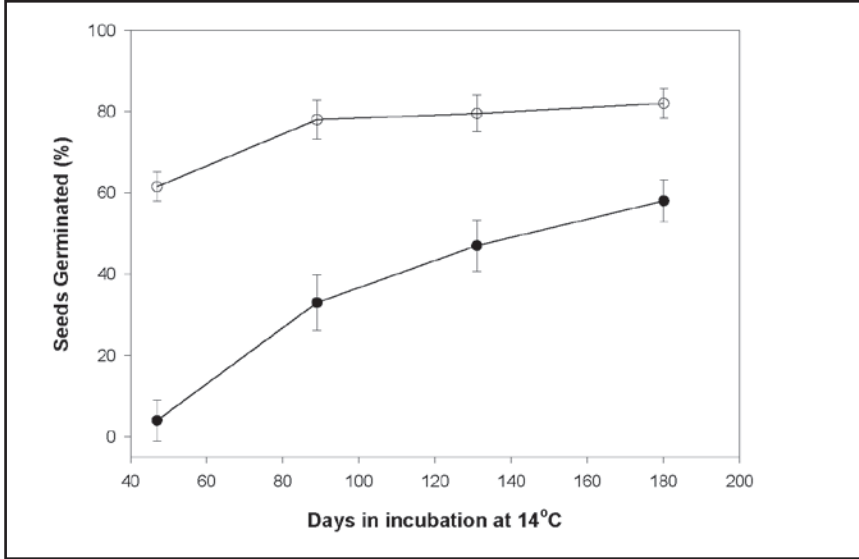
Analysis of variance was carried out on the seed germination counts after 47, 89, 131, and 180 days in 14 °C incubation using the inbuilt replication of the factorial design to assess the main effects and two-factor interactions. The precision of the main effect was further enhanced by combining treatments which did not differ statistically from each other.

## RESULTS

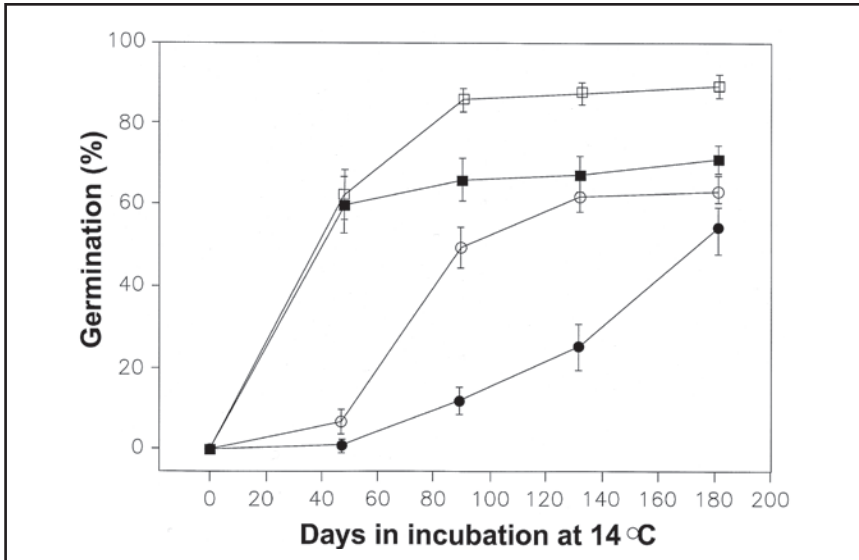
The fresh seed extracted from the berries had a mean seed weight of 1.33 g/100 seed (SD = 0.042) and after soaking for 24 h in either  $\text{GA}_3$  or  $\text{KNO}_3$  solutions had a seed weight of 1.50 g per 100 seeds (SD = 0.092). There was no effect on germination from varying the seed soaking time or soaking the seed in  $\text{KNO}_3$ . This data was subsequently pooled with the control treatments to increase the precision of the  $\text{GA}_3$  and the stratification effects.

Seed treated with  $\text{GA}_3$  when incubated at 14 °C began germinating after 19 days with 61% germinating after 47 days and 82% after 180 days. By comparison untreated seed or seed treated with  $\text{KNO}_3$  had 4% seed germinated after 47 days and 58% by 180 days (Fig. 1). Seed given a short stratification (0, 2, or 4 weeks) germinated more quickly than those given a long stratification (8 or 12 weeks) with the use of  $\text{GA}_3$  both speeding up the germination process and overcoming the stratification effect (Fig. 2). Seed soaked in  $\text{GA}_3$  gave similar germination counts in all stratification treatments following 47 days incubation, but the subsequent germination was 20% less in the longer stratification treatment. The short stratification treatments without  $\text{GA}_3$  had a similar but slower pattern of germination than the seed with  $\text{GA}_3$  treatments with germination continuing over a longer period and ending with a lower final germination (Fig. 2). The longer stratification treatment without  $\text{GA}_3$  showed an entirely different pattern of germination with low germination in the first 87 days and germination continuing over the entire 180 days (Fig. 2).

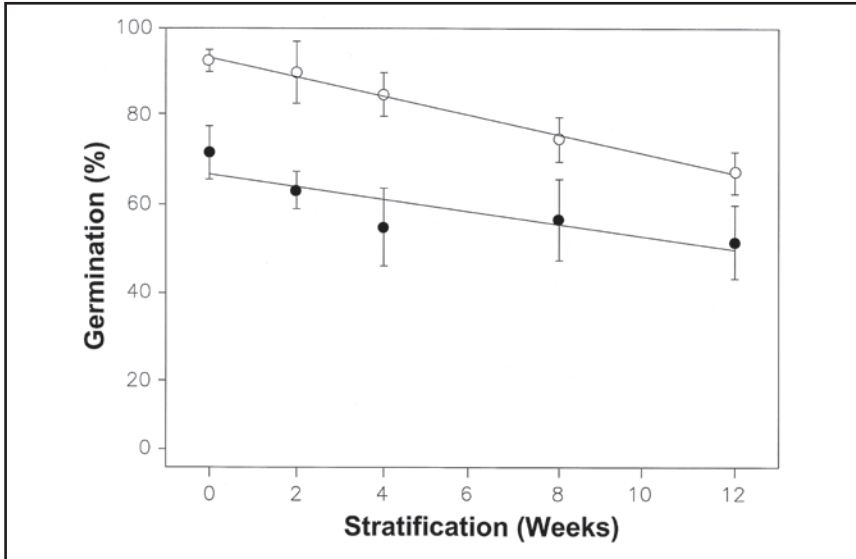
Regression analysis of the stratification treatments showed a significant linear effect on seed germination as stratification time increased (Fig. 3). Stratification of goldenseal seed for 12 weeks, reduced the overall germination by 23% from 81% to 58% compared to no stratification, with the effect being more pronounced for the



**Figure 1.** The main effect of soaking seed with (O) and without (●) GA<sub>3</sub> on germination when incubated at 14 °C.



**Figure 2.** The interaction between a short stratification period (0, 2 or 4 weeks) with (□) and without (O) GA<sub>3</sub> and a long stratification period (8 or 12 weeks) with (■) and without (●) GA<sub>3</sub> on seed germination. Error bars indicate the standard error of the treatment means.



**Figure 3.** Effect of stratification on the germination of seed soaked with (O) and without (●) GA<sub>3</sub> after 180 days incubation at 14°C. The regression equations are  $y = 93.32 - 2.18$  strat week, ( $R^2 = 0.99$ ) for the GA<sub>3</sub> treatment and  $y = 68.07 - 1.55$  strat week, ( $R^2 = 0.67$ ) for the KNO<sub>3</sub> and water treatment.

GA<sub>3</sub>-treated seed (93% to 68%) than for seed treated with KNO<sub>3</sub> or water (67% to 49%) (Fig. 3).

At the end of the experiment 13% of the KNO<sub>3</sub> and water-treated seed, and 2% of the GA<sub>3</sub>-treated seed, that had not germinated were viable but dormant when tested with tetrazolium. There were also more dormant seed left ungerminated in the 12-week stratification treatment (28%) than in the unstratified seed (7%) in the KNO<sub>3</sub> and water treatment. All treatments had a final germination potential of 80%–100% when the alive but dormant seed numbers were combined with the seed germination numbers.

## DISCUSSION

The propagation of goldenseal from seed is known to be difficult and unpredictable (Sturdivant and Blakley, 1999; Davis, 1999; Davis and McCoy, 2000). It is well known that goldenseal seed needs to be stored moist to maintain viability (Henkel and Klugh, 1908; van Fleet, 1914; Hardacre, 1962; Foster, 1993; Davis and McCoy, 2000) and, the increased seed dormancy after cold storage is one explanation for the variable and prolonged germination of spring-sown crops compared to autumn-seeded crops found by Hardacre (1962). More recent results have found that seed stored under warm (21 °C) rather than cold conditions has been beneficial to germination (Davis, 1999; Davis and McCoy, 2000). From our studies and those of Davis (1999), the most reliable germination of goldenseal seed is from fresh seed sown immediately. Treating seed with GA<sub>3</sub> had a significant positive impact on the rate of germination and in addition it gave the lowest number of ungerminated seeds



at the end of the experiment indicating it was effective in breaking seed dormancy as well as accelerating the germination. There was no benefit from prolonging the seed soaking in  $GA_3$  beyond 2 h although soaking for 24 h is recommended for most species (Hartmann and Kester, 1975).

Osmotic conditioning with  $2\text{ g}\cdot\text{L}^{-1}$   $KNO_3$  for 2 to 24 h had no effect on germination of goldenseal seed but it is unknown whether longer soak times of 2 to 21 days as recommended by Khan (1992) would be more effective.

Our experiment successfully germinated goldenseal seed to the seed cracking stage but the subsequent development of seedlings was very slow. Once the seed had cracked there was a high mortality from a number of diseases identified as *Alternaria alternata*, *Fusarium oxysporum*, *F. proliferatum*, *F. sacchari*, and *Mucor* species. In spite of the disease deprivation the slowness of the seedling growth suggests that seedling development in goldenseal is either hampered by a secondary dormancy or else the environmental requirements for seedling development are markedly different than those for the germination process. This aspect of growing goldenseal from seed is the subject of further research.

**Acknowledgements.** We thank Jane Andrew, Waikato Centre for Applied Statistics, Waikato University, Hamilton, for assistance with the statistical analyses.

#### LITERATURE CITED

- Bannerman, J.E.** 1998. Goldenseal in world trade: Pressures and potentials. *HerbalGram* 41:51–52.
- Davis, J.M.** 1999. Forest production of goldenseal. *Agroforestry Notes*, USDA Forest Service, July 1999.
- Davis, J.M.** and **J. McCoy.** 2000. Commercial goldenseal cultivation. North Carolina State University Horticulture Information Leaflet 131.
- Deno, N.C.** 1993. Seed germination theory and practice. N.C. Deno, private publication, 139 Lenor Drive, State College, Pennsylvania.
- Ellis, R.H., T.D. Hong,** and **E.H. Roberts.** 1985. Handbook of seed technology for genebanks. Volume II. Compendium of specific germination information and test recommendations. Handbooks for Genebanks No 3, International Board for Plant Genetic Resources, Rome, Italy.
- Foster, S.** 1993. Herbal renaissance: Growing, using and understanding herbs in the modern world. Gibbs-Smith, Salt Lake City, Utah.
- Fu, J., W. Qi, Z. Gu,** and **R. You.** 1998. Seed dormancy and germination in *Cimicifuga nanchuanensis*. *Acta Botanica Sinica*. 40(4):303–308.
- Hardacre, J.V.** 1962. The wildcrafters goldenseal manual, Laurence Barcus, Rockville, Indiana, USA:1–11.
- Hartmann, H. T.** and **D.A. Kester.** 1975. Plant propagation principles and practices. Prentice-Hall, Inc., Englewood Cliffs, New Jersey.
- Henkel, A.** and **G.F. Klugh.** 1908. The cultivation and handling of goldenseal. U.S. Dept. Agric., Bureau of Plant Industry Circular No. 6.
- Khan, A.A.** 1992. Preplant physiological seed conditioning. *Hort. Review* 132, 131–181.
- Lloyd, J.U.** 1912. The cultivation of *Hydrastis*. *J. Amer. Pharmaceutical Assoc.* 1:5–12.
- McGuffin, M.** 1999. AHPA Goldenseal survey measures increased agricultural production. *HerbalGram* 46:66–67.
- Shim, S.J., S.G. Lee,** and **B.H. Kang.** 1998. Effects of several chemicals and burial of seeds into the soil on dormancy breaking of weed species. *Korean J. Weed Sci.* 18(4):295–303.
- Sim, Y.G., Y.Y. Han, I.K. Song, T.Y. Kwon, J.S. Jung, J.T. Yoon,** and **B.S. Choi.** 1996. Influence of  $GA_3$  and chilling treatment on seed germination in several native plants. *Rural Development Admin. J. Agric. Sci. (Horticulture)* 38(1):700–704.
- Sturdivant, L.** and **T. Blakley.** 1999. The Bootstrap Guide to medicinal herbs in the garden, field and marketplace. San Juan Naturals, Friday Harbor, USA.
- van Fleet, W.** 1914. Goldenseal under cultivation. U.S. Dept Agric. *Farmers Bull.* 613.

## Using Tissue Culture to Help Develop New Crops®

**P.J. Fletcher and J.D. Fletcher**

New Zealand Institute for Crop & Food Research Limited, Private Bag 4704, Christchurch

**J.M. Follett<sup>1</sup>**

New Zealand Institute for Crop & Food Research Limited, Ruakura Research Centre, Hamilton

### INTRODUCTION

Crops, new to New Zealand, are imported for a number of reasons. They might be considered to have market potential or the ability to grow in areas where other crops struggle. Importation might also expand the range of germplasm available for plant selection. Any crop imported into New Zealand is scrutinised and regulated by Biosecurity New Zealand since its health status may be unknown. It is held in a closed quarantine facility where it undergoes rigorous pathogen testing. Frequently, the plant material is found to be infected with one or many viruses that must be eliminated before the crop can be released and research and development studies commence. This paper describes an effective and efficient *in vitro* system that eliminates viruses in vegetatively propagated species. The system involves heat and chemical therapies. Five successfully treated species are described. Three of these are Andean root crops that are of culinary interest: oca (*Oxalis tuberosa*), ulluco (*Ullucus tuberosus*), and arracacha (*Arracacia xanthorrhiza*). Two other species, imported from Japan, are of both culinary and medicinal interest: mountain yam (*Dioscorea opposita*) and edible lily (*Lilium lancefolium*). In addition to applying tissue culture techniques to eliminating viruses, the processes of micropropagation and germplasm storage are also described.

### METHOD

#### What Crops and Why Have They Been Imported?

**Oca**, grown and sold here as New Zealand yam, is an old and well established crop. In 1993, new accessions were imported by Alfredo Grau to expand this germplasm base (Grau and Halloy, 1994). It has high nutritional and culinary value (Martin et al., 2004). Oca is usually propagated by planting whole tubers (Popenoe et al., 1989).

**Ulluco** is a colourful and attractive new root crop that has been imported to extend the range of vegetables available to growers, producers, and consumers. It is usually propagated by planting small tubers (Popenoe et al., 1989).

**Arracacha** produces lateral roots, arising from the crown of the root, which resemble parsnip roots. They are tender and delicately flavoured and are another interesting choice of new crop. It is usually propagated with offsets or shoots that are produced on the crown of the main rootstock (Popenoe et al., 1989).

These three crops grow at high altitudes in the Andes in Argentina, Peru, and Bolivia. Along with potato, with which they are often interplanted, they were the main staple diet of the Incas and are an important part of the diet of Andean inhabitants today.

---

<sup>1</sup>Deceased

**Mountain yam** is a culinary crop from Japan where it is peeled and cooked by any of the methods used for potatoes. In addition to its culinary value, it contains a range of phytochemicals and is documented to have medicinal attributes. Bensky and Gamble (1986) claim that it tonifies and augments the spleen and stomach; tonifies the lung qi and augments the lung yin; tonifies and stabilizes and binds the kidneys. Traditionally, mountain yam is propagated by cuttings or by planting small, whole, young tubers (Larkcom, 1991).

**Edible lily** has been grown as a food source in Japan and China since around the 17<sup>th</sup> century. The protein content of lily bulbs is twice that of potatoes. Medicinally, its active ingredient is lilioside, which is said to moisten the lungs, clear the heart, and calm the spirits (Bensky and Gamble, 1986). Edible lily bulbs are propagated using stem bulbils (Philips and Rix, 1993).

**Virus Testing and Detection.** Viruses were identified using electron microscopy, enzyme-linked immunosorbent assay (ELISA), herbaceous indicator hosts, and PCR analysis. Viruses detected in the Andean crops were: arracacha A virus, arracacha B virus, arracacha latent virus, papaya mosaic virus, ullucus virus C, ullucus mild mottle virus, ullucus mosaic virus (Fletcher and Fletcher, 2001). Viruses detected in mountain yam were cucumber mosaic virus and lily symptomless virus. Viruses detected in edible lily were dioscorea latent virus and an unidentified poty-virus.

**Tissue Culture and Virus Elimination.** The tubers of oca, ulluco, and mountain yam, the root of arracacha, and the bulb of edible lily were planted in sterile soil in the quarantine glasshouse. Plants were grown at 18 to 24 °C without supplementary lighting. The first step in establishing the plants in tissue culture was to select a suitable explant: stem nodal section (oca and ulluco); crown offshoot (arracacha); developing adventitious stem shoot (mountain yam); and bulb scale (edible lily). The explants were surface sterilized in a 1% (a.i.) sodium-hypochlorite solution for 20 min and then rinsed three times with sterile, distilled water.

Aseptically, the explants were placed in pottles on Murashige and Skoog (1962) tissue culture medium that had been modified by the addition of the anti-viral chemical ribavirin (a synthetic riboside, 1-b-D-ribofuranosyl-1,2,4-triazole-3-carboxamide, Virazole<sup>TM</sup>. John Bell and Croyden, 51-54 Wigmore Street, London, United Kingdom) at a concentration of 50 mg·L<sup>-1</sup>; providing the chemical component of the process. The pottles were placed in a growth cabinet set for alternating periods of 4 h light at 35 °C and 4 h dark at 31 °C; providing the heat treatment component of the process.

When the lateral or apical shoots (depending on the species) were approximately 1 cm long, they were excised and inoculated on to the same growth medium without ribavirin. They were grown for approximately 1 month in normal tissue culture conditions of 24 °C under fluorescent lights with a 16-h photoperiod and 8 h dark. The tissue-cultured plantlets were then tested for viruses. Those that tested virus-free were to be released from quarantine, ready for further research and development. The process would be repeated for plantlets that tested positive for virus.

**The Micropropagation and Germplasm Storage Processes.** These processes are applied to pathogen-free, tissue-cultured material where the plant is either micropropagated or is stored as in vitro germplasm that can be sourced at a future time. Micropropagation is the process used by tissue culturists to build up plant-

let numbers. Firstly, suitable growing points are excised. These may be shoot apical sectors, stem nodal sectors or, as with mountain yam, developing adventitious stem shoots. These are transferred to pottles containing appropriate tissue culture medium, which are then placed in a growth cabinet. After 4 to 6 weeks of growing under normal tissue culture conditions, healthy plantlets are ready for further micropropagation or for exflasking into a mist bed and then into the glasshouse. Germplasm storage retains the plantlets in tissue culture. Germplasm is maintained by subculturing and, for many species, the growing conditions are modified; e.g., cooler growing conditions, less light, and/or altered medium composition.

## CONCLUSION

Tissue culture plays an important and useful role in new crop research and development by providing:

- An efficient and effective tool for virus elimination;
- A method for rapid multiplication of the new crop;
- In vitro, long-term storage of germplasm;
- A cost-efficient process for testing and establishing new crops in New Zealand agriculture.

## LITERATURE CITED

- Bensky, D.** and **A. Gamble.** 1986. Chinese herbal medicine, *Materia Medica*. Eastland Press, Seattle, Washington.
- Fletcher, P.J., J.D. Fletcher,** and **S.L. Lewthwaite.** 1998. In vitro elimination of onion yellow dwarf and shallot latent viruses in shallots (*Allium cepa* var. *ascalonium* L.). *N.Z. J. Crop Hort. Sci.* 26: 23–26.
- Fletcher, P.J.** and **J.D. Fletcher.** 2001. In vitro virus elimination in three Andean root crops: Oca (*Oxalis tuberosa*), ulluco (*Ullucus tuberosus*) and arracacha (*Arracacia xanthorrhiza*). *N.Z. J. Crop Hort. Sci.* 29:23–27.
- Larkcom, J.** 1991. *Oriental Vegetables*. Kodansha International, Tokyo.
- Grau, A.** and **S. Halloy.** 1994. Feast or famine. *Growing Today*, June 1994: 28–33.
- Martin, R.J., G.P. Savage, B. Deo, S.R.P. Halloy,** and **P.J. Fletcher.** 2005. Development of new oca lines in New Zealand. *Proceedings of the first international symposium on root and tuber crops: Food down under*. *Acta hort.* 670:87–92.
- Murashige, T.** and **F. Skoog.** 1962. A revised medium for rapid growth and bioassays with tobacco tissue cultures. *Physiol. Plantarum* 15:473–497.
- Phillips, R.** and **M. Rix.** 1993. *Vegetables*. Pan Books Ltd, London.
- Popenoe, H., S.R. King, J. Leon,** and **L.S. Kalinowski.** 1989. *Lost crops of the Andes*. National Academy Press, Washington D.C.

## Showcasing New Zealand Native Plants at Chelsea Flower Show<sup>®</sup>

**Trish Waugh**

Landscape Design Co Ltd., R.D. 1, Katikati

### INTRODUCTION

Ten years ago our company did a planning session with our business coach to determine our mission statement and vision for our business. Our vision was "to create New Zealand-style gardens and take them to the world," a heady task at the time. However, when the Ellerslie Flower Show initially approached us in 2001 to do just that we didn't hesitate to rise to the challenge. Our original team comprised Kim Jarrett, Tina Hart, Doug, and myself. Kim Jarrett is an art director in the film industry and landscape designer, my husband Doug a landscape manager, Tina Hart a scenic artist and realiser, and myself a landscape designer. We were missing something, however, and it was not until Doug and I heard Lyonel Grant speak at a Landscape Industries Association conference in Rotorua we knew what it was. Lyonel, a Maori master carver and multimedia sculptor who spoke with such passion, eloquence, and mana we knew instantly he was the next person to have on the team. The missing link in our design was the cultural element. We knew in our hearts right away Lyonel was our man. We approached him after his talk and suggested we meet in a few weeks time to talk over the Chelsea Project as we were starting to call it. Under the sponsorship of the Ellerslie Flower Show the first design for Chelsea evolved with Kim, Lyonel, and myself putting together a grand design, which covered nearly 250 m<sup>2</sup>. This design was presented to the Royal Horticultural Society in August 2001 for approval for the 2002 show. The design was accepted and a site allocated to us.

However, world events overtook us with the terrorist attacks on the twin towers and our nervous sponsor decided to withdraw from the project. In retrospect it was just as well that the project at this stage was canned. We had the biggest site at Chelsea that year and without question the least amount of money. Our design was extremely ambitious, far more so than the final garden we were to build. We were totally under-resourced and we more than likely would not have achieved anything near the success we did. A change in leadership and direction at the Ellerslie Flower Show saw them withdraw from the project. Luckily Tourism New Zealand, who had been waiting in the wings stepped in and decided to underwrite the project. It fit in with their marketing strategy. Their target demographic was the same as Chelsea Flower Show and there is a growing market for New Zealand garden tours for international visitors. This project was perfect for their marketing strategy but they were entering into the realms of the unknown. They had never done anything like this before and they did not know who we were, and no one had ever gone to Chelsea from this far away before. It was a huge risk for them that they took on with much enthusiasm. Basically Tourism New Zealand saved the project and the team will always be grateful to them for that. It was at this time Brian Massey joined the team. It was obvious to us all we were going to need extra help building the exhibit. Brian had just completed a project as head greens man on the Lord of the Rings movies and was very experienced with creating natural settings. Brian also was to help Lyonel create the two carvings that were featured in our design.

## THE DESIGN

The theme of the garden was to be one of well-being and guardianship — the health and spiritual well-being provided by the land and all it provides. It was a slice of New Zealand from the central plateau of the North Island out to the Chatham Islands. It encompassed elements of Maoridom and indigenous flora and geology that could only be 100% Pure New Zealand. And so “Ora The Garden of Well Being” was conceived. Taken from the word Kia ora meaning “be well.” The garden was inspired by mythical Maori fairies, the Patupaiarehe. These spirits are believed to live under the cover of mist. They are the gardeners and guardians of our native forests and we wanted the garden to be distinctly Aotearoa New Zealand. Much Maori symbolism and lore was incorporated into the design. The essence of kaitiakitanga or guardianship was very important to the garden and as a result we went to great lengths to ensure the cultural correctness of our design. We believed if we got this bit right we would get the rest right as well. Other cultural elements were incorporated into the design, a hui marae (traditional meeting place), moko waiwera (benevolent lizard form) carrying hot water from the Puna (spring) cooling it so the visitor to the garden could bath in the Nga Wha hot mineral pool. A cave or te waha o ruamoko was the dwelling place of the spirits of the garden. The ruamoko was to be the control center for all the special effects Kim had planned for the garden. Sound track birdcalls and the sound of traditional Maori instruments as well as housing pumps, water heaters, ultraviolet filters, smoke machines, and compressors.

## THE SEARCH FOR NEW ZEALAND PLANTS FOR CHELSEA

It was my responsibility to design and source the plants for the garden, to liaise with nurseries to have these plants grown on, arrange delivery to the site, and to place the plants. The planting design was based on a slice of New Zealand from the Rotorua area of the central North Island out to the Chatham Islands. We studied as many Chelsea gardens as possible to figure out a point of difference to English-style gardens and made the decision to use mainly lush, green-foliaged plants, ferns, and palms most typical of our northern and outer island coastal regions. It was important to select plants that fit the design brief. As many as possible had to be traditional medicinal plants or edible. They also had to be plants that would normally be found in the areas of New Zealand that our garden was a slice of. The plants also had to have a horticultural relationship with each other. We were well aware that many of these plants are frost tender so we included some species that fitted within our theme but were also hardier to the English climate. Our first step was to log on to the Royal Horticultural Society plant finder website which is a huge resource of information. We researched for plants on the internet and spent many late nights making phone calls and sending faxes to source the more than 1000 plants that fulfilled our design brief. Generally we were surprised at the extensive range of New Zealand native plants available in the United Kingdom. Many species were grown in small specialist nurseries so it took some time to narrow down the key nurseries. We found the largest quantities of the plants we were after in the more temperate southwest of England where the climate is warmer. Nurseries such as Trevena Cross, Hardy Exotics, and Burncoose. London also proved to have some of the softer species especially tree ferns, as there tends to be a warmer microclimate there brought about by the huge generation of heat from the city. Another determining factor was being able to contact these nurseries readily. Faxed communications

tended to be preferred by many nurseries but I found that I tended to favour the nurseries with more up-to-date communication systems. Sometimes it would take several weeks to get a response. One nursery when we emailed our wish list of plants replied "in your dreams." As it turned out they were to supply us with the most extensive range of plants. After exhaustive crosschecking we came up with a shortlist of United Kingdom nurseries, including one in Ireland that could supply us with about 1000 plants.

We then worked out the balance of the plants that we wanted to send from New Zealand, about 300 in total. Every possible lead was followed up in New Zealand. We were given many contacts by Mark Dean, Paul Turner, David King, and Gil Ellis. We called on plant brokers Ayley Horticulture based in Essex and I liaised with Mark Sylvester there. It was Mark who negotiated for a garden center north of Brighton to grow on the plants we were planning to export from New Zealand. South Downs Nurseries in West Sussex offered to care for and grow on the selection of plants we wanted to send from New Zealand. We especially wanted to use a proportion of plants that weren't available in England, so among other things we sent *Tecomanthe speciosa*, *Gunnera prorepens* (syn. *G. repens*), rimu (*Dacrydium cupressinum*), titoki (*Alectryon excelsus*), *Corokia* 'Silver Ghost', *Elatostema* 'Parataniwha', *Metrosideros* 'Red Carpet', *Machaerena sinclairii*, *Astelia* 'Alpine Ruby', *Xeronema callistemon*, *Macropiper melchior*, *Carex trifida*, and *Dracophyllum*. I had designed the planting to use as many potentially flowering or seeding plants as possible as one of the rules at Chelsea states that all plants used in the display are to be in flower. I thought long and hard about how to force some plants to flower out of season. Many Chelsea exhibitors have long established relationships with some of the larger growers such as Notcutts who artificially force plants on. However, I couldn't find anyone who was prepared to force New Zealand natives, as they were such an unknown. I reasoned that since flowering is triggered by day length, if I could get our spring-flowering New Zealand-grown plants over to the United Kingdom by the United Kingdom autumn (New Zealand spring) prior to the show we should trick the plants into flowering twice in six months. One of the import regulations into United Kingdom is that no plants shall have any flower buds or seed heads present so we had to reluctantly strip the *Gunnera prorepens* among other things of its beautiful berries. It was a gamble and responsible for many sleepless nights on my part. We sent the plants in two shipments one in November 2003 and the other in January 2004. It was then a matter of establishing an on-going relationship with the nurseries to ensure that they cared well for our plants over the next 6 to 8 months. In November 2003 I set off to England to visit all of these nurseries and scout around for extras, to establish what the quality of the plants was like, and to establish some sort of relationship with the people we were dealing with. It was my first visit to England and I visited many nurseries from the London area to Southwest Cornwall, from high-tech well presented nurseries such as Tendercare in Essex where one 40-cm *Hebe* can cost £36.00 to small back yard operations such as County Park, where untold treasures were to be found. I was surprised at the range of New Zealand natives available but disappointed at the quality. The English climate is not only cold but also very damp and it takes its toll on some of our more sun-loving species. The short day length and winter snows necessitate growing of plants in huge artificially lit tunnel houses. For example no *Phormium cookianum*, mountain flax, or hybrids were to be found in England, as it was just



too wet and cool. *Phormium tenax* hybrids do much better in this climate. At South Downs Nursery, where our recent imports were housed, we were lucky many could be grown on in a naturally lit glasshouse as the artificial lights tended to slightly etiolate and dull the foliage. I unfortunately had to cut the *Euphorbia glauca* back hard as it had etiolated badly in the 5 to 6 days in transit, as had the Chatham Island forget me nots (*Myosotidium hortensia*). On average the plants we sent over by air cost us \$NZ60.00 each, so every plant was very precious.

*Cordyline australis*, also known as Torbay palm in England, does exceptionally well and is not stripped by the insects we get in New Zealand. We sourced one key specimen for the forefront of the garden for a princely sum of £750.00 and no discount, not even for Kiwis a long way from home. A palm specialist in London proved very helpful (The Palm Centre), Toby Shobrook. They import a lot of tree ferns from New Zealand although they find the Australian *Dicksonia antarctica* to be the hardiest, with *D. fibrosa* and *D. squarrosa* the hardiest of the New Zealand tree ferns. The *Cyathea* species however don't respond well to the damp cold in England, and the same applies to many of our ground ferns. The best finds were to be had in south Cornwall. Trevena Cross is a nursery that specialises in South African, Australian, and New Zealand plants. I found many unexpected things there such as *Scleranthus*, southern beech (*Nothofagus*), and many ground ferns such as *Blechnum*, *Asplenium*, and *Polystichum*, they had ponga (*Cyathea dealbata*) trunks with self-seeded ferns and a lot of the detail plants needed in a display such as this. The *Scleranthus* was grown in a shaded tunnel house and was badly etiolated so I arranged for it to be shifted. The second find was a nursery at Penzance called Hardy Exotics. This is owned by an eccentric ex-shoe designer who has a passion for exotic plants. His three huge glasshouses are crammed with plants in varying stages of maturity and it was like walking into a jungle, but among other things he had enormous *Astelia*, flaxes (*Phormium*), *Cordyline* 'Green Goddess', nikau (*Rhopalostylis sapida*), puka (*Meryta sinclairii*), and many *Pseudopanax lessonii* hybrids that I hadn't seen before. On my return home I had mixed feelings about our plant selection but this was to prove unfounded in the end.

Doug and I set off in late April a week earlier than the rest of the team as we needed to check on the plants we had ordered, look around for anything new, and check on the plants we had sent over. Although there were plenty of plants to choose from they had gone through a very tough winter and were not in good condition. There had been heavy snow falls in Cornwall and Devon and plants such as ren-garenga lilies (*Arthropodium*), puka (*Meryta sinclairii*), and Chatham Island forget me nots (*Myosotidium hortensia*) had been damaged even in tunnel houses. Plants that seemed to thrive in the climate included *Cordyline indivisa* and *Astelia* cultivars 'Westland' and 'Alpine Ruby'. We realized we really had our work cut out for us and there would be quite a lot of grooming to do. The day after everyone else arrived we were all assembled at Clanden House at Guilford. This is the ancestral home of Lord Onslow, once governor of New Zealand. When in New Zealand he purchased a meeting house wharenui, which had survived the Mt. Tarawera volcanic eruption, and had taken it to his English estate and reassembled it as a boat shed. During the Second World War the estate was used as a hospital for convalescing soldiers. Two Maori soldiers saw the boat shed and realized what it was. They knew people had sheltered in this house to survive the eruption. They got permission to relocate the wharenui and restore it in this very Jacobian garden. Here Ngati Ranana, one of

the Iwi (tribal group) present in London, gave us a formal welcome. We then went to the Chelsea site for a blessing and cleansing of the area and a small piece of Aotearoa New Zealand had arrived at Chelsea. Now we had expected something like a nice grassy slope and a warm sunny day, but the Royal Horticultural Society had stripped off all the grass and left us with this very muddy site we were to wallow around in for the next few weeks. The rest of the team was jet lagged but I think all of us were wondering what lay ahead. More sheds were to be moved onto the site, including a British Broadcasting Corporation outside broadcasting semi trailer, but we did not know this for another 2 weeks. Looking at the Chelsea site plan shows how very crammed in everyone is. Our site was next to the main entry but due to there being a one-way system for vehicles we were right at the end of the system for delivery of plants and materials.

### **BUILDING THE DESIGN**

Day 1 of build up it was raining again and we were up to our ankles in mud, but do remember the Patupaiarehe like it when it is wet and misty. In fact it didn't just rain, it hailed and was freezing cold with thunder and lightning. We also had our first delivery of the large *Cordyline australis*, in fact this was the first plant on site at Chelsea for 2004. The next day and still it rained, however we dug the hole for the spa pool. Patupaiarehe liking it or not we were ready for it to stop raining. Digging holes was the worst part with 82 years of accumulated Chelsea gardens buried and just waiting to be dug up: rocks, bricks, stones, concrete, you name it we dug it up. About 4 days later, it had finally stopped raining. The cabbage tree was settling in, the silica terraces were in place on the liner, and the rock structures were going in with the cave being built behind. I think the reason it stopped raining was because we had built the cave and the Patupaiarehe had somewhere else they could hide. Day 6 and the spa pool was in and we were starting to lay out the paving. Lyonel designed the paving in a patiki design with hinuera stone; some natural and some oven baked which created a very three-dimensional effect.

The Australians were also there, sponsored by Fleming's Nurseries who grow 5 million units per year; it was designed by Jim Fogherty and built by Marty Semkin and his crew. They were a good fun team and they were well researched, having had done a reconnaissance the year before during the build up and the show. They had selected a site that had easy access, was not too crowded and they were able to have a container on site for a week or more. They impressed us as being very professional and a well-oiled machine.

While all of this was going on I had to contend with plants being delivered and not having anywhere to put them. We had deliveries coming in every day and we had to ensure everything was watered. The water proved to have a deposit in it so we had to laboriously wipe each leaf of the larger leaved species with soft cloths. We were also foliar feeding plants as many were quite yellow from the harsh winter, not like the rich greens we are used to. Some plants just didn't come through, such as the *Jovellana*, which showed no sign of flowering, and the *Clianthus* was well past flowering, which in England occurs in winter, as does the Kowhai (*Sophora*). The plants sent from Hardy Exotics in Penzance were a sorry looking lot and I could see a lot of the other exhibitors looking at us pityingly. Undaunted I set about removing all the diseased and frost-damaged foliage. There are many tricks of the trade and we were not above painting leaves green to cover blemishes. One of the worst was

a purple cabbage tree (*Cordyline*) from Burncoose Nursery in Devon. The owner Charles Williams had been very hospitable on our two visits, entertaining us in his centuries-old stone manor. He was well experienced in shows and when his selection of show-grade plants turned up I thought he was taking the micky. The purple cabbage tree was so motley and spotted but it did have an extraordinary flower about to open. We trimmed and trimmed for hours reshaping the leaves so that the brown edges and yellow spots were removed. This plant proved to be a showstopper. We were very fortunate to have a crew of Kiwis who turned up to help including Dan King and partner Marie who had a lot of experience working on film sets including *Lord of the Rings*. Also Teena Petit and Pam Russ who both came over from New Zealand especially to help out. Lyonel's wife Vicki Grant put in a huge amount of work on and off the site.

**Te Ihi.** When the carved ponga arrived their fronds were not in good enough condition to exhibit at Chelsea which was a bit of a break down for the team but we were determined to use them. We had put so much into them and getting them here we were not prepared to give up on them. We decided to work late that night and have the problem solved and the ihi looking sharp before we went home. It had been a major worry for us and we felt we couldn't go on with out having the problem solved. Ponga pieces went in and out; new ones went in and were spliced, to join alongside the carved ones. A few extra touches were made to the carving and a few hours later we had some compositions we were really happy with as we snuggled them up to the scenic. During the last few days of the build up the Tourism New Zealand public relations machine kicked in. Sloane Square Tube station was decked out with posters saying "New Zealand now growing in the United Kingdom" and the New Zealand native plants put in during the week of the show looked great. When we saw the London double-decker buses with the New Zealand publicity splashed all over them we really felt like we had arrived. Tina had to do the touch ups to the scenic and then we had to bring it into the garden using the plant material we had. The scenic was a representation of Mt. Tarawera and Lake Rotomahana where the pink and white terraces once existed. Three days out we looked as though we were cutting it a bit fine but felt it was completely manageable, until the film crews started appearing on the scene. We spent the next 3 days working around each other. The other thing we had to contend with was the guys in the orange vests, the Stewards. They were there for safety reasons, armed with megaphone loud hailers and they yelled at people every time a vehicle approached "watch your backs!!!" "Stand to one side!!!" During the show they would yell at the visitors "move along," like herding cattle. Security in general was extreme and we needed a pass for everything. The TV cameras were everywhere and in particular at the New Zealand exhibit. While it was quite nice to have the attention it was very frustrating, as we always had to stop work or work out of shot.

## COMPLETION AND CONCLUSION

Completely unannounced and without even so much as a "how do you do," four judges walked onto the garden taking us all by surprise. This was the preliminary judging and stern, poker-faced they sat down with our technical brief. They were giving nothing away and would make recommendations to the rest of the judges later that day. The next day the final judging took place with the same protocol. These guys have a bit to learn about garden-side manner. Luckily we were onto it and

finished with a small amount of time to spare. Only one other exhibitor has won gold first time up at Chelsea, made even more remarkable by the fact our team had traveled 20,000 km to do it. Our exhibit cost £100,000 to construct where the Sheik who won best of show spent £1,000,000. Two doors down were boasting £280,000 but only a silver award. All up there was approximately £60,000,000 spent on exhibits at Chelsea that year. Four Golds were awarded in our category and with New Zealand being one of them. It felt pretty damn good, and we beat the Aussies.

The garden had exceeded everyone's expectations and we had achieved what we thought was the impossible. New Zealand had not received so much TV publicity in the United Kingdom since the Americas Cup. Coupled with the success of Lord of the Rings and Whale Rider movies we were on a roll.

Winning Gold was great but the best part was the overwhelming appreciation we received from the public. Ex pat kiwis felt home sick, the Canterbury garden group was the first on the scene and they cheered, the British public was genuinely overwhelmed by the uniqueness of the garden. People queued for up to 1½ h to see the garden. We have no doubt that we were different at Chelsea. They had never seen anything like this before and we are sure this originality was what gave us the edge. There were many lessons to be learnt from this experience. One in particular was to do guardianship or kaitiakitanga and respect for our flora. Our flora is a priceless treasure that deserves our respect. I felt very privileged to be able to present such a wealth of unique flora to so many gardening enthusiasts. We are in an enviable position in New Zealand in that we have such a large number of indigenous plants not found anywhere else in the world. When these plants are used in a way that is sensitive to their natural habitats and associations they resonate. We created a sense of place in the heart of London that could only be Aotearoa New Zealand. At Chelsea they glowed and as we had linked them inextricably with our geology and our indigenous culture, the English public couldn't help but be touched. It was by far the most visited garden at the show and I am convinced it was because of the spirit or wairua with which we created it. It says it all Turangawaewaea a place to be, a place to call home. Lyonel wrote a small piece in our technical brief that always springs to mind:

“He toi whakairo

He mana Tangata”

“From artistic excellence

Comes human dignity”

For the team this garden was a celebration of who we are as a people. A journey that transcends culture, the land, and all it has to offer. It was a journey that touched millions of people and we are all very grateful and proud to have been part of it. We are a country that has only had significant populations of man for 500 years. We have done a lot of damage in that time, but we still have the most unique culture, geography, and plants in the world. We have a landscape and a culture that are intertwined. It is the essence of who we are as a people and that deserves celebrating, but it also deserves looking after. The world is changing at an ever-increasing pace and conservation now is about managing that change. I will leave you with one last thought; it is something that we said to ourselves when things got really tough. “We are all in the same waka (canoe); we just need to paddle in the same direction.”

## Making the Most Out of What You Grow — A Client's Perspective<sup>©</sup>

**Roger Milne**

Milne's Plant Link Ltd, 6 Polaris Place, East Tamaki, Auckland

### INTRODUCTION

Milne's Plant Link is a plant supply company that puts together list of plants for the landscape industry and for the major plant users. We are very focused on what we do and do not get involved in design, planting, or growing. We just supply plants. There are four staff pricing and selling, an excellent backup person in administration and the support staff for inwards goods and dispatch. We have a depot in East Tamaki, Auckland, where much of the product is delivered to and dispatched from. Clients come to us for several reasons, a major one being quality. Our clients' expectations are high, so please ensure that any plants you despatch to us are of the best quality available. We are in an age when information technology is the prime importance, so communication by email is increasingly significant. We welcome emailed trade lists and replies to inquiries.

### TRADE LISTS

Ensure these are updated and sent regularly to provide relevant information. I suggest price breaks for quantities are worth considering, and try to provide prices "freight in store" rather than ex your nursery, as no one likes surprises. Lists are best, when all plants are alphabetical A to Z, rather than lists within lists, and an indication of what numbers are available is helpful. Naturally Native's list is a good example of what's required.

### LABELLING

Do those who don't want a label on every plant need to subsidise those who do? Likewise, with cleaned pots, I suggest that if your client requires attached labels and clean pots, then they should pay for it. Therefore those who don't require the above should pay less — fair enough, don't you think?

### CONSISTENCY OF SUPPLY

Since the days of plants only being available ex rows of field-grown product, the age of plants as a commodity has arrived. Think of the other commodities and how they are marketed. One of the keys is consistency of supply. Cereal manufacturers never run out of cereal. Here's a list of plants that are commodities, and if any of these are plants you grow, then you should endeavour to always have them. That way, your clients will always buy them from you:

- *Rosmarinus officinalis* Prostratus Group
- Green and black mondo (*Ophiopogon*)
- *Choisya ternata*
- *Syzygium floribundum* (syn. *Eugenia ventenatii*)
- *Syagrus romanzoffiana*
- *Agave attenuata*
- *Convolvulus cneorum*

- *Clivia miniata* (syn. *C. grandiflora*)
- *Camellia sasanqua* 'Setsugueka'
- *Griselinia littoralis* and *G. lucida*
- *Cordyline australis*
- Nikau (*Rhopalostylis sapida*)
- *Iresine herbstii*
- *Trachelospermum jasminoides*
- *Phormium cookianum* green dwarf flax

## COMMUNICATION

It's very difficult to do business when you cannot talk to people. A good phone system is critical. Personally I don't mind if I can only phone you on a cell phone, as long as you are always available on it. Milne's Plant Link communicates with its two top suppliers almost exclusively by cell phone.

## DELIVERY

The distribution of your plants to market in an efficient manner, which suits both you and your client, is fundamental. Personally, we try to be as flexible as possible to accommodate deliveries, but please understand that your plants may be just a fraction of a whole job, so time frames are very significant. Thank you for the opportunity to speak at your conference, and I trust the above comments will help in this ever-changing market.

---

## Replanting for the Future: Environmental Restoration and a Look at What Is Happening in Tauranga City®

### Mark Dean

Naturally Native New Zealand Plants Ltd, Gamman Mill Rd, RD 3, Tauranga

## INTRODUCTION

Tauranga City Council has been committed to a programme of restoring native vegetation and developing wetlands for a number of years. This has been done in association with its storm water programme, where ponds have been built to control flooding. As Tauranga has a number of valley systems cutting through the city into the harbour, this has become a major on-going programme.

Naturally Native New Zealand Plants Ltd first grew plants specifically for revegetation in 1983. These first plants were planted into Johnson Reserve, Welcome Bay, a suburb of Tauranga City. Since the early 1990s Tauranga City has purchased and planted revegetation-grade plants each year.

In 2001 Naturally Native developed a set of plant standards. This was done to set a production standard for the nursery staff to help improve quality. However it was soon realised that the Naturally Native Plant Standard was a sound marketing tool when Councils started adopting it to use in their plant purchase contracts, as a means of defining the standard of plant they required.

It was as a direct result of developing the Plant Standard that Tauranga City signed a contract with Naturally Native to supply and install (plant) revegetation plants each year. Much of this is being done in the extensive wetland areas around the city.

- *Clivia miniata* (syn. *C. grandiflora*)
- *Camellia sasanqua* 'Setsugueka'
- *Griselinia littoralis* and *G. lucida*
- *Cordyline australis*
- Nikau (*Rhopalostylis sapida*)
- *Iresine herbstii*
- *Trachelospermum jasminoides*
- *Phormium cookianum* green dwarf flax

## COMMUNICATION

It's very difficult to do business when you cannot talk to people. A good phone system is critical. Personally I don't mind if I can only phone you on a cell phone, as long as you are always available on it. Milne's Plant Link communicates with its two top suppliers almost exclusively by cell phone.

## DELIVERY

The distribution of your plants to market in an efficient manner, which suits both you and your client, is fundamental. Personally, we try to be as flexible as possible to accommodate deliveries, but please understand that your plants may be just a fraction of a whole job, so time frames are very significant. Thank you for the opportunity to speak at your conference, and I trust the above comments will help in this ever-changing market.

---

## Replanting for the Future: Environmental Restoration and a Look at What Is Happening in Tauranga City®

### Mark Dean

Naturally Native New Zealand Plants Ltd, Gamman Mill Rd, RD 3, Tauranga

## INTRODUCTION

Tauranga City Council has been committed to a programme of restoring native vegetation and developing wetlands for a number of years. This has been done in association with its storm water programme, where ponds have been built to control flooding. As Tauranga has a number of valley systems cutting through the city into the harbour, this has become a major on-going programme.

Naturally Native New Zealand Plants Ltd first grew plants specifically for revegetation in 1983. These first plants were planted into Johnson Reserve, Welcome Bay, a suburb of Tauranga City. Since the early 1990s Tauranga City has purchased and planted revegetation-grade plants each year.

In 2001 Naturally Native developed a set of plant standards. This was done to set a production standard for the nursery staff to help improve quality. However it was soon realised that the Naturally Native Plant Standard was a sound marketing tool when Councils started adopting it to use in their plant purchase contracts, as a means of defining the standard of plant they required.

It was as a direct result of developing the Plant Standard that Tauranga City signed a contract with Naturally Native to supply and install (plant) revegetation plants each year. Much of this is being done in the extensive wetland areas around the city.



## REVEGETATION PLANTS

The City requires that all its plants are eco-sourced. Naturally Native has developed a protocol for eco-sourcing so that seed material is sourced as close as possible to the site in which it will be planted. All eco-sourcing is based on the Department of Conservation ecological regions and districts. All the seed for Tauranga City projects are collected in the Tauranga ecological district. Staff record the source of all seed in the field using a field record sheet developed by the nursery and all seed data is also recorded onto the nursery computer database. This includes recording the GPS location of all the trees seed is collected from and entering this data onto a computer-based mapping programme.

## CASE STUDY 1: MATUA SALT MARSH

Matua Salt Marsh (Fig. 1) is located in Tauranga City in the suburb of Otumoetai on the edge of an inlet facing to the west. Immediately adjacent to the estuary, an area of approximately 5 ha, comprising unused rank *Paspalum* pasture and weeds, was developed into two storm water retention ponds. The ponds were designed to filter storm water through two wetlands before it entered the rather delicate estuarine environment in Tauranga Harbour.

This project commenced in 2001 when seed was first collected. The ponds were constructed during January and February 2002 (summer). Once the earthworks had been completed in May 2002 the planting contractors that were employed by the nursery started work spreading mulch made from chipped waste wood. This was first spread over the site using a small excavator, as the soil was so wet it was difficult for other machinery to move over the site. Planting was done through the mulch. Wetland plants were placed in drifts along the edges of the two ponds. Apart from problems with Pukekoes (swamp hens) pulling out the newly planted rushes, the wetland plants established very easily and grew quickly. An island created in



**Figure 1.** Matua storm water pond 1 year after planting.



**Figure 2.** Mauao (Mount Maunganui) and beach.



**Figure 3.** Planting above the cliffs on Mauao's north face.

the middle of the main pond as a wildlife refuge proved to be a planting headache. Water levels rose faster than anticipated, cutting access, which necessitated the use of a boat to transport plants to the island. Children from the three local schools were invited to participate in the planting in an effort to reduce vandalism. This strategy worked well and the project experienced few such problems. One year later the wetland plants had established very well. By Winter 2004 the two ponds were starting to take on a very natural effect with a variety of wildlife present.

## CASE STUDY 2: REVEGETATION OF MAUAO

Mauao (Mount Maunganui) (Fig. 2) is an iconic extinct volcano standing prominently at the entrance to Tauranga Harbour. Several fires over the past 20 years have destroyed vegetation on the Northern slopes of Mauao. Naturally Native New Zealand Plants Ltd was contracted to supply and plant on a very steep section of the upper northern face in 2003. A particularly devastating fire in January 2003 had destroyed a large area of both revegetation planting from previous years and gorse and bracken in areas previously not planted. The area to be planted was clear of vegetation at the time.

Access was a major problem (Fig. 3). Plants were taken to the top of Mauao by four-wheel drive vehicle to the summit and then sent down a chute that was constructed to slide the plants to the various levels at which they were to be planted. On a planting site such as this safety is a major issue and ropes were rigged to aid the forestry planters, who were used to plant over 3000 plants in 2 cleared days. A similar operation has seen the company plant 20,000 plants on the eastern face of Mauao this year.



Figure 4. Before Millbrook wetland development 2003–2005.

## CASE STUDY 3: RE-CREATING A WETLAND—MILLBROOK

In 2003 Tauranga City storm water engineers constructed a retention pond in a gully that was previously filled with grey willow. The willow was cleared using an excavator and the logs were buried during the construction process. Earthworks disturbed much of the site during the building of the pond, which made planting and subsequent plant establishment difficult (Fig. 4). However 2 years later the site has already established vegetation and wetland species successfully line the fringes of the pond (Fig. 5).

Tauranga City is experiencing very rapid growth and developers are building subdivisions at an alarming rate. Currently it is estimated that just over 50 people are moving into the city per week on average. Prime land is being used for housing while the valleys with their streams that flow into the harbour estuaries and wetlands



**Figure 5.** After Millbrook wetland development 2003–2005.



**Figure 6.** Kopurererua Valley.

are given as a reserve contribution to the city. This leaves the city with a problem as to how to utilise these areas. Walkways are being constructed as parts of an extensive development programme to both promote alternative transport within the city — walking and cycling — and to create a network of parks throughout the city.

In addition a construction programme is underway to develop storm water retention ponds within the city. These ponds usually have a low constructed earth dam with various overflows so that water is restrained during times of flood. Planting of native species, both terrestrial and wetland, is done around the ponds on completion of the earthworks.



**Figure 7.** Vegetation types in the Kopurererua Valley.

### **KOPURERERUA VALLEY WETLANDS**

The Kopurererua Valley (Fig. 6) was purchased by the city to provide land for the construction of a new arterial highway, which was completed in 2003. In the valley there are 350 ha of land that was once extensive wetlands but during the mid 20th century was drained for farming. This poor quality farmland is now to be restored to as near its natural state as possible by re-creating wetlands and retorting native vegetation along its margins. In addition an extensive network of walking tracks, cycle ways and boardwalks will enable the public to use the area.

Naturally Native New Zealand Plants Ltd has entered into a City Partnership programme with the Tauranga City Council to help develop the Kopurererua Valley wetlands. This programme will involve council, business, schools, community groups, and organisations in a 10-year project to develop the valley into a 350-ha park.

Currently the valley has a variety of eco-systems including very degraded willow infested areas, open wetlands that have been grazed by stock for many years, and dry margins where tree ferns grow freely (Fig. 7).

**Community Involvement.** Children are being involved in the project through a Rotary sponsorship of the Trees for Survival programme where children grow seedlings and then plant them out. Seedlings are grown from eco-sourced seed at the nursery and given to the six participating schools to grow on over the summer for planting during conservation week in August (winter).

**Specialist Wetland Plants.** Plants for wetlands are being grown for this project in specially constructed wetland beds at the Naturally Natives' nurseries in Tauranga and Whakatane. These beds allow the water level to be controlled throughout the growing process (Fig. 8).





Figure 8. Wetland beds for growing wetland species.



Figure 9. Spinifex production at Whakatane Nursery.

### COASTAL DUNE RESTORATION

Naturally Native is also involved in supplying spinifex (*Spinifex sericeus*) plants for coastal dune restoration throughout the North Island. The spinifex production is done at our Whakatane Nursery (Fig. 9). Methods for growing spinifex were developed in a co-operative research project with Forest Research from 1996–2000.

Spinifex has the ability to trap sand and so build beaches thus combating beach erosion. The effects of planting spinifex are quite dramatic. Some Tauranga and Bay



**Figure 10.** Replanted spiniflex dune at Papamoa — south east of Mt. Maunganui.

of Plenty beaches now have a significantly different profile since spinifex has been restored to the dune system (Fig. 10). Council sponsored community Coast Care groups receive the plants grown at the Naturally Native nursery and plant them out into the dunes during winter. Growth is fast and the results are dramatic.

## **CONCLUSION**

Extensive programmes of revegetation and restoration of wetlands are being carried out in Tauranga City. Many of the plants being used are being grown and planted by Naturally Native New Zealand Plants Ltd under a partnership programme with Tauranga City Council. The success of this planting programme has been dramatic and planned future planting will see the work being continued over the next ten years.



## Superior Callas: More Than Just Great Flowers®

John F. Seelye, Garry K. Burge, Andrew C. Mullan, and Margaret E. Young

New Zealand Institute for Crop & Food Research Limited, Private Bag 11600, Palmerston North

### INTRODUCTION

In recent years callas have gained significant prominence as a fashionable international cut flower crop. Often referred to as “calla lilies,” they belong to the genus *Zantedeschia* in the arum family (Araceae). *Zantedeschia* taxa are endemic to Africa, particularly the southern regions. The “flower” comprises the often-colourful spathe with a central spadix, the inflorescence, which is made up of numerous male and female flowers. *Zantedeschia* taxa are often classified into winter- and summer-flowering groups with *Z. aethiopica* and *Z. odorata* making up the former. In contrast to all other species, *Z. aethiopica* is evergreen and largely unaffected by soft rots. The summer group has a wide flower colour range including cream (e.g. *Z. albomaculata*), yellow (e.g., *Z. ellottiana*), and pink and red flowers (e.g., *Z. rehmannii*). Hybridization within this group has provided the many distinctive colours seen in modern callas.

### THE GLOBAL INDUSTRY

New Zealand has played a leading role in establishing calla as an international flower crop. Starting in the 1930s, hybridisers such as Tony Brljevič and, later, his son Trevor, produced well known cultivars such as, ‘Black Magic’, ‘Classic Harmony’ (Harmony), ‘Hawaii’, ‘Majestic Red’, ‘Red Sox’, ‘Elegant Swan’ (Swan Lake), and ‘Treasure’. Greater awareness of the value of intellectual property (IP) associated with new germplasm has increasingly led breeders to protect cultivars with Plant Variety Rights (PVR). At present 47 calla cultivars are protected in New Zealand by PVR, half of which were granted rights in only the past 3 years. In addition to breeding programmes in New Zealand, numerous programmes are established in other countries.

New Zealand is still a significant breeder and producer of callas. Annual exports of flowers, tubers, and tissue culture plants were worth approximately \$13 million in 2004, making callas the second most important flower crop after orchids. An estimated 6 million calla plants are propagated by tissue culture annually in New Zealand — more than any other plant. The Netherlands has the greatest flower production area (100 ha in 2000) with 58 million calla stems passing through the Dutch auctions in 2002, an increase of 17% on the previous year. Much of the tissue culture propagation for The Netherlands is carried out in Asia and Eastern Europe.

Calla production is a competitive global business. International companies capitalise on the resources and climatic conditions in various countries to maximise efficiencies at the various production stages, whether it be breeding, propagation, or tuber and flower production. For example, a New Zealand-bred calla can be micropropagated in New Zealand or India, grown on to produce tubers in Kenya or Ecuador, and flowered in Columbia or The Netherlands for consumers in North America and Europe.

## PRODUCTION CYCLE

Cultivated callas grow rapidly over the summer months with tuber growth greatest in autumn when foliage growth has ceased. A period of tuber resting or dormancy follows as shoots senesce until new shoots sprout in the spring. Tubers are typically lifted during the winter months, cured, and stored. Starting from seed or tissue culture plantlets, two seasons growth is usually required before the tubers reach sufficient size to produce flowers. For clonal propagation, tubers with consistently high quality attributes and free from known viruses should be selected. For any sizable tissue culture production, cultures need to be initiated at least 1 year before the plantlets are required, after which there is a further 1 to 2 years of tuber growth followed by another season for flower production.

## PRODUCTION ISSUES AND DISORDERS

Traditionally cultivars were largely selected for their flower colour, shape, and size. However, increasingly plants are being selected for a wider range of criteria, including *in vitro* multiplication rates and the field performances of tubers leading up to flower production. Although calla tissue culture protocols involving proliferating tissue on media supplemented with the cytokinin BAP are well established (Cohen, 1981), large production runs require carefully customised media for specific cultivars to reduce the likelihood of instability during subsequent growth. Cultivar sensitivity to BAP can lead to over prolific and abnormal *in vitro* growth, which can affect subsequent tuber development and lead to tubers with multiple buds often with reduced apical dominance and flowers with reduced spathe length (D'Arth et al., 2002). Similarly, excessive amounts of cytokinins can stunt growth (Chang et al., 2003) producing small plants at deflasking time. Deflasked plants with larger shoot diameters are ideal because they give rise to larger tubers at the end of the first growing season (Chen et al., 2000).

To maximize favourable growing conditions in temperate climates calla tissue culture plantlets must be rapidly acclimatized. However, growth rates are cultivar dependent. We have seen cultivars grown under identical conditions produce tubers at the end of the first season that vary in mean tuber weight from 4 to 35 g, although mean weight for most cultivars was larger than 12 g. Survival under "standard acclimatization" conditions can vary from 100% down to less than 20% for some cultivars. Unless optimized acclimatization procedures are adopted for some cultivars these cultivars may not be cost effective for commercial production. An alternative strategy for producing large first-year tubers with minimal acclimatization issues is to produce *in vitro* calla microtubers (Seelye et al., 2003). The compact and relatively robust form of microtubers makes them easy to handle and transport. In addition, they can be quickly scatter-planted on to prepared greenhouse beds. However, the breaking of dormancy in these *in vitro* tubers must be synchronized for rapid and even sprouting.

Although calla cultivars may have similar flower colour and form, they may behave very differently during the various production stages. Producers must be aware of this, and if necessary, screen out lines that do not perform. For many cultivars in commercial production the exact breeding lineage is unknown, especially of cultivars derived from plants originating from some of the early breeding programmes. Molecular techniques, e.g. RAPD profiles, have been used to successfully differentiate between calla cultivars (Hamada and Hagimori, 1996).

In recent years there have been reports of distorted and reduced leaves in commercial calla hybrid crops, often with mottled leaf colourings (virescent forms) giving the appearance of a severe virus infection. Virescent and albino lines were observed a decade ago when *Z. aethiopica* was hybridized with the summer-flowering species in an attempt to transfer soft rot resistance from the winter-flowering *Z. aethiopica* to the summer-flowering callas (Yao et al., 1995). This leaf disorder is due to plastome-genome incompatibility, resulting in incomplete leaf chloroplast development and albino plants. The pattern of inheritance of leaf disorders within the summer species also shows these incompatibility issues (Brown et al., 2004), but the effect is less severe, resulting in leaf regions with reduced chlorophyll content, which are expressed as a mottle effect. Studies also show that soft rot resistance is reduced in these plants (Snijder et al., 2004). Although the frequency and degree of leaf mottling differs between seasons, it can affect up to 40% of plants in the field. Environmental and chemical influences during the production stages leading up to flowering may influence the already fragile inherited plastids in some of the cultivars in commercial production. Often symptoms do not appear until the second season out of tissue culture and the effect frequently declines later in the season as new leaves are formed. However, the presence of malformed plants in the field can lead to complex liability issues over quality, often involving parties in different countries.

Flowering performance varies between cultivars, but plant management and the growing environment can also have a major influence on flowering. For example, incomplete dormancy-breaking periods due to early tuber replanting can have a negative effect on the physiological development of apical buds, the source of future flowers (Halligan et al., 2004).

### **A QUALITY ASSURANCE SCHEME**

Crop and Food Research in conjunction with Multiflora Laboratories Ltd and Pukekaroro Exotics Ltd, major New Zealand propagators and calla producers/exporters respectively, have assembled a library of selected cultivars and breeding lines. These are maintained in high health greenhouse facilities. In addition, calla lines developed by a large Dutch calla breeding company have recently been incorporated into the scheme. This quality assurance scheme involves closely monitoring tuber and flower performance, and routinely checking plants for known viruses. Tissue cultures for commercial production are initiated from these tubers either annually, or for very large production runs, twice yearly. Sufficient tubers are maintained so that individual tubers are only initiated biannually, thereby giving a full 12-month growth cycle during which tubers may recover from any wounding effects. All tubers, including break-offs from larger tubers, have unique identification codes. Data are captured on the origin of the selected tubers as well as flowering performance, tuber quality, health status, key dates in the production cycle and the movement of tissue into and out of the scheme. All relevant data are logged into a customised database where they remain indefinitely. The system enables flowering plants to be tracked back and compared to the original tuber, ensuring plants have remained true to type. In addition, tissue cultures of recently initiated material are stored *in vitro* so that any issues suspected of being related to the tissue culture production phase can be referenced against the original stock cultures. Regular reviews of the stock plants in the high health system are made and improved lines pe-

riodically introduced to replace existing lines. However, the longer a plant remains in the system, the more data are captured over a number of seasons to support the quality status of a particular tuber.

## SUMMARY

Calla cultivars for flower production not only require superior flower characteristics but must also have well defined production protocols for in vitro propagation, acclimatization, and tuber development stages so that growth is maximized, but susceptibility to abnormalities is minimized. A high health scheme that monitors individual selected tubers over multiple seasons ensures that only tubers with a high health status and good growth attributes are used as the starting material for large-scale clonal production runs.

## LITERATURE CITED

- Brown, F.S., R.C. Snijder, and J.P. van Tutyl.** 2004. Biparental plastid inheritance in *Zantedeschia albomaculata* (Araceae). IXth Intl. Symp. on Flower bulbs, 19–22 April 2004, Niigata, Japan. Abstract P-21.
- Chang, H.S., D. Chakrabarty, E.J. Hahn, and K.Y. Paek.** 2003. Micropropagation of calla lily (*Zantedeschia albomaculata*) via in vitro shoot tip proliferation. *In Vitro Cell. Dev. Biol. Plant* 39:129–134.
- Chen, J.J., M.C. Liu, and Y.H. Ho.** 2000. Size of in vitro plantlets affects subsequent tuber production of acclimated calla lily. *Hortscience* 35:290–292.
- Cohen, D.** 1981. Micropropagation of *Zantedeschia* hybrids. *Comb. Proc. Intl. Plant Prop. Soc.* 31:312–316.
- D'Arth, S.M., S.I. Simpson, J.F. Seelye, and P.E. Jameson.** 2002. Bushiness and cytokinin sensitivity in micropropagated *Zantedeschia*. *Plant Cell Tiss. and Organ Cult.* 70:113–118.
- Halligan, E.A., I.R. Brooking, K.A. Funnell, and J.L. Catley.** 2004. Vegetative and floral shoot development of *Zantedeschia* 'Black Magic'. *Scientia Hort.* 99:55–65.
- Hamada, K. and M. Hagimori.** 1966. RAPD-based method for cultivar-identification of calla lily (*Zantedeschia* spp.). *Scientia Hort.* 65:215–218.
- Seelye, J.F., G.K. Burge, and E.R. Morgan.** 2003. Acclimatizing tissue culture plants: Reducing the shock. *Comb. Proc. Intl. Plant Prop. Soc.* 53:85–90.
- Snijder R.C., P. Lindhout, and J.M. van Tutyl.** 2004. Genetic control of resistance to soft rot caused by *Erwinia carotovora* subsp. *carotovora* in *Zantedeschia* spp. (Araceae), section *Aestivae*. *Euphytica* 136:319–325.
- Yao, J.L., D. Cohen, and R.E. Rowland.** 1995. Interspecific albino and variegated hybrids in the genus *Zantedeschia*. *Plant Sci.* 109:199–206.

## You Have a New Variety?®

**Chris Barnaby**

Plant Variety Rights Office, Private Bag 4714, Christchurch

### INTRODUCTION

There are two themes to this paper. The first (Part A) comments on interaction between variety protection and parts of commercialisation, and the second (Part B) on two proposed new amendments to Plant Variety Rights legislation.

### A) PLANT VARIETY RIGHTS (PVR) AS PART OF COMMERCIALISATION

Many of you have knowledge and experience with commercialisation of new varieties and are hopefully making money out of them. I have no intention of offering any advice on this. What I will try to do is point out some factors in protecting and managing varieties that seem to be overlooked. I say overlooked because I am frequently queried about the points that will be raised and if you are considering protecting your new variety, what should you consider before commercialisation?

The following are some suggestions:

- Why is the variety different? You certainly know, and it may appear obvious, but you need to be able to clearly explain this to others.
- Think about uniformity or plants being true to type. Is the uniformity as good as it could be? If the variety is variegated, look at other variegated plants in the species or genus and judge if your variety is better, worse, or the same. Does the variety remain uniform through repeated propagation?
- The variety name, or denomination for protected varieties. It is desirable for every variety to have only one variety name. The name selected may be suitable for NZ, but if variety export is a possibility, how suitable would it be for other countries, especially non-English-speaking countries? There is a growing trend to have a variety name/denomination and then a commercial or selling name. I understand there are commercial advantages to this approach, but also possible market confusion where a variety effectively has more than one name. Keep in mind that legally and officially there is only one name, and that is the denomination and it must be used.

**Commercial Sales.** There can be some significant consequences following the first commercial sale. If PVR is considered, you have 1 year nationally to lodge your PVR application. There is no flexibility in this. One day more than the 1 year the variety will lose all eligibility. You may wish someone else to bulk up your variety then consider carefully how you do this. Should you contract a specialist propagator such as a tissue culture lab or liner nursery, make it clear in the contract who owns all the plant material at the end of the propagation cycle. Should the propagated plant material become the property of the lab or nursery, then that is a commercial sale and for PVR, the clock has started, perhaps earlier than you wish. There are various contractual safe guards to overcome this, and legal advice would be advisable. An option could be to consider paying the lab or nursery for their propagation services, not for actual plants or at the end of the arrangement, buy back all plant material. It can be confus-

ing when the first commercial sale occurs for breeder's whose varieties are used as cut material. It may be that no plants have been sold, however cut stems have been. Sale of cut material could be interpreted as sale of the variety.

The date of first commercial sale can also be of significance if exporting your variety is a possibility. To lodge a PVR application in another country or the European Union, this must be done within 6 years of the first commercial sale anywhere, for a woody plant species and 4 years for all other species. This applies to exported plants and to cut material where the sale actually takes place overseas. New Zealand-bred cut flower varieties have missed out on variety protection in Japan, due to not being new, because cut stems exported from New Zealand had been sold in Japan and the owners did not appear to take this into account when timing the PVR application for the variety in Japan. You should be aware that there is one country exception to the prior sales rules. To be eligible for a United States Plant Patent, it is advisable to lodge that application within 1 year of the varieties first PVR application date. The United States is the only country that places any significance on an application date with respect to whether or not the variety is new.

**Labelling for Varieties That May Be Protected in the Future.** In previous years I have spoken about labelling protected varieties. More recently there has been discussion between PVRO and several nurseries about labelling of varieties during the 12 months prior sales period. Firstly, the variety has no PVR status and essential it is a free variety. If a competitor begins propagation during that time, prior to application, the competitor is doing nothing wrong. Releasing material before PVR application has a variable level of risk, depending on the species, for the owner and for other propagators. Once PVR application is made, then it is the other propagators who really have the problem depending on how the owner proceeds. A free or non-PVR variety cannot be claimed to be protected in any way, directly or by implication. It is not acceptable and an offence to label a plant protected when it is not, however it is acceptable to give a warning that the variety may be protected in the future by the use of wording such as; PVR may be applied for by a date. The inclusion of a date is important, which would be 12 months after the first date of commercial sale. A solution to all this may be to better integrate the commercial release with the PVR application. I am told there are commercial reasons for not doing this. One of the reasons, I understand is that printing multiple sets of labels with different wording is a major difficulty and cost; however the PVR Act states that claiming a variety is protected when it is not, is an offence.

## **B) ESSENTIAL DERIVATION**

Essential derivation is an entirely new and innovative concept conceived by those who wrote the 1991 International Union for the Protection of New Varieties of Plants (UPOV) Convention. This concept has been proposed for inclusion in amended PVR law, currently under development. An essentially derived variety is one that is considered to be genetically very similar to an initial variety. The second variety is derived from the first, possibly the parent, and could include mutations, genetic engineering, inbreed lines, etc. To be deemed essentially derived, a variety must not only be distinguishable from the initial variety, but also retain the expression of the essential characteristics that result from the genotype or combination of genotypes of the initial variety.

A key feature of PVR is the ability to use protected varieties to produce other varieties, often referred to as the "breeder's exemption" Although highly valued, this has led to some problems. A breeder may spend many years and incur great expense to produce an innovative variety with considerable commercial potential. Under the breeder's exemption, however, another person is free to make a relatively minor change to the variety or identify a spontaneous change (a mutation), to produce a new variety. For example, someone might discover a mutation in the original variety and from it develop a new variety. If the new variety is clearly distinguishable from the original variety the person who developed it is free to protect and exploit it. In other words the second breeder can "free ride" on the investment of the first. The original breeder is unable to stop the second breeder selling the second variety and has no right to share in the profits. It is possible that the second variety becomes more important commercially than the first. This is a problem in apple, rose, or chrysanthemum breeding where mutations occur quite commonly. This situation is addressed by the concept of essential derivation where the second variety could be "essentially derived" from the original or initial variety, and then providing that, while the second breeder may obtain PVR protection of the essentially derived variety, he cannot exploit it without the authorisation of the original breeder. The owner of the initial variety will have no ownership over the derived variety, but will have a say over its commercialisation.

### PROPOSED IMPROVEMENT TO THE RIGHTS OF BREEDERS

The 1991 UPOV Convention, which provides the basis for the proposed changes, enhances the Rights of breeders and allows more effective management of protected varieties. The rights of breeders under the current law and the proposed law are compared in Table 1. The rights provided for in the current law are restricted, and are limited to the production for the purposes of commercial marketing, the offering for sale, and the marketing of the protected variety. The proposed new law (based on 1991 UPOV Convention) provides for greater rights for plant breeders in respect of the propagating material of their protected varieties, and also requires that these rights be extended to varieties "essentially derived" from a protected variety.

The current law has a rather narrow emphasis on commercial sales of protected varieties where the proposed law changes provide a much broader interpretation of commercial activity and provide greater opportunities for management of protected varieties.

**Table 1.** The authorisation of the breeder is required before carrying out the following acts in relation to seed or plant material of a protected variety.

Current law (1978 UPOV Convention)	Proposed law (1991 UPOV Convention)
Production for the purposes of commercial marketing	Production for reproduction (multiplication)
Offering for sale	Conditioning for the purpose of propagation
Marketing	Offering for sale
	Selling or other marketing
	Exporting
	Importing
	Stocking for any of the above purposes



The following examples are some deficiencies in the current law, which could be addressed using remedies in the proposed law changes:

- Currently it is possible to freely export protected varieties providing that all sales and marketing takes place off shore. The Rights holder could take action if protected in the destination market but not at the source. The proposed law change will prevent exports of protected varieties without permission of the variety owner.
- The current Act refers specifically to commercial marketing and offering for sale. It does not address actions such as holding larger quantities of a variety or having stock beds without permission. At present, an owner would have difficulty asserting their Rights if propagation for sale or marketing had not clearly occurred.
- Propagation of protected varieties by noncommercial organisations such as local government or central government agencies currently poses a problem. Propagation does occur but may not for commercial purposes. Currently a Rights owner would have difficulty asserting their Rights, however the proposed law would make this easier as the noncommercial organisation may not be selling the variety but they would be stocking for propagation and production.

## CONCLUSION

With the prospect of enhanced PVR law there are increased opportunities for plant breeders to take full advantage of the potential benefits. To do this, breeders should begin early to consider the key unique characters of the variety, why it is different and how could this be commercially successful. Getting a variety quickly onto the market may be attractive, but is this the best long-term strategy, especially if PVR is part of your commercialisation? Consider carefully the possible significance of the first commercial sale of your variety. A good variety name is crucial and to change a variety name early in the life of a variety is much easier than later. Seek advice from those with experience, work out a plan, and look ahead when beginning commercialisation of your varieties.

## REFERENCE

**International Union for the Protection of New Varieties of Plants (UPOV).** 1991. International Convention for the Protection of New Varieties of Plants, UPOV Publication Number 644 (E), Section 1, UPOV, Geneva, Switzerland.

# Pests Can Be Unintentionally Spread in New Zealand Through Commercial Transport of Nursery Plants<sup>©</sup>

Mark McNeill, John Proffitt, and Craig Phillips

AgResearch, Canterbury Agricultural Science Centre, PO Box 60, Lincoln, Canterbury

Nigel Bell

AgResearch, Ruakura Research Centre, Private Bag 3123, Hamilton

**This study assessed the potential for pests to be transported within New Zealand in association with deliveries of plants between commercial nurseries. Soil and litter were sampled from three deliveries of nursery plants to Christchurch, and searched for associated organisms. A diversity of nematodes, seeds, and arthropods was recovered, including trichodorid and *Xiphinema* nematodes, which can vector some plant viruses and currently have limited distributions in New Zealand. This small survey showed that transport of nursery plants must be an important pathway for the dispersal of a wide range of organisms within New Zealand, including across Cook Strait. The nursery plant industry could stand to directly suffer from the activity of some pest species and perhaps one of the challenges is to come up with a strategy to reduce movements of pests in association with transportation of nursery plants**

## INTRODUCTION

Ministry of Agriculture and Forestry (MAF) Biosecurity aims to prevent foreign, unwanted organisms from becoming established in New Zealand. About 40 unwanted, new organisms were detected in New Zealand in 2003 and this number has been steadily increasing since 1990 (Wilson et al., 2004). MAF may attempt to eradicate newly discovered, unwanted organisms in cases where the potential risk from the organism is high, a successful outcome is plausible, and the intended actions are acceptable to stakeholders (Stephenson et al., 2003; Wilson et al., 2004). Containing the spread of the targeted pest throughout the campaign is fundamental to eradication success (Stephenson et al., 2003). In cases where eradication is not possible, "slow to spread" measures may be implemented to delay distribution of the pest to uninfested regions (e.g., varroa bee mite). Although it is generally difficult to limit pests' natural dispersal (i.e., insect flight, windborne seeds), it is possible to influence the extent to which humans unintentionally assist them to spread. Transportation of plants has obvious potential to assist pests to spread, thus the small survey described here assessed movements of insects, nematodes, and seeds in association with the commercial carriage of nursery plants within New Zealand.

## METHODS AND MATERIALS

In three separate occasions in June 2004, September 2004, and April 2005, a truck and trailer unit delivering plant material to nurseries in Christchurch was sampled for invertebrates and weeds. Plants had been collected from several nurseries in the North Island including Hamilton, Te Awamutu, New Plymouth, and Palmerston

North. The trucks were also delivering plants to a range of other locations between Blenheim and Invercargill. The consignment included flowering shrubs and bagged and bare-rooted trees. Litter was sampled from the top of plant containers along with litter and soil samples taken from the decks of the truck and trailer unit. Sampling was carried out by hand or by using a blower-vac with a net fitted to the inlet to catch the debris.

**Nematodes.** Thirteen kilograms of soil was collected from the June 2004 consignment, and 11 subsamples, each weighing 75 g, were processed to extract nematodes using the tray method of Bell and Watson (2001). Nematodes were observed at 20–80 × magnification and identified to genus where possible. As the June 2004 sample indicated the presence of economically important nematodes, additional sampling was conducted at one nursery to assess the possibility these had become established in Christchurch. At this nursery, bare-rooted trees trucked from the North Island had been dug into rotted sawdust pending their delivery to customers elsewhere in Canterbury. In April 2005, a 25-mm-diameter by 100-mm-deep corer was used to take six samples from each of the following situations: sawdust into which the trees were temporarily placed; soil from an adjacent waste area; soil from under native shrubs; and potting mix from around *Betula pendula* (European white birch). In the latter case the trees had been placed in the sawdust prior to transfer to containers. Samples were transferred to plastic bags and sent to AgResearch Ruakura for extraction.

**Seeds.** From the June 2004 consignment, approximately 2.5 kg of soil was dried for 16 h at 60 °C. The sample was coarse sieved to remove leaf litter and three lots of 500 g of soil were placed in plastic bags. The samples were forwarded to the National Seed Laboratory (AgriQuality Limited, Palmerston North) where any seeds found in the soil were identified.

**Arthropods.** For all three sampling occasions, arthropods were extracted from litter and soil using the Berlesse-Tullgren funnel technique, which relies on heat from a light bulb to drive living organisms from the litter into a collecting vial containing 70% ethanol. Arthropods were categorised into order, family, and life stage (e.g., larvae, adult).

## RESULTS AND DISCUSSION

**Nematodes.** Table 1 shows that species from the family Trichodoridae (probably of the genus *Paratrichodorus*) and *Pratylenchus* species were most abundant in the samples. The trichodorid nematodes can vector some plant viruses (Karanastasi et al., 2000) and in many cases still have limited distributions in the South Island. *Xiphinema* species nematodes were relatively rare in the samples (Table 1), but can be very damaging pests, particularly of woody plants. They cause direct feeding damage to roots, including root swelling, and can also vector plant viruses (Jones et al., 1995). There are currently at least seven species of *Xiphinema* in New Zealand, with the only endemic species being *X. waimungui* (Yeates et al., 1997). *Xiphinema* nematodes have very limited distributions in the South Island: *X. krugi* and *X. radicola* occur in the Nelson area, and only *X. diversicaudatum* has been reported from south of Nelson. The remaining nematode genera shown in Table 1 are distributed throughout New Zealand, with *Pratylenchus* species having the most pest potential, followed by *Helicotylenchus* species, then *Paratylenchus* spe-

cies. The additional samples taken from the Christchurch nursery did not reveal any trichodorid or *Xiphinema* species, and only a small number of *Pratylenchus*, *Paratylenchus*, and *Heterodera* species. The *Helicotylenchus* nematodes were not recovered. This suggests that the while nematodes occurred in the soil at the point of origin, either the remaining soil adhering to the roots of the bare-rooted stock was free of nematodes or they did not survive the transfer into the sawdust at the nursery. Nevertheless, these results clearly indicate that transport of nursery stock has the potential to introduce nematode pests to previously uninfested regions of New Zealand.

**Table 1.** Plant parasitic nematodes observed from soil removed from truck transport and an indication of their abundance and frequency of occurrence in the 11 subsamples.

Nematode group	Likelihood of establishment	Risk factor	Abundance per subsample
Trichodorids	Low	High	Common to abundant
<i>Pratylenchus</i>	High	Moderate	Rare to abundant
<i>Helicotylenchus</i>	High	Low	Rare
<i>Xiphinema</i>	Medium	High	Rare
<i>Paratylenchus</i>	High	Low	Rare

**Seeds Testing.** Seeds from 30 different plant species were found, with *Amaranthus*, *Cardamine*, and *Poa* being the most common species, but 43% of the species were represented by a single seed (Table 2). While none represent significant new weed threats to the South Island, the results demonstrated the potential for inadvertent transfer of economically important weed species (e.g., kikuyu grass), to be unintentionally spread around New Zealand.

**Arthropod Species.** On all three sampling occasions, large numbers of a wide range of arthropods were recovered, with Collembola and Acari being the most abundant (Table 3). Arthropods were found in their nymphal, larval, pupal, and adult stages. The diversity of arthropods shown in Table 3 is probably an underestimate of that associated with the consignments of nursery stock because plant foliage was not directly sampled. Many of the families represented in the samples contain species, which are well known as pests (e.g., springtails, aphids, mites, scales, thrips, and weevils). It seems possible that some very important pests, which still have restricted distributions in New Zealand, might frequently be associated with nursery stock. For example, clover root weevil, which has not been recorded from the South Island, could occur in clovers growing as weeds in nursery plant containers. Similarly, varroa bee mite, which is currently also restricted to the North Island, could be transported to the South Island with bees on flowering plants.

**Table 2.** Plant species and number of seeds recovered from 1.5 kg soil removed on 25 July 2004 from trailer unit transporting plant material from North to South Island nurseries.

Common name	Scientific name	Total seeds
amaranth	<i>Amaranthus</i> species	103
annual mouse-ear chickweed	<i>Cerastium glomeratum</i>	1
bittercress	<i>Cardamine</i> species	22
black nightshade	<i>Solanum nigrum</i>	6
catsear	<i>Hypochaeris radicata</i>	1
clovers	<i>Trifolium</i> (two species)	15
fathen	<i>Chenopodium album</i>	2
grass species	Nine species	38
hairy birdsfoot trefoil	<i>Lotus suaveolens</i>	1
hawksbeard	<i>Crepis capillaris</i>	1
hedge mustard	<i>Sisymbrium officinale</i>	1
hydrocotyle	<i>Hydrocotyle</i> species	1
oxalis	<i>Oxalis</i> species	8
plantain	<i>Plantago</i> (two species)	7
purslane	<i>Portulaca oleracea</i>	1
wireweed	<i>Polygonum aviculare</i>	2
scarlet pimpernel	<i>Anagallis arvensis</i>	1
twin cress	<i>Coronopus didymus</i>	11
violet	<i>Viola</i> species	1
vulpia hair grass	<i>Vulpia bromoides</i>	3

## SUMMARY

Transportation of plants almost certainly provides a significant, unintentional, human-assisted means of spread of many pests within New Zealand. While none of the insects, acarids, or weeds found in these samples appears to be unique to the South Island, the trichodorid and *Xiphinema* nematodes are more restricted in their distribution and are known vectors of plant viruses. The movement of potential pests is clearly not restricted to commercial nurseries and numerous other plant-based industries, as well as amateur gardeners, must also contribute to this issue. The range and volume of plant material being transported around New Zealand, along with the diversity of often-cryptic organisms associated with it, makes it difficult to envisage practical management solutions. Nevertheless, the nursery plant industry obviously stands to suffer directly from the spread of some pest species in New Zealand. Perhaps one of the challenges for the industry is to come up with strategies to reduce movements of pests in association with transportation of nursery plants.

**Table 3.** The order, family, and stage of arthropods extracted from litter and soil collected on three occasions from a trailer unit transporting plant material from North to South Island nurseries.

Order	Family	Stage
Acari (mites)	Orbatidae, Phytoseiidae, others	Adults
Araneae (spiders)	Salticidae, others	Adults
Collembola (springtails)	Isotomidae, Sminthuridae, Entomobryidae	Larvae, adults
Diplopoda	Millipedes	Adults
Coleoptera	Staphylinidae (rove beetles), Curculionidae (weevils), others	Adults, larvae
Diptera	Sciaridae (fungus gnats), Psychodidae (sand flies), Empididae, others	Adults, pupae larvae
Hemiptera (sucking bugs)	Aphididae (aphids), Coccidae (scales)	Adults, larvae
Hymenoptera	Braconidae, Ichneumonidae (parasitoid wasps), Formicidae (ants)	Adults
Lepidoptera	Moths	Larvae, adults
Pscoptera	barklice	Larvae, adults
Thysanoptera	Thripidae (thrips)	Larvae

**Acknowledgements.** We thank Murray Mannall (Southern Woods Nursery) and Grant Hayman (Headford Propagators) and several other nurseries for their assistance and support in this project. We are also grateful to the National Seed Laboratory (AgriQuality Limited) for the seed identifications. This research was funded by FRST contract C10X0317, 'Improved Biosecurity'.

## LITERATURE CITED

- Bell, N.L.** and **R.N. Watson.** 2001. Optimising the Whitehead and Hemming tray method to extract plant parasitic and other nematodes from two soils under pasture. *Nematology* 3:179–185.
- Jones, A. T., D.J.F. Brown, J.M. Halbrendt, T.C. Vrain, R.T. Robbins, D.C. Ramsdell,** and **M. Barba.** 1995. The transmission of three nepoviruses by populations of four *Xiphinema americanum*-group species. *Acta Hort.* 385:105–109.
- Karanastasi, E., I.M. Roberts, S.A. MacFarlane,** and **D.J.F. Brown.** 2000. Retention and release of tobnavirus particles by virus vector *Trichodorid* nematodes. *J. Nematol.* 32:437.
- Stephenson, B.P., G.S.C. Gill, J.L. Randall,** and **J.A. Wilson.** 2003. Biosecurity approaches to surveillance and response for new plant pest species. *N.Z. Plant Protection* 56:5–9.
- Wilson, J.A., B.P. Stephenson, G.S.C. Gill, J.L. Randall,** and **C.C. Vieglais.** 2004. Principles of response to detections of new plant pest species and the effectiveness of surveillance. *N. Z. Plant Protection* 57:156–160.
- Yeates, G. W., B. Boag,** and **D.J.F. Brown.** 1997. Two new species of Longidoridae (Nematoda) from New Zealand forests. *Syst. Parasitol.* 38:33–43.

## Time to Rethink Some Aspects of Agriculture®

### Duncan Burns

Nelson Marlborough Institute of Technology, Richmond Campus, Private Bag 19, Nelson

### INTRODUCTION

As a long serving accredited GROWSAFE® (New Zealand Agrichemical Education Trust, PO Box 10323, Wellington) trainer I have become aware of how useful it is to remind agrichemical users to check out their basic operation methods occasionally. This presentation offers a few suggestions to help improve user safety. “Read the Label” is also fundamental advice, but this is becoming more relevant at present in New Zealand due to current legislation changes. It is interesting to note that these changes are part of a United Nations initiative to harmonise classification and labelling of chemicals globally. GROWSAFE® is the name synonymous with agrichemical training and education in New Zealand.

### A FEW SUGGESTIONS

A simple but realistic suggestion for all agricultural users is to “stop and rethink what you are doing every now and again.” We can become creatures of habit and potentially complacent when undertaking common tasks. I suggest you physically stop, rethink, and/or analyse your tasks when using agrichemicals. Check to ensure you are following best practice. Stop and rethink together with your staff, if that is applicable. A critical analysis from the outside can often spot a fault or area for improvement, which together you can rectify. Under the Health and Safety in Employment Act (1992) in New Zealand employers, with the support of employees, are required to identify hazards and then develop procedures to eliminate, isolate, or minimize them. This basic way of thinking can be easily transferred to the principal of “stop and rethink what you are doing every now and again.”

The majority of us use poly-vinyl-chloride (PVC) gloves when handling agrichemicals. I recommend you change to wearing nitrile gloves. Nitrile gloves are thinner and therefore will allow more dexterity. There is a misconception that they will be weaker because they are thinner, where in fact nitrile gloves are still physically strong and generally chemically superior to PVC. Take for example paint and varnish removers and a solvent such as xylene (which is found in some emulsifiable concentrates). Chemically these fluids have minor to moderate effects on nitrile but have pronounced effects on PVC gloves. When describing general physical performance, nitrile can outperform PVC.

Many of us keep our gloves for too long. Be aware that they have a limited lifespan from both contamination and degeneration over time. I recommend that you consider replacing them more regularly than perhaps you have done in the past. Many users still apply agrichemicals when wearing everyday clothing. I believe this is foolhardy, because in our society we are reluctant to take our everyday clothing off — even if agrichemicals are spilt on them! Wearing overalls when working with any agrichemical is the obvious solution. If the overalls become contaminated they can easily be removed and the user still has everyday clothes on. Swallowing and inhalation are two obvious routes of entry into the body. However, the majority of agrichemical poisoning cases arises from skin absorption. Users with wet



contaminated clothing may be unaware that the agrichemical on the clothing can be absorbed into the body. Wearing overalls instead of everyday clothing can reduce the risk.

I am seeing an increasing number of full-length waterproof aprons being worn at mixing time. They are quick and easy to put on, especially when kept within easy access to the mixing site. Remember you are dealing with the concentrate at mixing time so extra care is needed to keep it off your clothing and skin. A useful tip is to write "inside" and "outside" on the appropriate sides of the apron to keep potential residue away from your overalls.

I believe not enough users protect their eyes properly at mixing time. As well as being sensitive and easily damaged, the eye is very absorbent. Agrichemical can enter the body approximately twelve times faster through the eye than through skin on the forearm. The simple common sense method is to have safety glasses, goggles, or a face shield readily available at mixing time and ensure staff always use them.

## READ THE LABEL

The fundamental advice I can give any agrichemical user is to "Read the Label." But by this I mean read it properly! Too many users only search out the amount of chemical to add to the tank and forget the rest. I strongly encourage users to regularly read the other information on the label, taking particular note of the warnings and precautions described. This is a simple but important message for both you and your staff.

Labels are presently changing in New Zealand, thus there is even more reason to "Read the Label" properly. Under the Hazardous Substances and New Organisms Act 1996 (HSNO, 1996), hazardous substances (which include agrichemicals) have been individually classified in accordance with each of their hazardous properties. This HSNO system of classification is based on the Globally Harmonized System of Classification and Labelling of Chemicals (GHS). The United Nations Economic and Social Council (ECOSOC) published this in late 2003. The GHS is designed to make available a globally harmonized hazard classification and compatible labelling system, including material safety data sheets and easily understandable symbols. New Zealand is one of the first countries in the world to adopt GHS.

In the past an agrichemical had just one classification, but now the new labels will list a number of hazardous properties. The hazard classifications are described with numbers and letters, and these will appear on the new labels. Alongside this we can expect to see a written description of these hazards in plain English. It comes as a surprise to most of us just how many hazards have been identified in the agrichemicals we use. For example the Syngenta product Actara® (Syngenta Group Company, Syngenta Crop Protection Ltd, Auckland) which contains 250g/kg thiamethoxam in the form of a water-soluble granule for the control of scale on kiwifruit (*Actinidia*) has the following HSNO classifications written on the new label: 6.1E, 6.4A, 6.9B, 9.1B, 9.3C, 9.4A. The following warning is then listed:

- May be harmful if swallowed
- May cause eye irritation
- May cause target organ damage through repeated oral exposure
- Toxic to aquatic life
- Toxic to terrestrial vertebrates
- Toxic to terrestrial invertebrates. Toxic to bees.

These warnings match the HSNO classifications as listed above, for instance the 6.4A classification identifies that this particular hazardous substance “may cause eye irritation” and 9.1B classification identifies “toxic to aquatic life”.

The first newly written labels are only now appearing on the market. Be aware that wording may differ between companies, which hasn't always been the case in the past, but that provides even more reason to “Read the Label” completely before use. And expect to see other differences on the new labels. For instance pictograms may appear. We are used to seeing international symbols such as a flame signifying “Flammable Liquid” and skull and crossbones signifying “Toxic.” One new symbol signifies “Target Organ,” meaning that hazardous substance may cause damage to a target organ such as heart, liver, kidneys or lungs. A new pictogram showing a dead fish and tree signifies “ecotoxic.” Under the HSNO Act we can expect to have a greater awareness of environmental damage from hazardous substances and stricter controls to prevent such damage than we have had in the past. Also expect to see more references on the label than in the past to a range of items such as record keeping, re-entry times, approved handler requirements, and the code of practice Management of Agrichemicals (New Zealand Standard 8409).

I have only touched on the changes being brought about by the HSNO Act, but no matter how complicated they are the simple message still remains — “Read the Label” completely before use.

### **GROWSAFE®**

In this country the New Zealand Agrichemical Education Trust (NZAET) has developed and maintains education and training in the safe, effective and responsible use of agrichemicals, under the banner of GROWSAFE®. GROWSAFE® trainers operate nationwide, providing training to agrichemical users – from basic concepts such as reading the label through to more complex changes arising from the HSNO Act.

### **LITERATURE CITED**

- Environmental Risk Management Authority of New Zealand (ERMA).** <[www.ermanz.govt.nz](http://www.ermanz.govt.nz)>.
- GROWSAFE®,** New Zealand Agrichemical Education Trust, PO Box 10323, Wellington <[www.growsafe.co.nz](http://www.growsafe.co.nz)>.
- Hazardous Substances and New Organisms Act.** 1996 (HSNO, 1996). Public Access to Legislation Project. Parliamentary Counsel Office. New Zealand Government. <[http://www.legislation.govt.nz/browse\\_vw.asp?content-set=pal\\_statutes](http://www.legislation.govt.nz/browse_vw.asp?content-set=pal_statutes)> (Search “Hazardous”).
- Le Bas, T., B. Carruthers, M. Gibbs, G. Lanning, V. Lenting, B. Loutit, and E. Mosely.** 2005. A practical guide to the hazardous substances and new organisms act. DSL Publ., Auckland.
- Standards New Zealand.** 2004. New Zealand standard, management of agrichemicals 8409, Standards Council, Private Bag 2439, Wellington.

# Sprinkler Uniformity in Greenhouses and Nurseries<sup>®</sup>

**Peter Savory**

Netafim New Zealand, P.O. Box 53-139, Airport Mail Centre, Auckland

## INTRODUCTION

Greenhouses and nurseries aim to achieve crops that are of a consistent grade and that can be marketed evenly as one line, all at the same time. To achieve this, every plant should receive the same amount of water and at the same application rates. Many growers have long overlooked uniformity of watering systems in the greenhouse and nursery industries and many systems have grown haphazardly as properties have expanded. There are now readily available the sprinklers and the tools to easily design and supply a sprinkler irrigation system that will give the grower uniform watering from sprinkler irrigation systems.

## UNIFORMITY OF DATA

All leading sprinkler manufacturers test their sprinklers in laboratories to gather the data on where the water falls across the sprinkler coverage. Generally most sprinklers have a higher application rate close to the sprinkler and then lesser amounts further out. This data is then used in simple computer programmes such as WinSpace [SPACE (Sprinkler Profile and Coverage Evaluation) for Windows, Centre for Irrigation Technology, California State University, Fresno, California, U.S.A.] to see how even the water is applied at various spacings. Most irrigation designers in New Zealand have this programme available to them. From the WinSpace programme the evenness of the watering pattern is measured by three different formulas. These are:

- Christiansen's Coefficient of Uniformity (CU%)
- Distribution Uniformity (DU%)
- Scheduling Coefficient (SC) (5%)

These are all measures of how even the water is applied to the area and all should be considered when looking at the results. Both CU and DU should be given when considering the results as each formula has its strengths and weaknesses. Christiansen's Coefficient of Uniformity does not always account for the severity of over or under watered areas while Distribution Uniformity may be misleading if individual amounts of the lowest application rates are widely spread over the total area. Scheduling Coefficient gives a measure of the additional time required at the area of lowest application (usually measured over 5% of the area) to achieve the average application rate.

**Table 1.** Desired results for different situations.

Measure of uniformity	Greenhouse	Nursery
CU%	>90%	>85%
DU%	>85%	>75%
SC	1.1	<1.3

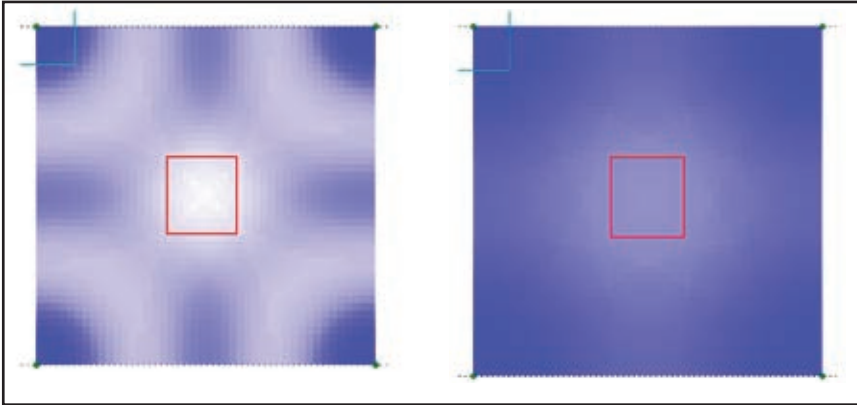


Figure 1. Densogram examples.

### DESIGN OF THE SYSTEMS

Using the WinSpace programme the designer is able to enter the following data:

- Height of sprinkler above the crop.
- Spacing between sprinklers and between laterals.
- Sprinkler operating pressure.
- Sprinkler pattern (e.g., strip watering for tunnels, rectangular, triangular, etc).
- Sprinkler model (nozzle, swivel, and flow).

The result is a uniformity evaluation shown by a densogram.

The densogram examples shown (Fig.1) indicate:

- Sprinklers mounted in each corner.
- Darker area is higher application and lighter area is lesser application rates.
- Areas of most water and least water.

The other data provided is:

- Application rate (mm/h).
- Measures of uniformity CU%, DU%, SC.

### RESULTS

By varying the spacing, model, and pressure it is very easy to find the best sprinkler combination for any given situation. Often by changing the spacings by even the smallest of amounts (<0.5 m) or a change from rectangular to triangular spacings can have a drastic effect on the uniformity.

## The New Start of IPPS-Japan Region®

### Kaneto Aoyama

Kaneya Co., Ltd, 34 Toyohama, Susagaoka, Minamichita-Cho, Chita, Aichi, 470-3412 Japan

My name is Kaneto Aoyama, current president of IPPS-Japan.

For several years now it has been a very hard time for the gardening and horticultural producers in Japan. The membership of I.P.P.S. is working on a horticultural market with the I.P.P.S. motto that is “SEEK AND SHARE.” Currently in Japan the gardening and horticultural markets are beginning to change their business style. Therefore, IPPS-Japan needs to change its management style. The membership of IPPS-Japan is also anxious for IPPS-Japan to change.

In June 2005, we had our 12th Annual Conference in Mie. I would like to express my appreciation to the executive committee members for preparing the conference and all I.P.P.S. members who attended this conference. At this conference we not only had the presentation of research papers but we also had the opportunity to exchange ideas between IPPS-Japan members. If the members are to attend our conferences they will expect to get something from the meeting. To achieve this wish, we decided the subject would be member satisfaction.

As we began the conference planning we received a surprise. To our surprise we found that many IPPS-Japan members did not know each other. Also they did not know what other members were doing or what the membership was interested in receiving from the conference. It was true that we, the IPPS-Japan members are under a very difficult situation currently. I think it resulted from a lack of following our policy of “SEEK AND SHARE.”

We then prepared for the annual conference in Mie with the idea to change that situation. The program has the content, which was “the meeting to exchange the idea of IPPS-Japan member with each other.” It would start with an exchange of business cards between members, introducing themselves to each other, talking about what is interesting to them, what they are expecting, and so on. It was good business exchange for IPPS-Japan members at the conference at that time.

I will be changing the management of IPPS-Japan additionally in the future. We will begin with an extensive change to our IPPS-Japan web page and newsletter revision. It is imperative that we provide more information to our members and provide the opportunity for IPPS-Japan members to exchange information with each other. It should offer a better business chance for IPPS-Japan members.

## Production of Disease-Resistant Tissue Culture Seedlings Using Endophytic Actinomycetes<sup>®</sup>

Hitoshi Kunoh, Tomio Nishimura, Sachiko Hasegawa, Akane Meguro, and Tadao Fujimori

Akatsuka Orchid Co. Ltd., 1868-3 Takanoo-cho, Tsu, Mie 514-2293, Japan

In the mid 1990s several researchers found that a number of actinomycetes inhabit a wide range of plants as either symbionts or parasites. Since then, endophytic actinomycetes have been attractive sources of novel antibiotics and growth regulators of other organisms. Actinomycetes, especially *Streptomyces* species, isolated from the rhizosphere have proven to be excellent biocontrol agents of soilborne plant pathogens. Such an effective activity is largely dependent on secondary metabolites produced by these organisms.

These earlier reports led us to assume that if a useful endophytic actinomycete isolated from a field-grown plant can successfully colonize tissue-cultured seedlings of the plant, the seedlings could become resistant to various plant pathogens. Because tissue culture flasks are usually axenic, such a novel technique should allow this actinomycete to colonize easily its host plant without competition and/or antagonism by any other microbes.

Twenty-five strains of endophytic actinomycetes were isolated from roots, stems, and leaves of field-grown rhododendron. One strain, R-5, that was identified as *S. galbus* was selected as a candidate strain. This strain does not adversely affect growth of the rhododendron seedlings, has a broad antimicrobial spectrum, grows actively on the multiplication medium for tissue culture of rhododendron, and produces two major antibiotics—actinomycin X<sub>2</sub> and fungichromin.

When mycelial suspension of R-5 was spread on the multiplication medium in a glass flask with rhododendron seedlings, mycelia of R-5 grew, sporulated to form powdery colonies on the medium surface within 2–3 days, and colonized inside the plants within 7 days. The seedling on the multiplication medium that was previously treated with R-5 were shown to be resistant to diseases caused by *Pestalotiopsis sydowiana* and *Phytophthora cinnamomi*, major air-borne and soilborne diseases of rhododendron, respectively. Promising protective effects were obtained when R-5 was applied in the tissue culture flasks or directly into soil.

First we assumed that antibiotics produced by R-5 might induce resistance in the seedlings. However, morphological, biochemical, and molecular studies revealed that resistance induced by inhabiting R-5 (acceleration of papilla formation, phytoalexin production, and signal transduction through the jasmonate pathway) might be more directly associated with the disease resistance.

Our *in vivo* test proved that R-5 was an excellent biocontrol agent to produce disease-resistant seedlings of flowering pot plants for practical purposes. This technique was patented in Japan [P3629212 ('04.12.07)] and U.S.A. [US 6,544,511 B2 ('03.04.08)].

## Disease Resistance and Drought Tolerance of *Kalmia latifolia* Induced by Endophytic Actinomycetes<sup>®</sup>

Tomio Nishimura, Sachiko Hasegawa, Akane Meguro, Hitoshi Kunoh, and Tadao Fujimori

Akatsuka Orchid Co. Ltd., 1868-3 Takanoo-cho, Tsu, Mie, 514-2293 Japan

An isolate of endophytic actinomycetes, designated AOK-30, was selected as a candidate for further studies from 73 isolates obtained from field-growing mountain laurel (*Kalmia latifolia* L.) based on growth test on the multiplication tissue culture medium and antimicrobial activity. This isolate was identified as *Streptomyces padanus* based on morphological, physiological, cultural characters, and nucleotide sequences of 16S rDNA. It was tolerant to almost all of routinely used agrochemicals.

Application of mycelial suspension of AOK-30 to the medium surface in flasks where tissue-cultured seedlings were growing successfully induced their resistance to *Pestalotia* disease. Direct soil mixing of the suspension or powdered bean curd with the AOK-30 culture successfully protected transplanted seedlings from *Pestalotiopsis* and *Rhizoctonia* diseases.

Tissue-cultured seedlings turned reddish within 7–10 days after treatment with AOK-30. Osmotic pressure of protoplasts prepared from these seedlings was greater than that of protoplasts from AOK-30-untreated green seedlings. Use of cellulase successfully released protoplasts from the untreated green seedlings, while cellulase and xylanase were required for the release from AOK-30-treated reddish seedlings. These results suggested that cell wall components of AOK-30-treated seedlings could be different from those of untreated green seedlings. Sugar analyses revealed that hemicellulose such as arabinose and callose in reddish seedlings remarkably increased in contents. A further protein analysis of cell wall fraction of reddish seedlings showed the increase of a specific protein showing 100% homology with potato malate dehydrogenase that is supposed to be associated with lignification. The subsequent histochemical test proved that lignification of cell walls was accelerated in reddish seedlings, especially in sieve elements surrounding the vascular system. These results suggested that a high osmotic pressure in cells and chemical modifications of cell walls could be associated with enhanced water retention and thus drought tolerance of AOK-30-treated seedlings.



# Current State of the Fruit-Tree Liner Nursery Industry in Japan. Report No. 1<sup>©</sup>

**Naoki Omori**

Sanyo Nursery, Co. Ltd., 215 Itsukaichi, Akaiwa, Okayama, 709-0831 Japan

Most fruit producers in Japan purchase their plants from propagation nurseries, and this makes common sense. This is especially so with newer clones in which cultivar propagation rights are protected as has occurred in many other flowering plants. I would like to discuss fruit-tree propagation in Japan, which is the beginning process of the fruit production industry.

## OUTLINE OF SAPLING PRODUCTION

In Japan, the prefectures of Ibaraki (Saitama), Aichi, and Fukuoka are major fruit-tree-liner production areas. Those areas are located near Okayama, Yamagata, Niigata, and Nagano, which are major fruit growing prefectures in Japan. In Aichi and Fukuoka, citrus fruit-tree liners are produced, while in the other areas deciduous fruit-tree liners of grape (*Vitis*), peach (*Prunus*), persimmons (*Diospyros*), prune and cherry are produced. In addition, both apple (*Malus*) and pear (*Pyrus*) liner propagation occurs in cold areas.

All fruit tree liner suppliers (nurseries) are producing based on environmental conditions. It is very important that protection is provided from both high temperatures and high humidity during the summer season.

In Japan, grafting methods are used for the propagation of fruit-tree liners with the exception of fig trees and raspberries. The stock selected is determined by the climatic condition, land condition, and/or production method of each area (or each fruit).

When fruit-tree propagators need seeds for understock production, they purchase them from a special trader (nursery or market) or gather them privately. A number of imported seeds from China are now found in the market. Recently, we are finding in the market small stock plants of prune and cherry, which are propagated by the in vitro method. However, there is not a large amount of these in market circulation because the price of the clonal propagule is high.

The original characteristics of some cultivars are not clear, for example, *D. khaki* 'Saijo' or 'Fuyu' (major cultivars of persimmon), because they are very old cultivars and there are many "strains" in Japan. I think it is important to clarify the relationships among these strains (for each cultivar) by genetic analysis for further improvements in fruit production.

## CONCLUSION

The economic status for many fruit-tree propagators is currently very difficult. Propagators are not accustomed to competition because in the past they were under government protection for a long time. However, the situation has changed and it is necessary for producers to develop new markets such as supplying a demand from amateur gardeners.

## Genetic Resources of Indigenous *Citrus* Species at Kinki University®

### Nobumasa Nito

School of Biology-Oriented Science and Technology, Kinki University, Uchita, Naga, Wakayama 649-6493 Japan

From ancient times *Citrus* species have been used as fresh fruits, medicines, and ornamentals in Japan. Tachibana and cherry trees have been planted in the old Imperial Palace as the holy trees. *Citrus* is one of the most important fruit trees in the world and is cultivated in temperate, subtropical, and tropical areas.

Although the origin and time of introduction is unclear, we have many old species such as tachibana (*C. tachibana*), shekwasha (*C. depressa*), daidai (*C. aurantium*), yuzu (*C. junos*), and kabosu, koji to name some. Kishu-mikan (*C. kinokuni*) is one of the earliest species introduced into Japan, where it was the most popular species because of its pleasant flavor and rich fragrance during Edo era. But, Kishu-mikan was replaced by Satsuma mandarin during those 200 years. Satsuma mandarin (*C. unshiu*) originated in Kagoshima prefecture, southern part of Kyushu Island, and has been the leading type in modern Japanese citrus industry. It produces high quality fruits without seeds in the climate condition in Japan. More than 200 cultivars have been obtained by bud mutation and breeding programs. In addition, some species of *Citrus* originated in Japan such as natsudaidai (*C. natsudaidai*), hassaku (*C. hassaku*), Iyo-kan (*C. iyo*), hyuganatsu (*C. tamurana*), sanboukan (*C. sulcata*), and some pummelo cultivars.

Trifoliolate orange (*Poncirus trifoliata*) was introduced into Japan in ancient time and has been used as a rootstock for *Citrus* cultivars. Kumquat (*Fortunella* sp.) has been used for ornamental and medicinal usages.

About 180 species and cultivars of the indigenous *Citrus* are maintained in the germplasm collection at the Experiment Orchard of Kinki University. These materials are used for taxonomic studies and in pursuit of the origin.

Indigenous species are compatible to the climate condition and grow vigorously with fewer chemicals. We can expect medicinal and ornamental uses with these indigenous materials. We want to share the information on *Citrus* species and cultivars indigenous to Japan.

## MIYOBI: A New Fertilizer Containing Abscisic Acid<sup>®</sup>

Yasuo Kamuro

BAL Planning Co., Ltd., 2-15-16, Hanaike, Ichinomiya, Aichi 491-0914, Japan

### INTRODUCTION

MIYOBI is the commercial name of new fertilizer that contains the natural type of abscisic acid [SABA (S)-(+)-ABA 5-[(1S)-1-hydroxy-2,6,6-trimethyl-4-oxo-2-cyclohexen-1-yl]-3-methyl-2,4-pentadienoic acid], and that was registered in Japan in Dec. 2003 (Table 1).

**Table 1.** Formulation of MIYOBI.

Percent a.i. (w/w) in MIYOBI	
Agents as fertilizer	
Water soluble K:	8.0
Water soluble P:	5.0
Water soluble Mg:	0.90
Water soluble Bo:	0.50
Water soluble Mn:	0.30
Activator of fertilizer	
SABA:	10.0

The natural type of abscisic acid is found ubiquitously in the plant kingdom, and it is well known that SABA inhibits the K-ion pump (Walton, 1980). In addition, it is also generally known that K-ion shows growth-promoting effects such as tissue differentiation, improvement in photosynthesis, biosynthesis of proteins and pigments, flower bud differentiation, and fruit maturation.

Natural type abscisic acid shows totally different physiological effects when compared with racemic ABA, which is chemically synthesized. For example, SABA promotes plant growth at a low dosage and inhibits growth at a high dosage (Kamuro, 1994; Kamuro et al., 1992). It is also very interesting that the combination of SABA and GA<sub>3</sub> showed synergistic promotive effects on photosynthesis, vegetative growth, flowering of long-day plants, fruit-set, and fruit-thickening growth (Kamuro et al., 1997; Kamuro et al., 2001; Nozawa-Gloria et al., 2003). The objective of this research was to study the effects of SABA and GA<sub>3</sub> treatments, alone and in combination, on photosynthetic rate and vegetative growth.

### MATERIALS AND METHODS

Two-year-old camphora trees (*Cinnamomum camphora* L.) were used as test plants. Each plant was grown in a pot 7 cm in diameter. Individual plants were 15 cm in height and had 10 leaves. This research was carried out in September. Four test plots were set up as shown in Table 2. Five plants in each plot were sprayed with SABA 10 ppm, GA<sub>3</sub> 50 ppm, SABA 10 ppm + GA<sub>3</sub> 50 ppm, or water only (control). Photosynthetic rate was investigated under the conditions of 23–24 °C and 1050 μmol·m<sup>-2</sup>·s<sup>-1</sup> at 7 days and 30 days after spray treatment. Growth increment at 34 days after treatment was recorded.

**Table 2.** Effect of SABA and GA<sub>3</sub> treatments on photosynthetic rate and vegetative growth in young plants of camphora tree (Kamuro et al., 1992)

Spray treatment	Photosynthetic rate (%)		Growth increment/plant (%) at 34 D.A.T.		
	7 D.A.T.	30 D.A.T.	Plant height	Leaves D.W.	Root D.W.
Control	144.5*	124.2*	2.7cm	0.84g	0.68g
	(100%)	(100%)	(100%)	(100%)	(100%)
SABA 10 ppm	106.3	94.7	92.6	98.8	141.2
GA <sub>3</sub> 50 ppm	103.0	122.0	800.0	120.2	94.1
SABA 10 ppm + GA 50 ppm	121.9	136.0	740.7	133.3	126.5

\*nmol CO<sub>2</sub>/s/plant, D.A.T. = days after treatment, D.W. = dry weight.

**Table 3.** How to use "MIYOBI" on crops.

Effects	Crop	Treatment and Dosage (MIYOBI: g per L <sup>-1</sup> water)
Establishment increase (%) and vigorous growth	Seed	Quick dipping (1 g per 5 L), or Soaking for one night (1 g per 500 L)
	Bulb	Mix treatment with GA <sub>3</sub> 1-5 ppm is recommended in some cases.
Increasing rooting (%) and prevent wilting	Cutting	Spray on cutting, seedling, or nursery stock 1-2 days before transplanting (1 g per 5 L)
	Seedling	
Growth promotion and yield increase	Vegetable	Spray at the 2-5 true leaves stage 1 or 2 times at intervals of 20 days (1 g per 5 L)
	Root crop	
Growth promotion and early flowering	Nursery stock	Mix treatment with GA <sub>3</sub> 5-20 ppm is recommended in some cases.
	Long-day ornamental plant	
Fructification increase (%) and under unfavorable weather conditions.	Fruit tree	Spray at the beginning stage of flowering.
	Vegetative fruit and leguminous crops	1 or 2 times at intervals of 20 days. (1 g per 5 L)
Preventing of early fruit drop and fruit thickening	Fruit tree	Spray at the early stage of fruit growth.
	Vegetative fruit	1 or 2 times at intervals of 20 days (1 g per 5 L + GA <sub>3</sub> 5-20 ppm)
Dwarfing	All kinds of plant	Spray at the early stage of stem elongation. (1 g per 2 L + Ethephon 100-200 ppm)

## RESULT AND DISCUSSION

The test results are shown in Table 2. The combined treatment of SABA and GA<sub>3</sub> showed increased effects on photosynthetic rate and dry weight per plant. It is very interesting to note that the combined treatment was more effective on dry weight increase of both top and root growth. These effects might result from the combined treatment promoting an increased photosynthetic rate, however, the mode of action is not yet cleared.

It is generally understood that abscisic acid counteracts the physiological action of gibberellins. A racemic ABA mixture has been used generally for research in plant physiology and showed only weak effects on growth promotion. We have previously reported that SABA showed totally different effects on plant growth when compared with racemic ABA and that mixed applications of SABA and GA enhanced the physiological actions of GA as mentioned above.

We also reported that mixed treatments of K-ion and SABA were effective in promoting these growth phenomenon mentioned above. So, SABA was added as an activator in fertilizer. A useful fungus that is available for wine brewing since old times produces SABA, which is added in MIYOBI. Racemic ABA, which is chemically synthesized, does not work for this purpose.

MIYOBI is valuable only as a foliar spray and not effective as a soil treatment because SABA is easily inactivated in soil.

Currently SABA is registered as a fertilizer activator and MIYOBI is available for agricultural production in Japan, Korea, and Taiwan. The use of MIYOBI on various crops is shown in Table 3.

## LITERATURE CITED

- Kamuro, Y.** 1994. The present situation and problems in the R&D for practical uses of abscisic acid (in Japanese). *Chem. Reg. Plants.* 29:155-165.
- Kamuro, Y., S. Matsui, and M. Shirai.** 1992. Practical uses of (S)-(+)-abscisic acid: Inhibiting, delaying, or increasing effects on flower bud formation. *Proceedings of 19th Plant Growth Regulator Society of America*, p. 405-408.
- Kamuro, Y., S. Matsui, H. Kuriyama, and H. Fujisawa.** 1997. Synergistic effects of GA<sub>3</sub>/ABA-derivative or GA<sub>3</sub>/jasmonic acid-derivative on growth and flowering of plants. *Proc. 24th Plant Growth Regulat. Soc. Amer.*; p. 48-53.
- Kamuro, Y., S. Onwona-Agyeman, and S. Matsui.** 2001. The promoting effect of applying mixtures of (S)-(+)-abscisic acid and gibberellic acid on flowering in long-day plants. *Plant Growth Regulat.* 33:189-194.
- Nozawa-Gloria, T., Y. Hirata, Y. Kamuro, and M. Shibata.** 2003. The effect of abscisic acid on growth promotion. *Comb. Proc. Intl Plant Prop. Soc.* 53: 435-439.
- Walton, D.C.** 1980. Biochemistry and physiology of abscisic acid. *Ann. Rev. Plant Physiol.* 31:477-478.

# Rapid In Vitro Production of Plants From Immature Seeds in *Lilium japonicum*<sup>®</sup>

Hidehiro Inagaki, Hisao Otsuka, and Yoshinori Terada

Shizuoka Agricultural Experiment Station, 678-1 Tomigaoka, Iwata-shi, Shizuoka 438-0804, Japan

## INTRODUCTION

To control the period from sowing to flowering is important in the cultivation of seed-propagated ornamental plants. However, commercial cultivations of some plants are difficult because of their long periods from sowing to flowering. *Lilium japonicum* Thunb. is a wild lily native to Japan and of great potential as an ornamental plant. Although seed propagation is generally used for its mass propagation, it takes a very long time from sowing to flowering (about 6 to 7 years). Therefore, its commercial cultivation has not been established.

In this report, we investigated characteristics of seed germination and developed a new method with immature seed culture to promote seed germination and to rapidly produce plants, which allows shortening the period to flowering.

## MATERIALS AND METHODS

**Germinability of Immature Seeds.** Immature seeds of *L. japonicum* were collected from six capsules at various maturities. Lengths of seeds and embryos were measured monthly after pollination. Twenty seeds were placed in a 90-mm-diameter petri dish containing 20 ml of the Murashige and Skoog (MS) solid medium (Murashige and Skoog, 1962) or water agar medium without MS salts. Twelve dishes were kept at 20 °C under a long-day photoperiodic condition ( $74 \mu\text{mol}\cdot\text{m}^{-2}\cdot\text{sec}^{-1}$ , 16 h). The number of germinated seeds was recorded every 40 days for 200 days after the start of culture.

**Influence of High Temperature Treatment on Germination of Immature Seeds.** Immature seeds 3 or 4 months after pollination were prepared. Sixteen seeds were placed on MS solid medium in a plastic petri dish. For high temperature treatment, 12 dishes were kept at 30 °C for 50 days and then kept at 20 °C. For control, 12 dishes were kept at a constant 20 °C. Both cultures were carried out under a long-day photoperiod condition ( $74 \mu\text{mol}\cdot\text{m}^{-2}\cdot\text{sec}^{-1}$ , 16 h). The number of germinated seeds was recorded at 40-days intervals during 120-days culture.

**Influence of Pre-Treatments on Germination of Immature Seeds.** Immature seeds 3 months after pollination were pre-treated with the following methods: (1) scarification (making a small cut in the seed coat); (2) soaking in 0.5% NaClO for 20 min; (3) no treatment (control). Sixteen seeds were placed on MS solid medium in a plastic petri dish. Twelve dishes were used for treatment and kept at 20 °C under a long-day photoperiod condition ( $74 \mu\text{mol}\cdot\text{m}^{-2}\cdot\text{sec}^{-1}$ , 16 h). The number of germinated seeds was recorded every 40 days for 200 days after the start of culture.

## RESULTS AND DISCUSSION

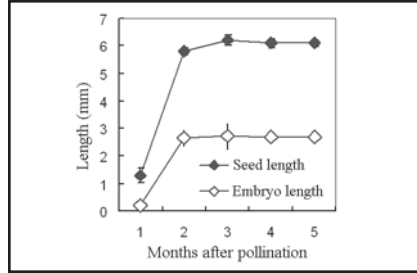
**Germinability of Immature Seeds.** Seeds and embryos reached their final sizes in 2 months after pollination (Fig.1). Though immature seeds 2 months after pollination did not germinate on water agar medium, they germinated on MS medium. In contrast, there was little difference in germination of seeds collected 3 to 4 months after pollination between water agar medium and MS medium. Culture on MS me-

dium promoted germination of immature seeds. Germination rate of mature seeds 5 months after pollination declined on water-agar medium, while it increased on MS medium. Furuya (1999) suggested that mature seeds of this lily species have dormancy. Our data support that seeds became dormant when mature.

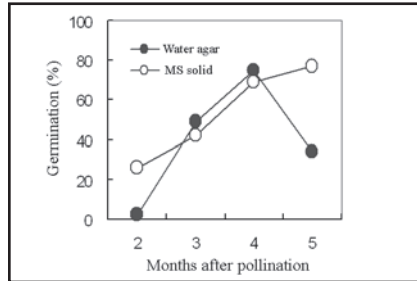
It is unknown why mature seeds did not demonstrate apparent dormancy on MS medium. The possibility that some MS salts may have a breaking effect on seed dormancy remains to be studied in the future.

**Influence of High Temperature Treatment on Germination of Immature Seeds.** In the previous experiment, immature seeds were also germinable (Fig. 2). However, their germination rate was not high. Therefore, we investigated effect of high temperature treatment on germination of immature seeds to improve the germination rate. High temperature treatment improved germination rate of immature seeds 4 months after pollination (Fig. 3). This suggests that the cause of low germination of immature seeds 4 months after pollination is seed dormancy and that dormancy can be broken by a high temperature treatment. In contrast, germination of immature seeds 3 months after pollination was not affected by high temperature treatment (Fig. 3). The sensitivity to high temperature may develop later than 3 months after pollination. High temperature treatment is effective to promote germination of immature seeds 4 months after pollination. However, it is desirable to use more immature seeds for obtaining plants rapidly. Therefore, we conclude that high temperature treatment is not useful for this purpose.

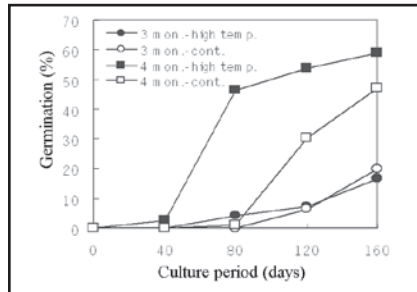
**Influence of Pre-Treatments on Germination of Immature Seeds.** In our experiment, we investigated pre-treatment methods to promote germination of immature seeds collected 3 months after pollination. As a result, scarification treatment significantly improved the germination rate of immature seeds 3 months after pollination (Fig. 4). In addition, germination was promoted after a soaking treatment in NaClO (Fig. 4). A soaking treatment is easy for mass propagation compared with scarification. Hence, we consider that soaking treatment in NaClO is effective for pre-treatment of immature seeds.



**Figure 1.** Growth curves of seeds and embryos after pollination in *Lilium japonicum*. The bars represent SD ( $n = 6$ ).



**Figure 2.** Germination rate of immature seeds at various maturities after pollination on water agar or MS medium. Data were taken after 200 days of culture.



**Figure 3** Effect of high temperature treatment on germination of immature seeds three (O, ●) or four months (□, ■) after pollination. Open symbols (O, □), control; closed symbols (●, ■), high temperature treatment.



### Method of Immature Seed Culture to Promote Germination.

Figure 5 shows a comparison of growth among three methods. In the case of existing methods, bulblets weighing 0.1 g were obtained 22 months after pollination (April of 3rd year) when grown in the soil method, or obtained 10 months after pollination (March of 2nd year) using the temperature treatment method (Kamata, 1987). On the other hand, in immature seed culture developed as a new method in our study can provide bulblets with an average weight of 0.5 g 7 months after pollination (January of 2nd year). In vitro cultures to promote bulblet growth have already been investigated extensively (Fukui et al., 1989; Kawarabayashi, 1993; Haruki et al., 1996, 1998; Inagaki et al., 2003). Thus, bulblets weighing over 3.0 g were obtained in April of 2nd year using a liquid culture for 90 days following immature seed culture. When bulbs were planted in containers after experiments, we observed the first flowering 2 years after planting.

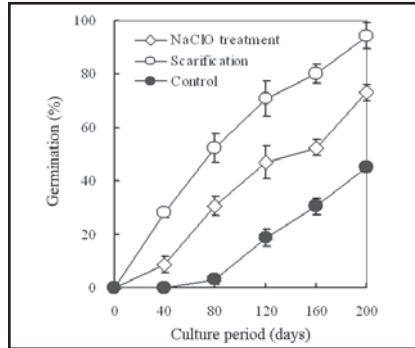
From these results, it is concluded that the culture of immature seeds is an effective method to promote germination.

Furthermore, the time to flowering could also be shortened considerably using immature seed culture.

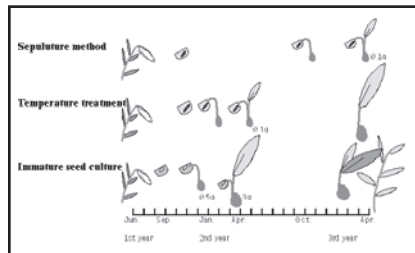
**Acknowledgment.** The authors are grateful to Prof. H. Ohno of Shizuoka University for careful reading of the manuscript.

### LITERATURE CITED

- Fukui, H., N. Adachi, T. Hara, and M. Nakamura. 1989. In vitro growth and rapid multiplication of *Lilium japonicum* Thunb. *Plant Tissue Cult. Lett.* 6:119-124.
- Furuya, H. 1999. Methods of the seeding production of native plants with in vitro culture. 2. *Lilium japonicum* Thunb. *Bull. Hiroshima Agric. Res. Cent.* 67:51-60 (In Japanese).
- Haruki, K., T. Hosoki, and Y. Nago. 1998. Effects of illumination on nutrient absorption from the liquid-shaking medium by enlarging miniature lily bulbs (*Lilium japonicum* Thunb.). *J. Japan. Soc. Hort. Sci.* 67:106-111 (In Japanese).
- Haruki, K., K. Yamada, T. Hosoki, and K. Ohta. 1996. Effects of nitrogen source, phosphate and sulfate in liquid-shaking culture on the growth of miniature bulbs of *Lilium japonicum* Thunb. *J. Japan. Soc. Hort. Sci.* 65:387-396 (In Japanese).
- Inagaki, H., Y. Terada, H. Otsuka, and K. Kato. 2003. Mass propagation method of bulbs of *Lilium japonicum* Thunb. through immature seed culture techniques in the liquid medium. *Bull. Shizuoka Agric. Exp. Stn.* 48:57-62.
- Kamata, K. 1987. Method of seeding with lilies. p.132-136. In: Shimizu, M.(ed.). *The lily in Japan, species and hybrids.* Seibundo Shinkou-sha, Tokyo (In Japanese).
- Kawarabayashi, W. 1993. Effect of several conditions in aerated liquid culture on in vitro multiplication of bulbs of *Lilium japonicum* Thunb.. *J. Japan. Soc. Hort. Sci.* 62:197-205.
- Murashige, T., and F. Skoog. 1962. A revised medium for rapid growth and bioassays with tobacco tissue cultures. *Physiol. Plant.* 15:473-497.



**Figure 4.** Effect of pre-treatments on the germination rate of immature seeds (3 months after pollination). The bars represent SD (n = 12).



**Figure 5.** Comparison of growth season among immature seed culture and other two existing methods.

## The Effect of Slits of Circle Slit Cancel Pot (CS POT)<sup>®</sup>

### Mikio Minamide

Minamide Co., Ltd 7-8-5 Kanbe, Suzuka, Mie 513-0801, Japan

Simply speaking, the characteristics of circle slit cancel pot (called CS POT or “Ton-demonai Pot”) is that the slits at the bottom of the container stimulate the growth of many new healthy roots, for the slits allow the excess water from watering to drain out of the container soundly and the main root to receive sufficient air to grow well. I think my containers (Table 1) are superior to others on the point of fostering root growth.

The excessive moisture in the container causes circling of the roots, which is considered to be one of the biggest concerns when we produce containerized plants. On the inside of containers water moves along the following courses mentioned below

**Table 1.** The lineup of CS containers (containers with slits).

Type	Japanese Name	Size
Circle slit cancel pot for breeding	CS Plug-tray	406-40 holes & 128 holes (for machinery)
Circle slit cancel pot for producing, breeding, gardening and planting	CS POT	6.5 $\phi$ – 30 cm and 50 cm
Circle slit cancel pot for breeding and producing	Polyester-pot	9 cm $\phi$ – 15 cm $\phi$
Circle slit cancel pot for gardening	Kesyo-pot	9 $\phi$ – 21 $\phi$
Circle slit cancel pot for gardening	Kengai-pot	18 $\phi$ – 30 $\phi$

**Table 2.** A difference of both the flow of water and root development of plants between three types of containers (In the Polyester Pots, you can grow the roots like that are fostered in the CS POT with the greatest care). You will be able to make excellent growth in polyester pots if you wish.

Polyester Pot	
Dry Suitable humidity	The roots easily tend to circulate by themselves.
Nonwovens Pot	
The middle of the soil is dry. The water evaporates through the stitches. The bottom of the soil becomes humid because of the clogging water.	Although the main roots grow well with new roots, it is extremely difficult to grow them in the middle of the container.
CS POT	
Excess water from watering will be able to drain out of the container and water is dispersed evenly in the soil.	When meeting the slits, the roots stop growing temporarily. Also, the number of new roots increases.



**Figure 1.** Camphor tree (*Cinnamomum camphora*), 1.8 m in height, in polyester container. The roots have become woody and are circling the container.

(Table 2). The containers made from polyester, vinyl chloride, or plastic drain out most of the excess water after watering; however, some water remains between the container and soil because of surface tension. In addition, the circle holes prevent the soil from getting sufficient air because the water fills such holes owing to surface tension. Also, dew forms inside of the containers because of a difference between the day and night temperatures. This condensation produces too much humidity in the containers. As a result, the roots start circling along the container wall to get sufficient air. Circling roots have two bad influences on the growth of plants. First, plants usually absorb nutrition or water from their root tips. If circling happens, the number of these tips absorbing sufficient nutrition and water decreases. Thus, circling causes the plants to have a reduced absorption power. Second, the circling roots, which become woody because of accumulated lignin, prevent the formation of new roots and cause a plant to age (Fig. 1).

Because of the slits, CS POT can drain excess water following watering owing to surface tension and condensation. Because containers do not have any excess water after watering, water is dispersed evenly in the soil. As a result you can control watering more easily because you can check how the soil is drying by observing the



**Figure 2.** Circle Slit Cancel pot (CS POT).

soil surface. Also, if the soil is given excess water, it is rare for the soil to become waterlogged. The projections, 1 mm in height, and slant of the CS POT wall lead the roots downward without circling (Figs. 2 and 3). Additionally, these projections work as a radiator. The temperature in the container drops faster, because these projections make the surface area of the container bigger.

As mentioned earlier, the construction of the container leads the roots downward. These roots stop growing temporarily when they come in contact with the air. This stopping does not mean that the roots are dead. When sufficient air is given to the roots, the cells of the root tips become smaller and smaller, and undergoing hormonal stress, the roots cease growing temporarily. When ceasing the growth, the roots have mulberry spots. These spots indicate that growth hormones are produced at those root tips. Because of the translocation of these growth hormones to the aboveground plant parts, leaves, buds, and fruits become bigger. Due to a



**Figure 3.** Camphor tree (*Cinnamomum camphora*) 1.8 m in height, in CS POT (24 cm in diameter). After 1½ years of culture in CS POT many new roots are formed down from the proximal part of the root. When viewing the growing points you will note that many of the root tips have ceased growth.

translocation of growth hormones produced from the aboveground to roots, it can become possible for the main root to have new roots not only at the lower but also at the upper part. Thus, it is clear that the main root has new roots at the middle part (Figs. 4 and 5).

The CS POT has slits at each corner of the hexagonal or octagonal bottom of the container (Fig. 2). The roots by nature gather around the corners. Therefore, all the roots ceasing growth gather around each slit. As a result, it becomes possible that the roots produced in the CS POT do not circle and the main root has new healthy roots from the top to the bottom. Thus, you can grow plants for a long time





**Figure 4.** Camphor tree. A washed view of Fig. 3 showing a lot of new roots in the middle of the pot.



**Figure 5.** A sectioned diagram of the root mass of *Gardenia jasminoides* (Cape jasmine) (50 cm) in CS POT (24 cm in diameter). There are lots of new live roots at not only the middle and lower levels but also the upper part of the main root mass.



**Figure 6.** Conifer (ball bird). Right: CS POT (15 cm in diameter). The main roots have lots of new live roots growing downward evenly. Left: Typical pot (15 cm in diameter). The root rot has been caused by excessive water.



**Figure 7.** Udo (*Aralia cordata*) in CS POT (24 cm in diameter).





**Figure 8.** *Loropetalum chinense* (white, pink, red selection) in CS POT (50 cm in diameter).



**Figure 9.** Stands of planted trees making the use of CS POT (50 cm in diameter). These CS POT containers are edged with hyaku-monogatari (a kind of fence made from thinning trees).

without changing the container because the slits delay root aging (Figs. 6 and 7). Also, when transplanting from CS POT into a landscape site or the next larger container the plant immediately roots into the soil and their growth at the next pot size or place is very good. The reason this occurs is because the roots that had stopped growing immediately become active and start growing following transplanting.

The CS POT is useful for the production of trees, flowers, vegetables, and fruits. As often shown in the popular gardening publications in Japan such as *Amateur Gardening* and *The Guide to Gardening*, CS POT containers have nationwide popularity among gardeners growing plants such as blueberries, chrysanthemums, roses, and Christmas roses. Now, we would like to introduce our newest use for the CS POT (especially the CS POT 50 cm in diameter)—tree planting on roof gardens and stands of planted trees making the use of CS POT (Fig. 8).

In the currently used containers the roots begin circling and aging in 1 or 2 years. Therefore, a change in containers is needed because they are not suitable for such tree plantings. Our CS POT containers allow the trees to grow for a longer time because new healthy roots are produced in the whole soil mass of the container. Because of this feature, the plants are not aging and the changing of containers is not needed for a longer time. This broadens the use of CS POT to tree plantings around houses, buildings, parks, and exhibitions (Fig. 9).

## Hokkaido Travels for Post Tour in 2004 IPPS's International Meeting®

### Masaru Shibata

Ohken Co.,Ltd. 16-16 Ueno-cho, Kameyama, Mie, 519-0112, Japan

International Board Meeting is held at different regions every year by a rotation system in the eight regions. Last year, in 2004, the International Board Meeting was held in conjunction with the IPPS-Japan's Shizuoka Annual Conference. At this conference, as usual, a post-conference tour was planned. To explore the beautiful autumnal tints and great nature of Japan, I selected Hokkaido because early fall has become a popular destination at this time of year in the north island of Japan. The list of participants on the tour and my impressions are as follows.

**The First Day (10 September 2004).** In early morning, we departed from Hamamatsu to Nagoya by Shinkansen and arrived at New Chitose airport at 10:30 AM via Nagoya airport. By chartered bus we toured to Hokkaido Research Station, which belongs to Snow Bland Seed Co., Ltd. (1066, Horonai-aza, Naganuma-cho, Yubari-gun, Hokkaido, 069-1464, Japan). This is one of the major seed companies in Japan. Here, crops such as forage grasses, legumes, F1 corn for feed and manure crops, vegetables, and flower and ornamental plants are bred. We were welcomed by Mr. Yamashita (director) and all his staff and had a splendid lunch and fully enjoyed natural honey corn, potato, and fresh milk. All members were very satisfied with these traditional Hokkaido-like foods! Next we toured the field trials and visited greenhouses in which we saw the breeding of *Cyclamen* or *Begonia* crops. Lastly, we observed the unique tissue culture technology used with cyclamen. Dr. Ken Tilt was especially interested in this technology. At the second stop, we visited the Forestry Museum belonging to Oji Paper Co., Ltd. (Kuriyama-cho, Yubari-gun, Hokkaido, 099-1508, Japan <<http://www.ojipaper-ebetsu.jp/top.htm>>). The site is 30



Figure 1. Beautiful wide panorama view from Biei Hill, Hokkaido.



**Figure 2.** Memorial photograph at Hokkaido Experimental Forest of Tokyo University at Furano, Hokkaido. The total participants were 14 people; from USA: Helen Gilbert, James Gilbert, Margaret Parkerson, Charles Parkerson, Elizabeth Marshall, Richard (Dick) Marshall, Barbara Smith, James Smith, Ken Tilt, and Fred Garrett. From GB&I: Peter Birmingham. From Australia: David Daly. From Japan: Fuwa and Iizuka.

ha in area and was composed of numerous research trials with trees such as *Populus*, *Betula*, *Alnus*, *Abies*, *Picea*, and *Larix*. These trees have been studied mainly as materials for pulpwood. Everybody enjoyed an example of a natural regeneration model with *Abies*, which was explained by Mr. Koda, director of the Museum. Mr. James Gilbert and Mr. David Daly especially liked the forest and trees and enjoyed the forest atmosphere. In the evening we enjoyed a special meal of roast mutton and delicious ice cream. I was surprised that most of the foreign guests ate more than two times what the Japanese ate.

**The Second Day (11 September 2004).** Because a large typhoon had hit Hokkaido and this area was considerably damaged, we were not able to visit the famous Sapporo Botanical Garden at Hokkaido University. Therefore, we went to "Hitujigaoka" (Sheep Hill) where a famous statue of Dr. W.S. Clark is located. There, we enjoyed sightseeing and had very delicious ice cream. Later we drove to "Hanano Nikaido" in Asahikawa to see commercial cyclamen production. The group then traveled to Nature World Hotel at Furano City via "Bieinooka" (Biei Hill; Fig. 1). In a great natural landscape we spent a happy time all night with beer or wine.

**The Third Day (12 September 2004).** In the morning, we visited University Forest in Hokkaido, which belongs to Tokyo University (Address of the University Forest: Yamabe, Furano City, Hokkaido <[www.uf.a.u-tokyo.ac.jp/hokuen/](http://www.uf.a.u-tokyo.ac.jp/hokuen/)>) (Fig. 2). This forest is very large, occupying approximately 20,000 ha; it is also a rare natural forest mixed with broad-leaved trees and evergreen conifers. During our visit to this forest, most of participants were very busy taking pictures and enjoying Hokkaido's natural wonders. Of the many stops on this tour, I guess this stop was the best and most interesting site for our guests. Afterwards, we moved to Kushiro

City as the final stop via large farms in Tokachi Plain. In the evening, of course, we held a goodbye party together with two supporters.

**The Fourth Day (12 September 2004).** During this day, we visited several famous sightseeing spots such as Kushiro Marshland, Fogged Mashu Lake, and Sulfur Mountain. Although the weather conditions on last day were not always good, everybody seemed to enjoy this post-tour.

Lastly, I wish for your continued health, happiness, and second coming to Hokkaido.

## A Plant-Growing Apparatus for Producing CO<sub>2</sub>-Dissolved Water<sup>©</sup>

**Akihisa Minato**

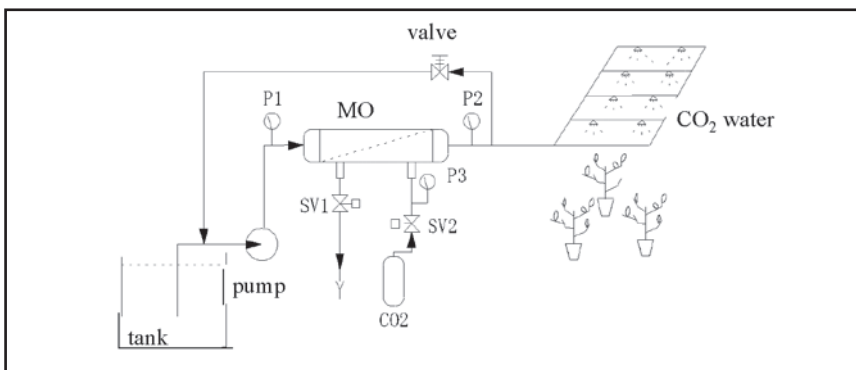
Aquatech Co., Ltd, 1-19 Sansho-cho Nishinomiya, Hyogo 662-0978, Japan

**Takayuki Asada**

Oji Paper Co., Ltd, Forestry Research Institute, 24-9 Nobono-cho Kameyama, Mie 519-0212, Japan

### INTRODUCTION

In this paper, we are introducing a plant-growing apparatus for producing the highly concentrated gas-dissolved water suitable for plant growth (Fig. 1). The plant-growing apparatus is characterized by: (1) a step of supplying CO<sub>2</sub> or O<sub>2</sub> in a pressurized state from one side separated with a permeable membrane (a hollow fiber membrane) that is permeable only to a gas and impermeable to a liquid, while causing water to flow to the other side of the permeable membrane; (2) a step of dissolving the CO<sub>2</sub> or O<sub>2</sub> in the water so as to reach a predetermined concentration in water; and (3) a step of intermittently supplying (atomizing and/or irrigating) CO<sub>2</sub>- or O<sub>2</sub>-dissolved water to plants, thereby promoting plant growth.



**Figure 1.** A view showing an example of plant-growing apparatus in the present paper. The apparatus is roughly made up of, from the upstream side, a water tank, a pressure pump, a hollow fiber membrane module MO, a CO<sub>2</sub> gas cylinder, a control valve SV2, and a relief valve. Operations of the entire apparatus are controlled by a control unit (not shown).

City as the final stop via large farms in Tokachi Plain. In the evening, of course, we held a goodbye party together with two supporters.

**The Fourth Day (12 September 2004).** During this day, we visited several famous sightseeing spots such as Kushiro Marshland, Fogged Mashu Lake, and Sulfur Mountain. Although the weather conditions on last day were not always good, everybody seemed to enjoy this post-tour.

Lastly, I wish for your continued health, happiness, and second coming to Hokkaido.

## A Plant-Growing Apparatus for Producing CO<sub>2</sub>-Dissolved Water<sup>®</sup>

**Akihisa Minato**

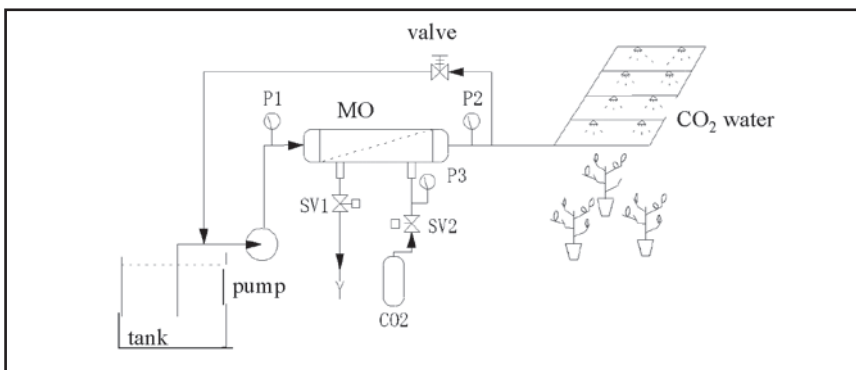
Aquatech Co., Ltd, 1-19 Sansho-cho Nishinomiya, Hyogo 662-0978, Japan

**Takayuki Asada**

Oji Paper Co., Ltd, Forestry Research Institute, 24-9 Nobono-cho Kameyama, Mie 519-0212, Japan

### INTRODUCTION

In this paper, we are introducing a plant-growing apparatus for producing the highly concentrated gas-dissolved water suitable for plant growth (Fig. 1). The plant-growing apparatus is characterized by: (1) a step of supplying CO<sub>2</sub> or O<sub>2</sub> in a pressurized state from one side separated with a permeable membrane (a hollow fiber membrane) that is permeable only to a gas and impermeable to a liquid, while causing water to flow to the other side of the permeable membrane; (2) a step of dissolving the CO<sub>2</sub> or O<sub>2</sub> in the water so as to reach a predetermined concentration in water; and (3) a step of intermittently supplying (atomizing and/or irrigating) CO<sub>2</sub>- or O<sub>2</sub>-dissolved water to plants, thereby promoting plant growth.



**Figure 1.** A view showing an example of plant-growing apparatus in the present paper. The apparatus is roughly made up of, from the upstream side, a water tank, a pressure pump, a hollow fiber membrane module MO, a CO<sub>2</sub> gas cylinder, a control valve SV2, and a relief valve. Operations of the entire apparatus are controlled by a control unit (not shown).

## MATERIALS AND METHODS

Hollow fiber membrane (MHF) (three-layer composite hollow fiber) module was used as the hollow fiber membrane module. Carbon dioxide-dissolved water ( $2,200 \mu\text{mol}\cdot\text{mol}^{-1} \text{CO}_2$ ) was sprayed in mist form onto kenaf (*Hibiscus cannabinus* L.) plants being illuminated with light (light 14 h, dark 10 h,  $24^\circ\text{C}$ ) at intervals of 30 min and for 60 sec at a time during the light period for 47 days. Tap water (as control water) instead of  $\text{CO}_2$ -dissolved water was sprayed in the same way and compared.

## RESULTS AND DISCUSSION

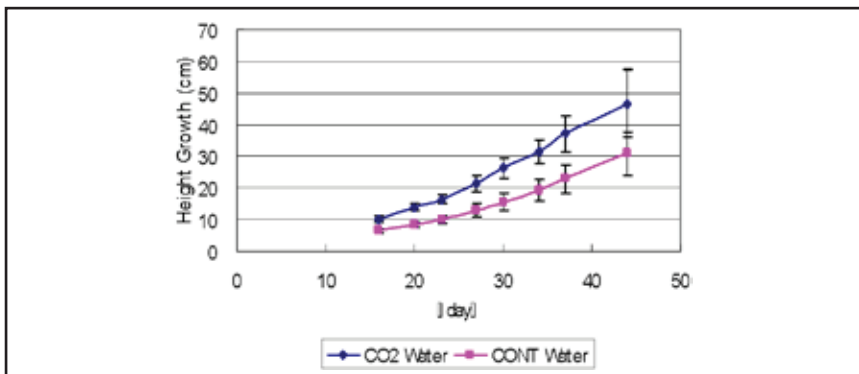
The results are shown in Table 1 and Fig. 2.

The growth of kenaf was promoted when a high concentration of  $\text{CO}_2$ -dissolved water was intermittently atomized onto the plant. Similar results were obtained from  $\text{CO}_2$ -dissolved water irrigation with *Eucalyptus* plants.

The plant-growing method and plant-growing apparatus that use various highly concentrated gases dissolved in water according to the present paper could be applied widely to the fields of agriculture and forestry.

**Table 1.** Effects of  $\text{CO}_2$ -dissolved water ( $2,200 \mu\text{mol}\cdot\text{mol}^{-1} \text{CO}_2$ ) on growth of kenaf (*Hibiscus cannabinus*) on plants sprayed at intervals of 30 min and for a duration of 60 sec at a time during the light period (light 14 h, dark 10 h,  $24^\circ\text{C}$ ) for 47 days ( $n = 10$ , data are the average  $\pm$ SE). SPAD-values were measured with a chlorophyll meter SPAD-502 (Konica Minolta Sensing, Inc. Japan).

Treatment (N = 10)	Dry wt. (g)	Height (cm)	Leaf size (cm)	SPAD
Water (control)	$1.49\pm 0.57$	$30.9\pm 6.9$	$5.7\pm 0.7$	$43.6\pm 6.9$
$\text{CO}_2$ water	$2.86\pm 0.81$	$46.7\pm 10.8$	$7.0\pm 0.7$	$47.4\pm 3.1$
t-test 1% level	**	**	**	



**Figure 2.** Growth curve of kenaf (*Hibiscus cannabinus*) plants sprayed with  $\text{CO}_2$ -dissolved water ( $2,200 \mu\text{mol}\cdot\text{mol}^{-1} \text{CO}_2$ ) and tap water as a control at intervals of 30 min and for a duration of 60 sec at a time during the light period (light 14 h, dark 10 h,  $24^\circ\text{C}$ ) for 47 days ( $n = 10$ , data are the average  $\pm$ SE).

## On the Utilization and Propagation of the Variations Induced by Grafting and Synthetic Artificial Chimera®

Yutaka Hirata, Yuzo Ohta, Gen Hattori, Koji Okayasu, and Yoshi Ohashi

Plant Genetics & Biotechnology Laboratory, Tokyo University of Agriculture & Technology, Fuchu Tokyo 183-8509, Japan

We have obtained genetic changes by using grafting and the synthesis of chimeral plants instead of obtaining transformation by other biotechnological methods (Hirata, 2004). Those results showed the potential available for the induction of genetic changes. In the present study, the phenomena for using graft transformation and chimera synthesis are summarized in pepper, brassica, citrus, and other crops.

### MATERIALS AND METHODS

We adopted the grafting technique with the special “Mentor Method” for genetic variation induction (Yagishita, 1964; Hirata, 1979). For artificial chimera synthesis, in vitro grafting and in vivo methods were applied and were successful in obtaining chimeral plants (Noguchi et al., 1994). Many materials were used for the experiments such as *Capsicum* (pepper), *Lycopersicon esculentum* (tomato), *Glycine max* (soybean), *Brassica taxa*, *Raphanus sativus* (radish), *Brassica napus*, *B. oleracea*, *Citrus*, and others were used depending on the research purpose.

### RESULTS AND DISCUSSION

- 1) Experiments on the graft-induced variation (graft transformation) and the mechanism of the genetic introduction or induction have been done in pepper, eggplant, tomato, and soybean. Genetic variations and new genetic behaviors (irregular changes) were obtained and partially clarified the existence of gene transfer in the vascular system by grafting (Taller et al., 1999).
- 2) Chimera syntheses could be succeeded by in vivo and in vitro graftings. Intervarietal chimera in cabbage, interspecific chimera between *B. rapa* and *B. oleracea*, transgenic *B. napus* and *B. oleracea*, intergeneric chimera between radish and red cabbage, and interspecific *Citrus* chimera have been done. Various interactions between three cell layers that make up the plant were observed at morphological, physiological, and protein and DNA molecular levels. The genetic interaction is a very new finding to become applicable in breeding and gene introduction by using chimera tissue.
- 3) Those interactions and genetic inductions both open new aspects and technology for plant breeding and plant propagation.

### LITERATURE CITED

- Hirata, Y. 1979. Graft-induced changes in eggplant I. Hypocotyl changes in the grafted scion and the selfed progenies derived from the scion grafted on the stock. *Breed. Sci.*, 29:318–323.
- Hirata, Y. 2004. Induction mechanism of cytoplasmic male sterility by artificial chimera synthesis in *Brassica*. *Acta Hort.* 637:303–308.



- Noguchi, T., and Y. Hirata.** 1994. Vegetative and floral characteristics of interspecific *Brassica* chimeras produced by in vitro grafting. *Euphytica* 73:273–280.
- Taller J., N. Yagishita, and Y. Hirata.** 1999. Graft-induced genetic changes and the inheritance of several characteristics in pepper (*Capsicum annuum* L.) *Theor. Appl. Sci.* 97:705–713.
- Yagishita, Y.** 1964. On the induced heritable variation in *Capsicum annuum* L. by means of grafting. *Bull. Fac. General Educ., Tokoyo Univ. Agric. Technol.*, 3:1–48.

# The Role of Training and Education within the U.K. Nursery Stock Industry®

**Leigh Morris**

Head of Education, Royal Botanic Garden Edinburgh, 20A Inverleith Row, Edinburgh EH3 5LR U.K.

## INTRODUCTION

This paper is based on my career experiences within both education and nursery production. It raises issues about the different types of training and education available to the nursery stock industry and highlights why these are fundamental within the I.P.P.S. culture of “Seek and Share.”

Surprisingly, not all within the nursery trade think education is important. It is, however, fundamental in order that nurseries remain up to date and competitive within the ever-changing environment of the modern nursery stock industry. If education is carried out appropriately it can increase both quality and efficiency, motivate and develop staff, and keep businesses up to date with new ideas and technologies.

## CHANGES IN COLLEGE EDUCATION

Traditionally, U.K. nurseries recruited their key staff from graduates of National Certificate and National Diploma programmes from a range of colleges, particularly those with commercial horticulture expertise such as Auchincruive in Ayr, Hadlow in Kent, Pershore in Worcestershire, and Writtle in Essex. However, the quantity and quality of such graduates have declined during the last two decades, and many growers now pass comments that “students are not as good as they used to be” and “colleges are not delivering the same standards of education as they did in the past.”

These comments are, in the main, correct, and comparing a graduate from a National Diploma course in 1990 to one from the same college in 2005 highlights the following facts. The graduate in 1990 would have had a pre-college year and a middle year in employment, plus two spells, each of 2 years, in full-time college. The full-time college year would have consisted of 40 weeks, with the students being in college for 5 days each week (i.e., 400 days over the 2 college years). A graduate from the same course in 2005, however, would have completed no pre-college or middle years. They would still have completed 2 years in full-time education, but a full-time college year in 2005 typically consists of just 30 teaching weeks, with the students being in classes for only 4 days per week (i.e., 240 days over the 2 year course). In effect, a National Diploma graduate in 2005 has had 2 years less industry experience and 160 days less education at college. This makes them less skilled, less knowledgeable, and, consequently, significantly less employable.

There are many reasons for this decline in standards, most of which are due to severe external pressures imposed onto colleges, but the important point is that nurseries must realise these changes have occurred. Then, instead of criticising colleges and their graduates, they must accept that the “product” of colleges has become a different one. Consequently, to ensure the quality of staff they require, nursery owners and managers must take much more of a positive role in the whole education process for themselves and their staff.

## THE ROLE OF FORMAL IN-HOUSE TRAINING

Most nurseries carry out some in-house training, but these are in a range of forms and at various levels. Skilled staff can be trained to “teach,” and offices and/or corners of potting sheds can be converted into makeshift classrooms for workshops and taught sessions. The advantages to nurseries of such in-house training are:

- Training is done when and where the nurseries want it.
- Training can be tailored to the operations of the businesses; staff members are only taught what the nurseries want them to know.
- There is no additional college “padding” such as awarding-body paperwork, registers, and assignments and no qualification “tick boxing,” such as can happen with National Vocational Qualifications (NVQs).

There are examples within many nurseries of staff members who have been employed since leaving school and, over a period of years, have become highly skilled and knowledgeable within the areas of operation of the business. This in-house apprenticeship approach can be very effective, and staff members learn the processes, approaches, and methods specific to the place where they work. One of the disadvantages of this approach, however, is that staff can become “blinkered” into purely the operations of their employer and therefore unlikely to bring new ideas and innovations to the business.

## GETTING THE BEST FROM FORMAL COLLEGE EDUCATION

There are a great many colleges and institutions, including botanic gardens, around the U.K. that offer horticultural training and qualifications. These range from 1-day competency training courses to post-graduate qualifications. Unfortunately, with the demise of specialist national centres for nursery training, colleges can now be very variable in the quality of their programmes, staffing, resources, and approach to education.

It has already been highlighted within this paper that education in colleges is not the same as it was 10 to 15 years ago (certainly not with the mainstream National Certificate, National Diploma, and Higher National Diploma programmes) and the traditional commercial horticulture colleges no longer offer the same specialist commercial nursery courses that they used to offer. Nevertheless, horticulture colleges still have an important part to play in training current and future nursery staff. However, the important thing nursery owners and managers must realise is that colleges have had to change how they deliver, and the “product” is now a different one. Accepting and understanding these changes is vital if growers are to take advantage of what colleges presently deliver.

Even with the changes over recent years, there are still a great many advantages to college-based training and education programmes, including:

- Funding may be available to send staff on the courses.
- Colleges provide knowledge and understanding of the principles of horticulture and plant science, which are seldom delivered within a nursery environment.
- Sending staff to college can add new knowledge and ideas to your business (Fig. 1).
- Courses are delivered by professional, trained, and experienced teachers (of course, this is only a benefit if these teachers ensure their knowledge remains up to date).

- At colleges students/trainees have access to facilities nurseries would not have (Fig. 2).
- College training provides networking opportunities for those attending courses. This gives a different perspective, broadens minds, and again may result in new ideas returning to the nursery.
- College courses provide recognised qualifications/certificates at many levels. This motivates staff and also can be used as part of your “quality” branding.
- Attending college can be seen as a “reward” by staff members who are sent on such programmes.

### THE ROLE OF INFORMAL EDUCATION

There is a range of informal ways in which staff can learn outside formal training courses, but growers should consider whether they currently maximise all the following (and other) varied opportunities for education available to them and their employees.

**Mentoring.** The standard approach is that new staff members are paired up with a more long-serving employee (perhaps a supervisor, but not necessarily), who then acts as a mentor to the new person. It is an approach that can be very successful. Within this role, apart from helping the person settle in and integrate more quickly, it also helps to ensure that the practices and systems are introduced from the first day. The mentor provides the new member of staff with a definite point of contact for queries, and if done correctly, this approach can ensure new employees become effective much sooner.



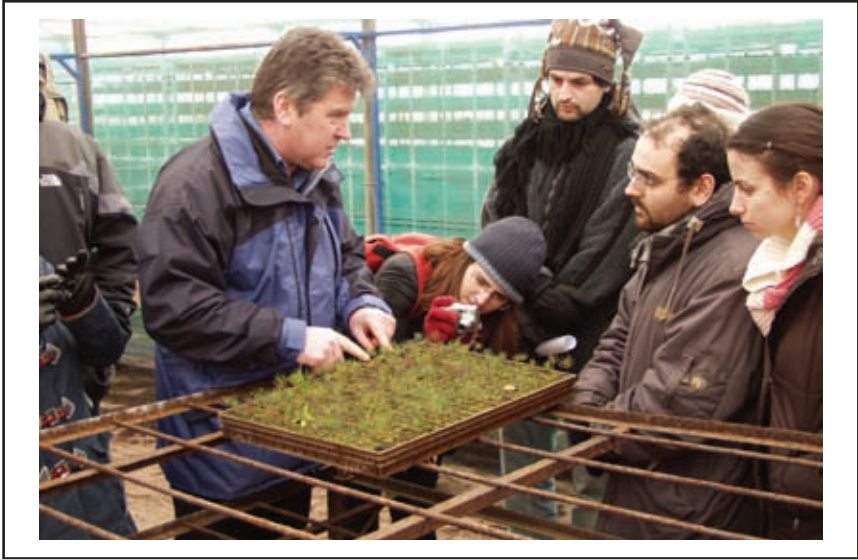
**Figure 1.** Higher National Diploma students being instructed on how to bench graft *Aesculus × carnea* at the Royal Botanic Garden Edinburgh. Such advanced techniques may not be practiced on many nurseries, but the propagation and plant science principles learned are transferable to other areas of nursery production.



**Figure 2.** Nurseries seldom have the range of facilities available at colleges, such as libraries and laboratories. Here a Higher National Diploma student at Edinburgh is using a microscope to view fern spores.

**Books, Journals, and Training Publications.** These are very important resources. Most nurseries, for example, subscribe to a selection of horticultural trade publications, which contain relevant features. But often it is just the owners/managers/supervisors who see these publications; more junior staff should be encouraged to read appropriate articles. This, again, is where a mentoring system can be of benefit, and if keen staff members are encouraged to read and learn, the benefits to the business can be huge. How many nurseries put copies of the journals into the staff mess room as well as in the offices?

**Conferences, Trade Shows, Study Tours, and Seminars.** These are hugely popular events (Figs. 3 and 4). As well as providing fun days out, they are also excellent networking opportunities, and much can be learned from them. Often, though, it is the same staff members who attend most or all the events on offer, and growers should look critically at who would actually benefit the most from specific programmes. Ideally a range of staff would go to different events over the year, and all should have clear aims for their attendance. It is very realistic, even with the most junior employees attending a trade show, to give staff a target for the



**Figure 3.** Visits to look at other nurseries can be an excellent learning experience. Here a group is being shown around Alba Trees, East Lothian, Scotland.



**Figure 4.** Growers viewing compost trials at a Waste and Resources Action Plan open day at the Welsh College of Horticulture.



day: for example to find one product that they feel would help them in their job or improve the nursery where they work. It can also then be a very useful exercise if staff members briefly present a summary of the day at a short team meeting soon afterwards. The important point is that the information from such events needs to be disseminated for maximum benefit.

### **AN INTEGRATED APPROACH TO TRAINING**

In reality there are a great many ways in which nurseries and their staff gain new knowledge and skills. It must be remembered, though, that people learn in different ways. There is no singular "best" approach to education, and ideally a mix of approaches should be adopted. All methods have their merits, and it is recommended that growers question how they train themselves and their staff.

A good approach for large nurseries (or a cooperative of growers) may be to set up bespoke training courses that are delivered in partnership with a horticultural college. This brings together the benefits of colleges, but at the same time ensures that the training is tailored to the specific requirements of the business. It is, however, key that nursery managers/supervisors are involved in the training process from the planning through the actual delivery and assessment. Involving senior staff in this process will help to ensure that the course is tailored specifically to the business and its systems. This will also ensure that, after the training is complete, the skills taught on the course will be assimilated into the nursery ethos and the new ideas sustained.

Another key opportunity would be for nurseries to get involved in initiatives such as post-college training. This is seldom carried out, but when you remember that a National Diploma college graduate is now unlikely to have had any pre- or middle-year experience, the potential benefit of undertaking a 12-month training period after leaving college is clear to see. Taking students on into full-time posts with no practical experience straight from college is a gamble. A fixed 12-month period of post-college training would give nurseries time to properly assess the person, and even if they were not subsequently employed full-time, the skills and experience gained in that year would be invaluable to that person's future employment potential.

It is generally felt to be important that nursery owners/managers increase their involvement with colleges as much as possible. There are many cases of nurseries sending staff to colleges for courses such as day-release training programmes with little or no idea what their staff are actually being taught while they are there or, indeed, who is teaching it. At the end of such programmes trainees are simply expected to be educated and competent, but often they are not. A better approach would be for the supervisor/manager of the trainees to take time to discuss and agree to a joint training plan for each of their staff. Modern Apprenticeships and National Traineeships have tried to instigate such a joined-up approach to staff training, but often this becomes a paper exercise with no real benefits to either party. As part of this process, more nurseries could actually train their supervisors to become instructors/assessors, who would then be able to pass knowledge on to other staff. With such trained supervisors, every day would become an education for the more inexperienced staff.

Another way growers can become more involved and influence education is to become a member of either the board of governors or industrial liaison panel at their local horticultural college. Many colleges are keen to recruit proactive and enthusi-



astic representatives from the horticulture industry onto these panels, and growers are encouraged to make enquiries if they want to become more involved.

A collaborative approach between the industry and colleges produces quality, well-rounded, knowledgeable students, which translates into quality, well rounded, knowledgeable staff.

---

## Preparing for a New Propagation Unit®

**Peter van Delft**

West End Nurseries, Moles Lane, Marldon, Paignton, Devon TQ3 1SY U.K.

### INTRODUCTON

West End Nurseries is a wholesale specialist liner nursery producing a wide range of shrubs and climbers. In 2004, production was 2 million liners, 80% of which was from cuttings and seed, 15% micropropagated plants, and 5% bought-in cuttings or seedlings.

In Year 2000 we had an opportunity to change our business by investing in a new propagation facility. We knew we could not continue trading in the way we had done for previous years. The old propagation unit was highly inefficient, and the site did not lend itself to horticultural redevelopment. We purchased a neighbour's unused tomato nursery that had been redundant for more than 5 years. It included a 1970s 1,920 m<sup>2</sup> Venlo glasshouse with potential to build an additional 2,350 m<sup>2</sup> glasshouse. The purchase of the nursery was in order that West End Nurseries could become as self-sufficient in propagation as possible. It was becoming more difficult to buy in the plants that our customers wanted, and the cost of bought-in material was rising — we felt rising transport costs would only exacerbate this trend. With some competing nurseries abandoning their own propagation units, we felt investment was a good business opportunity enabling us to offer increased reliability to our customers.

### PREPARING FOR A NEW PROPAGATION UNIT

Based on our experience, these are the key steps in drawing up the specifications for a new propagation unit.

#### Preparation.

- Plan effectively and allow sufficient time for all the processes.
- Collect data, including current benchmarks for time/labour costs and your own current costings for production in your existing unit (Table 1).
- Seek information from as wide a variety of sources as possible. It is important to keep an open mind at this stage and view as many other propagation units as necessary. Variation is useful, and we included visits to nurseries in other sectors such as bedding and pot plants. We found other nurseries generally very willing to allow us to visit.
- Visit trade exhibitions (we included those in the U.K. and continental Europe) to obtain information on the current state of the technology in areas such as environment control and handling.

astic representatives from the horticulture industry onto these panels, and growers are encouraged to make enquiries if they want to become more involved.

A collaborative approach between the industry and colleges produces quality, well-rounded, knowledgeable students, which translates into quality, well rounded, knowledgeable staff.

---

## Preparing for a New Propagation Unit<sup>®</sup>

**Peter van Delft**

West End Nurseries, Moles Lane, Marldon, Paignton, Devon TQ3 1SY U.K.

### INTRODUCTON

West End Nurseries is a wholesale specialist liner nursery producing a wide range of shrubs and climbers. In 2004, production was 2 million liners, 80% of which was from cuttings and seed, 15% micropropagated plants, and 5% bought-in cuttings or seedlings.

In Year 2000 we had an opportunity to change our business by investing in a new propagation facility. We knew we could not continue trading in the way we had done for previous years. The old propagation unit was highly inefficient, and the site did not lend itself to horticultural redevelopment. We purchased a neighbour's unused tomato nursery that had been redundant for more than 5 years. It included a 1970s 1,920 m<sup>2</sup> Venlo glasshouse with potential to build an additional 2,350 m<sup>2</sup> glasshouse. The purchase of the nursery was in order that West End Nurseries could become as self-sufficient in propagation as possible. It was becoming more difficult to buy in the plants that our customers wanted, and the cost of bought-in material was rising — we felt rising transport costs would only exacerbate this trend. With some competing nurseries abandoning their own propagation units, we felt investment was a good business opportunity enabling us to offer increased reliability to our customers.

### PREPARING FOR A NEW PROPAGATION UNIT

Based on our experience, these are the key steps in drawing up the specifications for a new propagation unit.

#### Preparation.

- Plan effectively and allow sufficient time for all the processes.
- Collect data, including current benchmarks for time/labour costs and your own current costings for production in your existing unit (Table 1).
- Seek information from as wide a variety of sources as possible. It is important to keep an open mind at this stage and view as many other propagation units as necessary. Variation is useful, and we included visits to nurseries in other sectors such as bedding and pot plants. We found other nurseries generally very willing to allow us to visit.
- Visit trade exhibitions (we included those in the U.K. and continental Europe) to obtain information on the current state of the technology in areas such as environment control and handling.

**Table 1.** Propagation annual comparisons Weeks 18 to 37.

Year	Cuttings produced	Hours spent per operation					Total (h)	Cuttings (h)
		Propagation	Movements	Watering	Plant maintenance			
2001	489,530	5079	962	201	525	6767	72.3	
2002	482,210	5027	818	142	576	6563	73.5	
2003	568,280	5354	268	88	729	6439	88.3	
2004	750,050	6474	244	288	1111	8117	92.4	
2005*	704,125	6132	211	147	592	7082	99.4	

\* Data up to and including Weeks 18–31.

**Establish What You Have.** List all essential features of the current set-up — staff contributions are valuable — and highlight all the unwanted features as a reminder. It is particularly important to collate information about your existing running costs in order to identify how savings can be made. Collate as much data as possible — don't forget to include building maintenance, heating, and lighting. Pay particular attention to costing the labour units in your existing setup; ensure you have systems in place to log inputs into all the various tasks (Table 2).

**Table 2.** West End Nurseries propagation staff time sheet.

NAME	Date 2005				
	Monday	Tuesday	Wednesday	Thursday	Friday
Propagation					
Plastic					
Watering					
Plug Maintenance					
Cutting Movement					
Stock Plants					
Training					
Repairs					
IPM					
Spraying					
Sick					

Then consider the potential facilities available for expansion, for example, relocation to a glasshouse that may be suitable, and identify your current position in the market and what may be available to you — you may end up concluding that buying in is the cheaper option for your particular situation. Throughout the planning process it is vital that you maintain awareness of what is happening in the market around you. Modern trading conditions mean changes are occurring very rapidly and your plans need to be able to respond.

**Establish What You Need.** At West End Nurseries we identified our needs were for improved production flexibility, reduced running costs through use of the latest heating systems, and low maintenance cost through use of up-to-date equipment.

We wanted to produce better quality crops by reducing stress on the propagation material and reducing disease incidence. Higher productivity would be obtained by reducing rooting times and labour input and improving facilities for staff.

In making your plans it is vital to review results from your own or industry- or public-funded research and development that will help you achieve your goals. We were particularly interested in integrated pest management techniques, disease prevention, reduced rooting times, and the effects of rooting environments on plant development.

When making a big investment, it is important to future-proof it as much as possible. We aimed to ensure our new facility would enable us to expand production, make use of future new techniques in plant raising, or explore the potential of new crops and new markets such as plug sales. It is very important to have a facility allowing plenty of flexibility, because it may be necessary to change the crops produced in response to market forces.

It is also vital to build in safeguards through thorough risk assessment: plan contingencies in case of failures of heating, electricity, or computer systems.

**Planning Considerations.** Ensure the terrain is suitable or plan how to deal with any disadvantages. On our new propagation unit we had to arrange for a mechanical lift to move benches between two levels because the site is on a slope. A unit's position within the nursery and access are also important considerations.

Remember that it is all too easy to allow build costs to go out of control. It is sensible to allow for 20% overrun in your costings, but ensure you have control over the build.

Availability of labour resources and key skills can make or break the efficiency of the new unit. Remember that you may need to ask some staff to relocate, work new practices, or learn new skills such as computer techniques and that this may need to be negotiated.

Consider your plant range in relation to the new facilities that will become available in the new unit. There may be potential to expand the range and grow crops that were previously not possible. On the other hand mono-cropping or specialisation may be more efficient. The production opportunities need to be balanced against the risks of overproduction.

## **THE FINAL RESULT: THE NEW PROPAGATION UNIT AT WEST END NURSERIES**

Our plans led to the specifications shown below. The new unit was completed in 2003.

### **Structure.**

- A 2,350 m<sup>2</sup> Venlo glasshouse.
- Thirteen spans, each 9.6 m wide and 5 m tall, one span 6.4 m wide.
- All cladding 1-m-wide glass; venting both sides of ridge.
- Manual internal and electric external doors, 2 m and 3 m wide.

**Heating.** Hot water via 50-mm pipe under the benches spaced in runs 2 m apart. A 40-mm pipe for return flow positioned under the shading. Temperature sensors positioned at strategic points, connected to the environmental control computer.

A 1-million-Btu oil-fired, insulated, aluminium boiler rated at 90% efficiency provides heat. A stand-by iron-section 500,000-Btu boiler is also incorporated into the system and is rated at 65% efficiency.

**Roller Benching.** Benches are 4.3 m long, 1.75 m wide, and made of formed lightweight aluminium with galvanised steel mesh base for drainage and heat access. The bench edges include a machined profile into which the film-plastic sheets used for humidity control can be clipped. Lightweight aluminium hoops with an easy-fitting lock system support the plastic film. We propagate 3,500 to 4,000 cuttings per bench.

**Water Cubicle.** Filled benches are watered in a cubicle from aluminium overhead spray lines controlled by timer or by dispenser into a plastic bench base liner.

**Treatment Cubicle.** Fungicide may be applied to filled benches from a totally enclosed aluminium cubicle via overhead spray lines controlled by timer or through a dispenser.

**Sticking Bench and Cutting Benches.** Sticking bench is height adjustable to  $\pm 30$  cm for operator comfort and optimum work rate. The cutting bench has two operator stations with aluminium worktops sloping away from operators and incorporates a shelf for prepared cuttings. Benches were designed with input from the propagation staff who use them.

**Lift.** A 2000-kg-capacity scissor lift is used to move benches between the two levels of the propagation house.

**Environmental Control Computer.** A weather station monitors wind speed and direction, outside temperature and light levels, and is backed up with Met Office downloads four times per day. The inside climate is monitored for temperature, humidity, and shading. The whole propagation unit is divided into four separate areas with unique environments (two weaning units and two propagation units). The alarm triggers automatic dial-up to 10 people to report any of the failures identified in our risk assessment. Additional software for extra-efficient heating has saved an estimated additional 25% on energy costs.

**Shading.** A 60% thermal shading screen can be supplemented by 20% additional summer shade sprayed onto the glass. We are also equipped with 50% side shading.

**Store Area.** We still work with a small amount of bought-in material. Up to 18 pallets of plug trays can be stored in a cold-store facility at the main entrance to the propagation unit, which includes box-washing facilities.

**Weaning Unit.** Consists of two existing former tomato nursery Venlo glasshouses already on site totaling 1,920 m<sup>2</sup>. Heating is by a 500,000-Btu air heater in each for frost-free protection only. Overhead irrigation incorporates injector for compost tea and liquid fertilizer.

## CONSIDERATIONS AFTER COMPLETION

It can be difficult to consider all the implications of a new build so a review of your unit and circumstances around it may be needed after completion. These may include:

- Effects on neighbouring land in winter and summer.
- Effects on wildlife. We have worked with conservation groups such as the Royal Society for the Protection of Birds to improve habitats

on our surrounding land. Consider new hedge planting or screening both for wildlife and to soften visual impacts.

- Meeting future legislation. Although this should be part of the initial planning process, once the new unit is in operation you may be able to identify ways to make further efficiencies in water recycling, reducing plant waste, material waste, pesticides, energy usage, and other impacts on your local environment.

### LESSONS LEARNED

Even though we planned as carefully as we could, once the new propagation unit was in operation we felt we did make some mistakes:

- Did not allow enough time to learn how to use the new facility before it was commissioned.
- Should have included more storage space.
- Set aside insufficient funds to finish the unit in its entirety.
- Chose incorrect shade levels (75% would be more appropriate).
- In some cases relied too heavily on advice from consultants rather than knowledge from our own experience or our own research.

---

## Advantages of In-House Propagation at Bransford Webbs Plant Company®

**Karl O'Neill**

Bransford Webbs Plant Company, Bransford, Worcestershire, WR6 5JB U.K.

**In 2002–03, Bransford Garden Plants (now Bransford Webbs) needed to make a decision about whether to propagate in-house or buy in plugs and liners, because the old propagation unit had fallen into disrepair. The decision to propagate in-house was made for the following reasons: control of production, introduction of new lines, and to retain skills. The new unit was opened in January 2005 and consists of a 500-m<sup>2</sup> hi-tech mist unit and a 4500-m<sup>2</sup> liner unit, incorporating Eford sand-bed subirrigation.**

### INTRODUCTION

Bransford Nursery was established in 1963, evolving from a traditional fruit, hop, and livestock farm. The company founder, John Tooby, wanted to fully utilise the small number of glasshouses that were only productive for 3 months of the year for hop propagation, so he decided to propagate hardy nursery stock. By the mid 1960s, Bransford was seen as an innovator within the industry and had become an important producer of trees, shrubs, and roses. In the early 1980s Will Tooby became the nursery manager, and the wholesale production of nursery stock had become the core activity of the business. In 1993 the nursery became Bransford Garden Plants, and by 1996 the nursery had drastically reduced its standard A-Z range and become almost a purely promotional nursery. It merged with Webbs Nursery in 2005.

Currently, Bransford Webbs supplies more than 1 million trees, shrubs, roses, climbers, and herbaceous perennials to the garden centre market, of which about

on our surrounding land. Consider new hedge planting or screening both for wildlife and to soften visual impacts.

- Meeting future legislation. Although this should be part of the initial planning process, once the new unit is in operation you may be able to identify ways to make further efficiencies in water recycling, reducing plant waste, material waste, pesticides, energy usage, and other impacts on your local environment.

### LESSONS LEARNED

Even though we planned as carefully as we could, once the new propagation unit was in operation we felt we did make some mistakes:

- Did not allow enough time to learn how to use the new facility before it was commissioned.
- Should have included more storage space.
- Set aside insufficient funds to finish the unit in its entirety.
- Chose incorrect shade levels (75% would be more appropriate).
- In some cases relied too heavily on advice from consultants rather than knowledge from our own experience or our own research.

---

## Advantages of In-House Propagation at Bransford Webbs Plant Company®

**Karl O'Neill**

Bransford Webbs Plant Company, Bransford, Worcestershire, WR6 5JB U.K.

**In 2002–03, Bransford Garden Plants (now Bransford Webbs) needed to make a decision about whether to propagate in-house or buy in plugs and liners, because the old propagation unit had fallen into disrepair. The decision to propagate in-house was made for the following reasons: control of production, introduction of new lines, and to retain skills. The new unit was opened in January 2005 and consists of a 500-m<sup>2</sup> hi-tech mist unit and a 4500-m<sup>2</sup> liner unit, incorporating Eford sand-bed subirrigation.**

### INTRODUCTION

Bransford Nursery was established in 1963, evolving from a traditional fruit, hop, and livestock farm. The company founder, John Tooby, wanted to fully utilise the small number of glasshouses that were only productive for 3 months of the year for hop propagation, so he decided to propagate hardy nursery stock. By the mid 1960s, Bransford was seen as an innovator within the industry and had become an important producer of trees, shrubs, and roses. In the early 1980s Will Tooby became the nursery manager, and the wholesale production of nursery stock had become the core activity of the business. In 1993 the nursery became Bransford Garden Plants, and by 1996 the nursery had drastically reduced its standard A-Z range and become almost a purely promotional nursery. It merged with Webbs Nursery in 2005.

Currently, Bransford Webbs supplies more than 1 million trees, shrubs, roses, climbers, and herbaceous perennials to the garden centre market, of which about



40% is propagated in-house. The nursery now specialises in new plants and operates an extensive research and development unit. This has strengthened the company's differentiation within the industry. New lines tend to be produced in large numbers, with batches ranging from 5,000 to 30,000, which has improved efficiency in production. The speed at which these new lines can be introduced is vital to gain a foothold in the market. Therefore there is a lot of pressure on the propagation unit to produce these new lines successfully.

The old propagation unit had been in place for many years and was no more than a collection of old dilapidated glasshouses, which were used to house the mist units, together with polytunnels for liner production. The unit as a whole, especially the propagation houses, had fallen into disrepair, and renovation was not a viable option. Another major problem with the old unit was that it limited the range of crops that could be grown: grey-leaved plants such as *Lavandula* and *Leptospermum* proved difficult to grow, with poor rooting conditions and unsuitable irrigation in the liner unit.

### **FACTORS IN THE DECISION TO INVEST IN PROPAGATION**

The idea of developing a new propagation unit had been discussed by nursery managers since the early 1990s. In 1992, plans were drawn up and planning permission was granted. These plans initially had to be put on hold because there was insufficient capital. However, after a couple of very successful trading years in 2002 and 2003, the funds finally become available, and this left Bransford with a decision to make. There were two alternatives: invest heavily (approximately £250,000) in a new propagation facility, or phase out in-house propagation totally, contract-out all plug and liner production to young plant suppliers, and become a finishing nursery. The following factors were considered:

**Advantages of Propagating In-House.** An in-house propagation unit, in conjunction with the research and development unit, enables close control over new introductions and helps gain exclusivity on certain lines, thus differentiating the nursery from its competitors and generating added value. Advantages include:

- Gives ability to control production quality, programming, and flexibility from propagation through to sale.
- Crop failures are identified early.
- Reduced risk of being let down by suppliers on quality and quantity.
- Keeps skills within the business and makes the nursery a more attractive proposition to prospective new employees, especially apprentices and trainees.
- Our costings showed that the cost of producing of a 9-cm liner in-house is 55p. Whereas on average, the cost of a bought-in liner is 75p.

### **Advantages of Buying in.**

- Cost of investment in facilities and staff present a risk.
- Wider supply choice: if an individual supplier fails to meet your requirements you can look elsewhere, but with an in-house propagation unit, there has to be a return on the investment.
- Simplified production schedules.
- Specialist nurseries may have more experience with producing difficult-to-grow crops to a high quality and may have more suitable

facilities. For example, Bransford does not have the correct water type to grow a wide range of ericaceous plants.

The longer a working relationship can be built up with a supplier, the better the service becomes, priority can be gained, and supply tailored to the nursery production schedule.

If production targets are reduced or even dropped, orders can be cancelled right up until the delivery date or up to an agreed timescale with a supplier. With in-house propagation a lot of work has already been carried out, and crops may have been in production for 12 months or more including sourcing stock plants.

### **BRANSFORD'S NEW PROPAGATION AND LINER UNIT**

Having looked at the factors listed above, Bransford Garden Plants' managers decided in 2003 to invest in a new propagation unit. A key reason was that, as a predominantly promotional nursery, new introductions are seen as the lifeblood of the business, so the control that an in-house propagation unit, incorporating research and development, gives is essential to the future of the company.

The plans drawn up in 1992 were updated after further research into propagation unit construction methods. Construction began in spring 2004 on a new hi-tech unit covered with 5000 m<sup>2</sup> of glass, incorporating a 500-m<sup>2</sup> mist unit and 4500-m<sup>2</sup> liner unit, subirrigated with Efford sand beds. Construction was completed by January 2005, at a cost of approximately £250,000. External contractors undertook the glasshouse construction and installation of heaters, boiler system, and the Tom-Tec environmental control computer system. However, the sand beds, the mist unit, and the concrete roadways were all installed by the maintenance and nursery staff at Bransford, which helped to control costs.

Currently the company still purchases up to 60% of its young plant requirements because many of the crops grown are specialist and with many others there are licensing regulations that prevent propagation. However, over the next few years we expect to increase in-house propagation to approximately 75% of our requirements as a result of access to the more sophisticated propagation facility now in place.

**Acknowledgement.** With thanks to all my colleagues at Bransford Garden Plants who contributed in writing this paper.

# Developments in the Supply Chain of Hardy Ornamental Nursery Stock for the Retail Market: A Finished Plant Grower's Perspective<sup>®</sup>

**Alastair Hazell**

Darby Nursery Stock Ltd, Methwold, Thetford, Norfolk IP26 5NN U.K.

## INTRODUCTION

Darby Nursery Stock is a large wholesale nursery producing container-grown hardy nursery stock entirely for the retail market. Production started 36 years ago, and the nursery has increased in size as the U.K. garden centre market has expanded. The nursery grows a wide range of plants although specializing in *Lavandula*, container-grown trees, climbers, and soft fruit.

Recent changes in market requirements have led to the introduction of several promotion crops, mainly herbaceous perennials such as *Salvia* × *sylvestris* 'Rhapsody in Blue', *Sidalcea* 'Little Princess', *Verbascum* 'Pink Kisses', and *Veronica* 'Ulster Blue Dwarf'. The introduction of these promotion crops has in part created a change in the nursery's propagation, production, and plant buying systems.

Until recently the nursery propagated approximately 90% of its own material. The propagation department uses mist to root semi-ripe cuttings, most of which are propagated in 3.5-cm cell trays. This department has rooted more than 4 million cuttings in a single season. Generally the plugs are potted into a liner pot and then grown on for another season before being potted on into the saleable pot size.

The 10% of production that was traditionally out-sourced was purchased for one of two reasons: (1) To make up for any short-falls in our own propagation/production; or (2) To obtain material from other nurseries that specialised in a certain type of production or crop (for example, open-ground bare-root material such as maiden trees or difficult-to-root plants such as hybrid clematis).

## CHANGES IN THE SUPPLY OF PLANT MATERIAL

In the last 5 years, the number of nurseries supplying plants to Darby Nursery Stock Ltd. has increased from 8 to 38 while its own propagation has decreased to approximately 70% of all plants sold. There are several reasons for this.

**Increased Production of Promotional Crops.** The most effective promotions have to be available in reasonable numbers in a short period of time. The nursery is not equipped to rapidly bulk-up such plants. In addition, most of these crops are only available from a limited number of suppliers who also control the propagation rights. Several of these crops are herbaceous, in which the nursery has little propagation experience; therefore, to ensure uniform production, it is better to buy in from another nursery that has an expertise in growing them.

**Increased Use of Specialist Plant Propagators.** Sometimes these suppliers are growers who concentrate on a limited range of crops. This enables them to improve all aspects of production including manipulation of stock plants to produce high quality uniform cutting material; ensuring that the rooting, weaning, and growing environments are conducive for good growth — and good control of pest and disease

programmes, thus avoiding transferring any problems. Because of this specialisation these propagators can often offer their plants in a range of plug and liner sizes and at different times during the season. This helps with crop scheduling.

The other group of plant propagators used grow a wider range of plants, but because of their size, they can offer material at competitive prices. Their range of customers (supplying nurseries growing for both the landscape and retail sectors) means that they can grow large numbers of popular plants. This reduces their costs and enables them to offer available stock from availability lists. They also offer different plug and liner sizes as well as jumbo multi-stuck plugs.

When growing plants for the large retail groups there is pressure to reduce production costs. By using several plugs, or one large multi-stuck plug, potted straight into the saleable pot, there is a reduction in the input costs as well as reducing the production time. This enables the nursery to be more flexible in an ever-changing market.

## FUTURE DEVELOPMENTS

The globalisation of plant production will create more opportunities for plant purchasing. Plant material now comes from several places both in Europe and further afield. Last season Darby Nursery Stock bought plant material from nine different countries, some as far away as Japan and New Zealand. Foreign production enables plants to be propagated in ideal conditions (such as *Lavandula* from Israel) as well as utilising reduced labour costs (such as multi-stuck *Hedera* and *Euonymus* from Poland). Plugs are high-value, low-weight items, and propagation might be carried out even further afield such as in Africa or China in the future.

Specialist propagators who concentrate on a limited range of plants will increase their use of automation. Already robotic transplanters (in pot and bedding production) are being used. Some growers have started to use the plug-to-plug systems that enable small plugs to be automatically transplanted into larger, liner-size plugs. This large plug can then also be automatically transplanted to the final saleable-size pot. This reduces the labour costs throughout the production cycle as well as helping to improve uniformity of production.

Recent poor trading within the general retail market in the U.K. has caused a downturn in the demand for garden plants, thus leading to a certain amount of over-production. This, together with changes in the demand for certain shrubby species, has meant that liner growers are reducing the amount of material propagated and offered on availability lists: more crops are now being grown on a contract basis.

**The Future for Propagation at Darby Nursery Stock.** In the future, Darby Nursery Stock will have to make the decision whether to carry on with its own in-house propagation. Department overheads will need to be reduced if the nursery continues with its own propagation. This can be done by only rooting subjects that have a high percentage take. In addition, propagation and liner departments could be merged and run as one. A liner department might be needed, even if all plants are out-sourced, because this enables a greater control of the supply chain. Having a pool of labour within a propagation-liner department might also indirectly help with peaks in despatch, because this labour can be used without creating too many problems to general production. While this is not a sound reason in isolation for retaining a propagation facility, it must not be totally forgotten as a factor. The ability to

maximise sales in times when demand is strongest will become even more crucial—and there are few alternative sources of competent people with sufficient prior knowledge to be of value to uplift despatch volume in peak weeks.

### **MANAGEMENT OF PLANT PURCHASES**

Good communication is the key. Before we start placing orders, the previous season's plant purchases are reviewed. Information on quality, timing, and price of the input material is gathered together. Then plant wastage and total sales are considered. This information gives us the ability to talk to our suppliers to improve supply if needed. An assessment on total requirements is made, and then the order can be placed.

Specifying certain attributes of the crop is becoming increasingly important because multiple retailers now work to a set specification for their finished plants. Height and number of breaks can be noted at the ordering stage — with multi-stuck plugs the number of cuttings per plug and plug size has to be noted.

Feedback from the supplier is important at all stages of production. Can they achieve the requested specification? What implications does the specification have on price and delivery time? If the plants are failing to reach the specification, we need to know as early as possible. We might then decide to either replace the material from another supplier or accept the lower specification plants. Today this has become easier with the use of digital photography and e-mail.

With tight delivery windows for finished plants, the timing of delivery is also important. We work through each order to achieve our time schedule and make-up sensible delivery quantities for the supplier. Once again it is important to know about any delays that might occur during production. Unfortunately late deliveries might cause a reduction in the numbers of plants needed or even a cancellation of the order.

The plant types, numbers on each delivery, and their source are communicated on a weekly basis to the relevant members of staff. The nursery only accepts deliveries Monday to Wednesday to avoid any problems with plants turning up on Friday afternoon and then having to be held on trolleys over the weekend. The numbers are counted and cross-checked with the delivery note as well as a health check being carried out before the plants can be potted on. We try to communicate any problems with quality, numbers, or pests and diseases with the supplier within 24 h of delivery.

## The Role of Propagation in a Small Specialist Nursery®

Irene Bowron

MacGregors Plants for Shade, Carters Clay Rd., Lockerley, Romsey, Hants SO51 0GL U.K.

**When MacGregors Plants for Shade was set up as a small specialist nursery business, in-house propagation was the preferred method of production. External and internal factors led to a change in this policy and a greater reliance on purchased young stock. A recent review of the business resulted in a return to more in-house propagation.**

### ESTABLISHING THE NURSERY

MacGregors Plants for Shade was set up 10 years ago by its two partners as a small nursery business to fill what was seen as a gap in the specialist market. There was a need for plants for shade areas, and we aimed to supply a market consisting of amateur gardeners, professional garden designers, and small landscape businesses. Our market research resulted in a plant list designed to offer a wider and more unusual range of plants that could be grown in shade conditions.

From the beginning, we decided to control pests and disease using biological methods and established integrated crop management, with the support of company specialists, in three protected structures. Spraying with compatible crop-protection chemicals was kept to a minimum. Integrated crop management was used from the propagation stage through to the finished plant stage. The only exception to this was the inclusion of vine weevil control in the compost, a specified, general purpose, peat-reduced mix, which contained a percentage of loam and bark.

At the beginning the plant list was quite diverse, but with time and experience, it became clear that a more focused list was required. We found that our plants fell into one of three categories: plants that required full shade, those that required part shade, and those that performed best in light or dappled shade. We recognised the section of the list that gave most opportunity for innovation and experimentation with suitable plants was that defined by part shade.

Because of the scale of the enterprise, we only propagated in small batches. Propagation techniques were varied, and we judged success by the quality of the finished plant rather than the volumes we produced. We built a series of propagation facilities to provide for division, cuttings, and seed sowing. Plant types included shrubs, herbaceous perennials, ferns, grasses, and bulbous plants. Most of the propagation material was generated on site either from stock plants maintained for propagation or, where appropriate, material and seed from plants that remained unsold.

We bought-in as young plants only a relatively small proportion of our needs. As a general rule, this was only to fill sales requirements that could not be met by in-house propagation; for example, when crops failed, when advance sales commitments could not be met, or when it was more economic to buy in for plant range, as in the case of ferns.

### DEVELOPING THE NURSERY

Over the next 7 or 8 years, sales showed a steady increase with the main selling season from March to June and further sales from September to November. Outlets

were determined by the specialist nature of the plant list and the size of the enterprise. They included other specialist nurseries, garden designers, small landscape gardening enterprises, and specialist plant sales events. The nursery was open to the public, and plants were regularly sold from the site.

An ongoing programme of lectures to horticultural and other related societies generated useful additional income during the winter. It also provided an opportunity to extend sales and introduce less well-known plants to groups of people willing to experiment with them.

Since one of the nursery partners had a background in education, contacts established with local colleges and other related organisations created additional opportunities for the nursery and provided a platform for continued education and support for the business itself.

We decided that part-time staff would be required to support further expansion. However, before this could be implemented, several successive external events caused a downturn in the plant market, which was reflected in our sales. Employing staff was no longer a short-term option.

Instead, we decided to extend the selling season, reduce the amount of in-house propagation, and increase the number of bought-in young plants. The extra time this made available would be used to increase marketing and sales. This had an overall benefit, but created other difficulties that only became apparent in the longer term. The plant list became more general and less competitive and lost its specialist identity. As in-house propagation decreased, it was becoming increasingly difficult to maintain a reliable source of young, less well-known plants that could be finished and offered for sale at a reasonable profit. Specialist plants did not generally have "impulse buy" impact, and as a small enterprise, it was not possible to gain from the benefit of scale both in terms of production and markets.

The horticultural industry and wider society had both changed, and we realised that it was time to re-evaluate the business in relation to current issues of environment, climate change, land use, competition, globalisation, specialisation, and lifestyle.

## **RE-EVALUATING THE NURSERY**

We developed a new framework for the business over a period of time. We decided to consider plant production in relation to the whole site rather than just the nursery area. Growth was ring-fenced, production and sales contained, and we decided not to employ any staff. We re-focused the plant list back to predominantly plants for shade, with a higher proportion of the less well-known taxa. Volume sales were replaced by fewer but higher-value sales. Instead of purchasing young plants, we sourced stock plants from wider and more varied sources, which were then propagated in-house. Production became plant-based rather than commodity based.

## **THE PRESENT NURSERY AND CURRENT ISSUES**

Although the nursery was only set up 10 years ago, it has developed against a background of rapid, significant, and in some cases irreversible change. Even a small business has to respond to developing local, national, and international issues.

**The Environment, Climate Change, and Land Use.** We now run the nursery as part of an environmental site. The whole area is surrounded by farmland and ideally situated for biodiversity enhancement. Native hedging has been planted and



areas of long grass and weeds managed to provide a reservoir for wildlife including natural predators. These should help to maintain a site pest/predator balance and help integrated crop management in the protected structures.

The effects of changing weather patterns cannot be ignored. Problems of local drought, late frosts, and widely fluctuating temperatures are increasing. The plant list has been modified to take account of site limitations. Generally, we now grow only those plants that can be successfully produced and maintained with little or no protection. Heating is restricted to propagation units only.

Tunnel use has become less intensive, with other areas of the site being used for production. Stock plants are maintained throughout the site, and we make better use of outbuildings for seed sowing, potting, and propagation. Water use is also under review, with greater emphasis on methods of conservation. No doubt difficulties will arise in the longer term, but we hope that better use of the site's assets will lead to a more economic production of good quality, healthy, robust plants that transfer well into customers' gardens.

**Competition and Globalisation.** The nursery, as set up, cannot compete in the mass markets. There is a place for intensive plant production that uses the benefits of scale, but this requires a much greater financial input, reliance on technology, and commitment to marketing, sales, and competition. MacGregors Plants for Shade has made its primary focus a much smaller and specialist market with a plant list that does not lend itself to large-scale production. This does not invalidate other markets or production methods. It simply fills a specialist niche using relevant methods of production to which in-house propagation is fundamental.

A greater selection of less common stock plants can be obtained economically in small numbers from a wide range of sources. By propagating these in-house, it makes far better use of existing assets in the form of the propagator's skills and propagation equipment. Effective and economic propagation also requires in-depth knowledge of plants, including structure, growth patterns, and natural habitats. Even if only small batches of plants are produced, there is no room for ineffective and wasteful propagation. Indeed, in the smaller enterprise, there is even less room for failure.

**Specialisation and Diversification.** Specialisation has been the nursery's strength and weakness. Clearly there is a market for specialist plants, but it is restricted by its very nature. We have put considerable effort into marketing, and here the Internet has an important role to play. However, there are no benefits of scale with regard to overheads and production cost. There are difficulties in economic acquisition and propagation of specialist plants. A greater proportion of in-house propagation does address the problem, but continuity can be difficult to achieve.

Like farming, running a nursery is a way of life, a chosen lifestyle. While plants themselves can be produced economically within a small enterprise, the lack of size cannot support overheads and growth. If the chosen lifestyle is to be maintained, then other methods of supporting overheads and growth have to be found, increasingly through diversification. The small specialist business can then focus on aspects of growing that can be of benefit to the nursery industry as a whole, but which are not necessarily measured in terms of financial success:

- The practice and maintenance of diverse propagation skills used in a wide and varied range of small-scale production.
- The passing on of those skills through education, training, and sharing.

- The introduction and promotion of a range of less well-known plants to a wider customer base.
- The trialling and assessment of a range of plants that could be recommended for the needs of the specialist buyer.
- The production of plants as part of an environmental management programme for the whole site.

Small specialist nurseries should not have to compromise on professionalism or quality in order to succeed. Diversification is one possible route that can be taken and explored in greater detail in order to maintain a position in this small but important part of the industry.

---

## **The Development of Sustainable Growing Media Components from Composted Specific Bio-Waste Streams®**

### **N. Bragg**

Bulrush Horticulture Ltd, Newferry Road, Bellaghy, Magherafelt, Co Derry, BT45 8ND, Northern Ireland

### **T.F. Brocklehurst, A.C. Smith, M. Bhat, and K.W. Waldron**

Institute of Food Research, Norwich Research Park, Colney, Norwich NR4 7UA, U.K.

**This paper describes a feasibility study into the preservation of plant structural remains, which can then be used as components of growing media for containerised plant production. The drivers for the work are both the need to use bio-waste streams rather than disposing of them to landfill and the need to find long-term sustainable components for growing media that have properties as beneficial as the peats currently used.**

### **INTRODUCTION**

Currently within the U.K. there are specific drivers that are challenging the use of traditional components of growing media used for container-grown plants on nurseries. The drivers for change come from a number of directions: E.U. directives on wetland habitat protection — and hence the desire to reduce the use of peats in growing media; E.U. directives to reduce the amount of compostable material going to landfill and finding alternative markets for the composted material; major retailer pressure to reduce reliance on the peat component of growing media in order to achieve national government aspiration targets for peat reduction and to reduce the impact of environmental lobbyists on the public perception of their business ethics.

In order to try to find suitable alternative components to the use of peats in growing media, attention has been focused on the use of composted materials. The process of composting materials in an aerobic fashion has been reviewed by many authors, for example, Lopez-Real (1990). The natural process is basically one in which various phases of degradation can be identified. The phases are characterised by changes in temperature of the decomposing mass, which relate to changes in micro-

- The introduction and promotion of a range of less well-known plants to a wider customer base.
- The trialling and assessment of a range of plants that could be recommended for the needs of the specialist buyer.
- The production of plants as part of an environmental management programme for the whole site.

Small specialist nurseries should not have to compromise on professionalism or quality in order to succeed. Diversification is one possible route that can be taken and explored in greater detail in order to maintain a position in this small but important part of the industry.

---

## **The Development of Sustainable Growing Media Components from Composted Specific Bio-Waste Streams®**

**N. Bragg**

Bulrush Horticulture Ltd, Newferry Road, Bellaghy, Magherafelt, Co Derry, BT45 8ND,  
Northern Ireland

**T.F. Brocklehurst, A.C. Smith, M. Bhat, and K.W. Waldron**

Institute of Food Research, Norwich Research Park, Colney, Norwich NR4 7UA, U.K.

**This paper describes a feasibility study into the preservation of plant structural remains, which can then be used as components of growing media for containerised plant production. The drivers for the work are both the need to use bio-waste streams rather than disposing of them to landfill and the need to find long-term sustainable components for growing media that have properties as beneficial as the peats currently used.**

### **INTRODUCTION**

Currently within the U.K. there are specific drivers that are challenging the use of traditional components of growing media used for container-grown plants on nurseries. The drivers for change come from a number of directions: E.U. directives on wetland habitat protection — and hence the desire to reduce the use of peats in growing media; E.U. directives to reduce the amount of compostable material going to landfill and finding alternative markets for the composted material; major retailer pressure to reduce reliance on the peat component of growing media in order to achieve national government aspiration targets for peat reduction and to reduce the impact of environmental lobbyists on the public perception of their business ethics.

In order to try to find suitable alternative components to the use of peats in growing media, attention has been focused on the use of composted materials. The process of composting materials in an aerobic fashion has been reviewed by many authors, for example, Lopez-Real (1990). The natural process is basically one in which various phases of degradation can be identified. The phases are characterised by changes in temperature of the decomposing mass, which relate to changes in micro-

bial population, which in turn relate to the breakdown components of the mass at any one time. The end result of a well-aerated composting process can be shown to consist of any mineral particles originally present in the material and clumps of microorganisms. The original structural nature of the materials placed in the compost process is often completely lost.

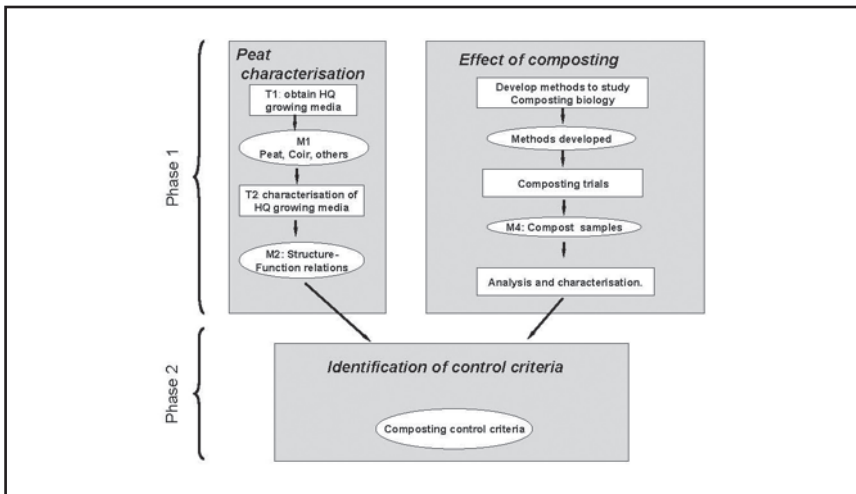
Conversely, when peats are exhumed and examined it is quite evident that the physical structure of the plant remains that entered into the mire are maintained. The fact that the plant structural remains have in some way been preserved in the mire gives peats the specific properties that make them ideal for use as components of containerised growing media.

The challenge of the work described here is to identify the components of the plant structures within peats that give them their functionality in growing media, then to emulate this functionality via the aerobic composting process. This might involve either stopping the normal processes that occur or altering the conditions to maintain the structure of the plant material throughout the process.

## MATERIALS AND METHODS

The work program for this project is shown in Fig. 1.

Phase one of the work has two components: first the characterisation of peats to identify the components that confer functionality as growing media and, second, a parallel study of various aerobic compost mixes from selected food and agricultural bio-waste streams (non-animal waste) to fully characterise the processes and changes in structural nature of the mixes throughout the natural aerobic composting phases. The selection of materials for use in the composting study has been governed by the need to have long-term access to bio-waste streams of consistent type, in large quantities, and with good traceability.



**Figure 1.** Overview of feasibility project.

Phase 2 of the work draws together the experimental data from Phase 1 and is designed to produce a model system that uses the normal aerobic composting process to tailor the structural nature of the plant remains and hence produce a

well defined, structurally sound material from the normal composting process. This again is drawn together in Fig. 1.

## RESULTS AND DISCUSSION

At the time of writing this paper the work programme, which is sponsored by the U.K. Government Department for Environment, Food, and Rural Affairs (Defra) under the LINK programme, is approximately halfway through the initial feasibility study period. The project partners are acknowledged below. Phases 1 and 2, indicated in Fig. 1, are well progressed, and an initial batch of material from one of the compost treatments has been identified as having preserved structural composition, which is considered to be a considerable step forward from the normal end product of the composting process. Germination trials (using French marigold Dwarf Double Mixed™) have been undertaken using the newly produced material as a component of a growing medium, and the initial results in terms of growth are extremely good.

As a result of the initial findings, further mixes of the components have been set up and the aerobic composting is being monitored and sampled to replicate the material previously identified for further and more extensive trials.

In addition, further grant applications are being made to develop both the process control aspects of the work and also to fully exploit the potential of the findings of the feasibility study. A further feasibility project for this aspect of the work has recently received a grant from the U.K. Government Department of Trade and Industry Zero Emissions Enterprise Scheme.

**Acknowledgements.** The work described in this paper was funded by a U.K. Defra Hort-LINK feasibility project (project no. HL0172). The authors wish to acknowledge the research activities of Z. Merali, G.K. Moates, and Jeanette Newman and active collaboration with the following project partners: Organic Recycling Ltd., Swedeponic U.K. Ltd., Farplants Sales Ltd., Scottish Courage Ltd., Delmonte Fresh Produce U.K. Ltd., Horticultural Development Council, and The Composting Association.

## LITERATURE CITED

**Lopez-Real, J.** 1990. Agro-industrial waste composting and its agricultural significance. The Fertilizer Soc. London, Proc. No. 293.

# Influence of Rooting Media in Cuttings Propagation of *Caryopteris* × *cladonensis* ‘Persshore Jubilee’, *Rosmarinus officinalis* ‘Tuscan Blue’, *Fuchsia magellanica* var. *molinae* ‘Sharpitor’, and *Abeliophyllum distichum*®

Suzanne O’Neill

Avonbank Nurseries, Pershore College, Avonbank, Pershore, Worcestershire, WR10 3JP U.K.

The paper describes a nursery trial that aimed to ascertain the best medium for rooting and whether a peat-free medium had any significant influence on rooting. Softwood cuttings of four different plants were stuck in seven different media. The trial was replicated in the main nursery mist unit and Specialist Plant Unit (SPU) mist house. There was very little difference between rooting in each medium for each of these plants. Other factors are therefore more important when choosing a suitable medium, such as supply, cost, shelf life, and ease of handling.

## INTRODUCTION

Avonbank Nurseries consists of two areas, the main nursery and the Specialist Plant Unit (SPU). The SPU has been using peat-free growing media successfully for the last 3 years. The main nursery uses both peat-based and peat-free media. It is reducing its peat use and trialling peat-free media. However, a few technical problems have arisen, including an inability to incorporate the pesticide Intercept™ (imidacloprid) and supply problems.

There are two propagation units on the site. The propagation unit on the main nursery is a 192 m<sup>2</sup> polytunnel with four low, heated beds with mist controlled by electronic leaf and a further four low, heated beds used for rooting silver-leaved plants and for weaning. The SPU propagation facility is also a mist unit, but is an 84-m<sup>2</sup> glasshouse with three beds at waist height. The differences in the set up of each mist unit results in two different environments being created.

The plants chosen for this trial were *Caryopteris* × *cladonensis* ‘Persshore Jubilee’ (easy to root), *Rosmarinus* ‘Tuscan Blue’ and *Fuchsia magellanica* var. *molinae* ‘Sharpitor’ (fairly easy to root), and *Abeliophyllum distichum* (more difficult to root).

Seven different media were used. Both Ellepots and a peat/bark/perlite mix are used for propagation on the main nursery. The SPU has replaced a 1 peat : 1 bark (v/v) mix with peat-free compost. Geo Pots, Fertil plugs, and Humax were also included in the trial.

In addition to rooting success, there are other factors to consider when choosing a suitable rooting medium. There has been a shift from nurseries mixing their own compost and using modular trays, to preformed plugs being used, and there are a number of different plugs on the market. Plugs are easier to handle and quicker to prepare, as well as being easier to pot on. The plugs generally come out of the tray effortlessly, without disturbing the roots avoiding loss of rootball.

The cost, ease of ordering, and reliability of supply are also important commercial considerations. Certain kinds of plug trays can only be bought in large numbers

and have a limited shelf life. For some nurseries this could be a problem. For example, Ellepots must be used within 3 months of purchase; self-mixed media may contain controlled-release fertiliser, which has a specific life.

**Table 1.** Ingredients of trial media.

Medium	Bulk Ingredients
Geo Pot™	Peat-based plug
Fertil Plug	4 wood fibre : 1 peat (v/v)
Ellepots™	Peat-based plug (exact contents unknown)
Peat/bark mix	1 peat : 1 bark (v/v)
Peat/bark/perlite mix	2 peat : 1 bark : 1 perlite (v/v)
Peat-free mix	1 Sylvamix (composted forestry residues) : 1 bark (v/v)
Humax™	Peat and silver sand blend

## METHODS

The trial began on 20 April 2005. The trays were prepared, and uniform softwood cuttings taken from the chosen plants. As this trial was a grower trial rather than a scientific trial, large numbers of replicates were not used. Eleven cuttings of each plant were placed into each medium, totalling 44 cuttings in each tray. The trays were laid out in the same way each time: *Rosmarinus* 'Tuscan Blue' was placed into the first two rows, two rows were left empty, and then *Fuchsia* 'Sharptior' was placed in the next two rows, and so on. The trial was replicated in slightly different environmental conditions: one set of trays was placed in the main nursery mist unit and one in the SPU mist unit.

Two weeks before the end of the trial, the trays were moved onto a drier bed within the mist unit for weaning.

The results were recorded after 7 weeks on 8 June 2005. The cuttings were eased out of the trays, and the roots were scored on a scale of 0 to 5 as follows: 0 = Dead, 1 = Callus, 2 = Very few roots, 3 = Rooted, 4 = Well rooted, roots can be seen at the edge of the plug, 5 = Entire plug rooted and extending out of plug.

## RESULTS AND DISCUSSION

Rooting results are shown in Table 2.

The media presented as plug trays were easier and quicker to prepare. However, if they were slightly dry, it was difficult to stick the cuttings without damaging them. Modular trays of loose media took longer to prepare because they needed to be filled and wetted before use. This was not a major issue during a small trial. However, in a commercial situation, when a large number of trays are needed, modular tray preparation can take a considerable length of time and may even require an extra employee to complete this task.

When removing the plants from the trays the plugs were much easier to handle and would have been quicker to pot into liners. Unless the cuttings had rooted especially well, a lot of compost fell away from the roots of the cuttings in modular trays. This was especially the case with the peat-free compost and the 1 peat : 1 bark (v/v) mix, making the roots quite vulnerable for potting.



**Table 2.** The root scores of plant for both units and in all media.

Plant/unit	Media used						
	Geo pot	Fertil plug	Elle pot	Peat/bark	Peat/bark /perlite	Peat free	Humax
<i>Caryopteris</i> Main Nursery	4	5	5	4	4	4	4
<i>Caryopteris</i> SPU	5	5	5	5	5	5	5
<i>Rosmarinus</i> Main Nursery	3	5	4	4	4	3	3
<i>Rosmarinus</i> SPU	4	5	5	5	5	4	4
<i>Fuchsia</i> Main Nursery	3	3	3	2	3	2	2
<i>Fuchsia</i> SPU	4	4	4	3	3	3	3
<i>Abeliophyllum</i> Main Nursery	2	3	1	2	1	2	3
<i>Abeliophyllum</i> SPU	4	4	3	3	3	3	2

*Abeliophyllum distichum* rooted best in the Fertil plug and in the Humax and less well in the Ellepots and peat/bark/perlite mix when grown in the main nursery unit. They rooted well in the Fertil plug and Geo pot and less well in the Humax, in the SPU.

*Rosmarinus* 'Tuscan Blue' rooted well in the Fertil plugs and least well in the Humax and Geo pot in the main nursery unit. There was little difference between the media in the SPU.

With both *F. magellanica* var. *molinae* 'Sharpitor' and *C. × clandonensis* 'Persshore Jubilee', there was very little difference in rooting in the different media or the two different propagation units.

With the exception of *C. × clandonensis* 'Persshore Jubilee', cuttings rooted better in the SPU than in the main nursery unit by one point on the rooting score. The environment in the SPU mist unit could be better for a number of reasons, including the size of the unit and the difference between rooting under glass and plastic.

The peat-free medium trialled was neither exceptionally better nor worse for rooting than any of the other media trialled and so has a place in propagation. Trials comparing propagation performance of different kinds of peat-free media would be useful while a larger trial using a greater number of replicates would enable more robust statistical analysis to be carried out, perhaps resulting in a more definite outcome regarding the optimum medium for each crop.

With the exception of Humax, which performed consistently poorly in this trial, there was little difference in the rooting media generally. Other factors may therefore be more important in influencing commercial media choice, for example efficiency of handling and use, reliability of supply, and cost.

## **Integrated Pest Management for Ornamental Protected Plants<sup>©</sup>**

**Neil Helyer**

Fargro Ltd. Littlehampton, West Sussex BN17 6PP U.K.

**Integrated pest management (IPM) brings together all aspects of pest and disease control, cultural techniques such as general hygiene, ground cover materials for weed control, monitoring with sticky traps, and tracking plant movement being the first line of defense. Biological control should be the next strategy, introducing beneficial organisms as a preventive measure or at the first sign of a pest outbreak. Environmental preventative management of the growing area may help by inhibiting plant pathogens and by providing more suitable conditions for biological control agents to work more effectively. Pesticide use, preferably with selective products, should be used only when necessary; it is best to use a pesticide when pest numbers can be clearly seen on a plant or when leaf damage is evident. Biological control works best when pest numbers and leaf marking are low as a fully fed predator will take some time to digest its food before it starts eating again. This paper will describe the IPM practices currently used for several insects and mite pests on many nurseries in the U.K.**

### **INTRODUCTION**

All crops suffer pest outbreaks at some time or other. Numerous beneficial organisms can be used to control common pests such as aphids. There are also several pesticides with activity against aphids, for example, some of which can be integrated while others have a much broader range of activity, killing most natural enemies as well as the pest. Integrated pest management (IPM) is a more sustainable method of pest control using cultural techniques, biological control agents, and selective or short persistence pesticides to provide long-term pest management.

Pest identification and knowledge of basic biology is therefore essential for growers who want to manage a fully effective IPM programme. Sap-sucking pests such as aphids, mealybug, soft scale insects, and whitefly can excrete vast quantities of sticky, sugar-rich honeydew that, in addition to direct plant damage, will further disfigure plants with associated growths of sooty moulds and loss of plant vigour. Spider mites are also extremely common and severely damaging pests with a rapid rate of reproduction when conditions are hot and dry; predatory mites are available and frequently eradicate the pest completely. Various species of thrips can cause leaf damage as well as transmitting plant viruses. Vine weevil continues to be a major problem on protected nursery stock production units; granular pesticides incorporated into the growing medium can provide long-term protection, but remedial treatments may be required for unprotected plants or existing infestations. Nematode vine-weevil parasites, particularly the species active at low temperatures, now provide excellent curative activity for use through much of the growing season when ground temperatures are above 5 °C.

## IMPORTANCE OF MONITORING AND RECORDING

Monitoring and recording pest outbreaks to build up a diary of trends and identify vulnerable locations helps to reduce the incidence of major pest problems by anticipating and responding to problems quickly. Nothing beats regular crop scouting (walking through a crop lifting pots and turning leaves) for finding and monitoring pest or disease levels. To aid crop scouting, yellow sticky traps hung vertically are useful for catching winged aphids, leafhopper, thrips, and whitefly. To trap adults of scatella, sciarid, and leaf hoppers the trap should be placed horizontally. Blue traps tend to catch more thrips but can also attract high numbers of predatory hoverflies (they are also useful to catch houseflies).

Pheromone lures are available for a wide range of adult moths; however, most of these lures use a sex attractant to catch male moths and are specific to each species so correct identification is critical. A recent development is the use of an aggregation pheromone lure for western flower thrips. These lures attract both male and female adults to a blue sticky trap and are a significant improvement over nonlured traps. A programmed approach to pest control with regular introductions of beneficials for major pest organisms is best. However, where large infestations are found and a rapid response is essential to prevent further damage and spread of the pest; selective pesticides can be integrated to counter this attack without long-term effects on natural enemies.

## PESTS AND THEIR CONTROL

**Root-zone Pests.** The predatory mite *Hypoaspis miles* should be introduced into any plant propagation unit. It lives in soil, growing media, or capillary matting and feeds predominantly on sciarid larvae but will also eat thrip larvae and pupae, springtails, and other organisms in the soil. The mite is best introduced as a preventative treatment to all plants, ideally within 2 weeks of potting or striking cuttings, also at the very first sign of sciarid or scatella fly adults or larvae on the compost. Excellent results have been obtained by using *H. miles* at 100 to 150 mites per m<sup>2</sup> during propagation, as a single introduction on both seed- and cutting-grown material.

**Whiteflies.** Whiteflies should not be a significant pest in most propagation units. However, weaning units and subsequent growing-on areas are at risk from whitefly infestation that can be controlled biologically. The whitefly parasite *Encarsia formosa* is well known and widely used on many nurseries, particularly those producing fruiting salad crops. For ornamental plant production introduce *E. formosa* at 2 to 5 wasps per m<sup>2</sup> weekly for about 8 weeks to “seed” the area with parasites as a preventive measure. However, should a population of whitefly establish it might be necessary to spray with a contact insecticide such as Agri 50E (alginate and polysaccharides) or Stalwart (nico-soap). These are nonselective, but are of very short persistence and hence will integrate reasonably well. After reducing the pest population with a couple of sprays, *E. formosa* should be introduced at 5 to 10 per m<sup>2</sup> weekly for about 8 weeks.

In the U.K. there is now a SOLA (Specific Off-Label Approval) for the use of Chess™ (pymetrozine) at up to 6 g in 10 L for control of adult whitefly and their eggs on tomatoes. Under the current Long Term Arrangements for Extension of Use it is permissible (at grower risk) to use this rate of Chess on protected, non-edible crops. The product should be applied as a high volume wet spray and repeated after 10 to 14

days for best results. Although Chess may be slow to provide a full kill of the target pest it is remarkably safe to most beneficials, including parasitoid wasps.

Several growers have used a tank mix of Chess and Nemolt™ (teflubenzuron) to control whitefly with good results. However, this is a non-approved tank mix and is done entirely at grower risk. Growers have also tank mixed Chess with Dynamec™ (abamectin) making a very useful clean-up treatment for use on most plants to control a wide range of pests including aphids, leaf hopper, leaf miner, spider mites, thrips, and whitefly while having only a 1 to 2 week persistence against beneficials. It should be stressed that the use of any tank mixes, unless specified on the product labels, is entirely at grower risk; to minimize any potential damage always test on a few plants before widespread use.

**Aphids.** This pest can be a potential pest problem through all stages of plant production. *Verticillium lecanii* (an insect fungal pathogen) is ideally suited for use in propagation units and will provide excellent control of several pest species. This fungus needs specific environmental conditions for its activity: temperature of 12 to 28 °C and relative humidity of 85% or more. This high humidity requirement need not be permanent; approximately 6 h per day or 42 h per week will suffice so fungal activity can persist after plants leave the propagation unit. Periods of still air around plants help raise the humidity at the leaf surface and can be used to provide the necessary conditions for further fungal infection of the pest.

The parasite *Aphidius* and predator *Aphidoletes* will easily control most aphid species; these should be introduced fortnightly at the first sign of aphids at a rate of 500 *Aphidius* per 1000 m<sup>2</sup> and 1000 *Aphidoletes* per 1000 m<sup>2</sup>. This rate should provide adequate aphid control for much of the growing season and can allow a breeding population of control agents to establish over the site. *Aphidius colemani* attack small, round-bodied aphids such as *Aphis gossypii* and *Myzus persicae*, which are usually the first aphids to be found in the spring. *Aphidius ervi* is larger and thus better suited to target the larger species of aphids such as *Aulacorthum* and *Macrosiphum* species; these can be green or pink in colour and usually occur from mid summer onwards.

To broaden the scope of aphid parasites, which can be fairly specific in the aphids they control, an exclusive mix of the parasite species: *Aphelinus abdominalis*, *A. colemani*, and *A. ervi* sold as ACE mix or CE mix (250 *A. colemani* + 250 *A. ervi*) has been developed. One unit of ACE mix or CE mix will treat up to 500 m<sup>2</sup> and should be introduced fortnightly through the period when aphids are likely to occur. Although they are able to establish, localized introductions may be required through the season depending on plant movement through and off site.

Lacewing larvae (*Chrysoperla carnea*) will devour most aphid species and can be used to control quite large infestations. They will feed on other soft-bodied organisms including leafhopper nymphs, mealybugs, scale insects, spider mites, thrips, and developing whiteflies. Several nurseries have introduced lacewing larvae to hedges close to their glasshouses and tunnels in May and again in June. This has helped reduce the numbers of pests in the local environment before they migrate into the production area and establish a breeding population on site. Lacewing larvae can be cannibalistic if food supplies run short, so they need to be distributed thinly, rather than many in one place.

The aphicides, Aphox™ (pirimicarb), and Chess will integrate well with most biological control agents and can be used as clean-up sprays for any difficult or large outbreaks.

**Spider Mites.** Spider mites can survive throughout the year in a moderately heated house and increase rapidly when hot weather persists. A new development in spider mite control or prevention is the predatory mite *Amblyseius andersoni*, a U.K. sourced and produced mite available in controlled-release system (CRS) sachets that hang on plants and release mature mites continuously over a 6 to 8 week period. *Amblyseius andersoni* may also provide control of fruit-tree spider mites, russet mites, and other small prey but do not perform well on spider mite webbing. However, they survive well in surrounding areas, often ambushing straying spider mites and limiting their spread. Due to their ability to survive on other food sources, they are ideal to use as a preventive measure on susceptible plants.

The more voracious predator *Phytoseiulus persimilis* can be used alongside *Amblyseius* species as a curative treatment. The licensed predatory mite *Amblyseius californicus* is tolerant to high temperatures and lower humidities; it can also feed on pollen, other mites, and small prey making it ideal to “seed” a susceptible crop before spider mites appear. *Phytoseiulus* continues to provide excellent curative control and will frequently eradicate a pest colony. The predator should be introduced at the first sign of spider mite damage, and a repeat application made a fortnight later. Further introductions may be necessary during the summer months.

Should spider mites not be noticed until plant damage is more evident, a rapid response is required to minimize further damage and pest spread. Spray with Dynamec followed 1 to 2 weeks later with an introduction of *Phytoseiulus* at 10 to 50 mites per m<sup>2</sup> of infested crop. Dynamec may be used for any early season outbreaks and as an emergency treatment in summer, up to 1 week before predator introduction. It also makes an excellent end of season clean-up treatment to prevent mites entering diapause. This pesticide is not photostable and will break down in bright sunlight conditions (May to August in GB&I) in about 5 to 7 days or less if continuously hot and bright. When the high rate is used (50 ml per 100 L), Dynamec has activity against leaf miners, thrips, other mites, and leaf nematodes. It can be harmful to biological agents for up to 2 weeks in the winter but less in summer or high light conditions. Torq™ (fenbutatin oxide) will integrate well with biologicals and should be used during spring and summer for any “hot spots” of mites along with *Phytoseiulus* or *A. californicus* to speed up mite control. Increased humidity around the plants helps to decrease spider mite reproduction and also improve predator activity. All predatory mites struggle to move between well-spaced leaves and plants. To improve their activity, strips of fleece can be draped over and between plants that improve mite mobility by acting as a bridge.

**Thrips.** The other major pest of protected ornamentals is thrips; usually western flower thrip and onion thrip although cereal thrips can cause widespread plant damage in late summer. The recently identified black “T” thrip *Echinothrips americanus* may be found on many houseplants and in interior landscaped atriums. Several thrips species are able to transmit plant viruses (tomato spotted wilt virus and impatiens necrotic spot virus in particular) to a wide range of plants potentially causing severe infection symptoms on the whole plant. Thrips also rasp the leaf surface causing distorted growth and loss of colour from flowers, followed by premature senescence.

Thrips are best tackled preventatively by introducing the predatory mite *Amblyseius cucumeris*, particularly to flowering plants. The mite can be introduced in

loose vermiculite carrier material weekly to keep thrips populations low. Alternatively use the CRS — a breeding population of predatory mites in a sachet. The CRS sachets last about 8 weeks and release mated females that distribute themselves over an area of about 1 m<sup>2</sup>. The CRS system is very good for use across a range of crops, in particular bench- or floor-grown crops where leaf contact between plants can be maintained. The waterproof sachets can also be hung on larger plants; they come in units of 40 or 200 and 500 CRS sachets.

Nemasys F<sup>TM</sup>, the foliar spray application formulation of the parasitic nematode *Steinernema feltiae*, has given excellent and reliable control of western flower thrips on chrysanthemum and other flowering plants such as gerbera and *Saintpaulia*. The nematodes should be applied weekly as a high-volume spray to leave a wet residue on the plant surface. Nematodes swim through this film of water to attack and kill various prey insects. Once the spray has dried, the nematode activity ceases so the application should be timed to allow a film of water to remain on the leaf for as many hours as possible. Some cut chrysanthemum growers are using the nematode only at certain stages of plant growth, i.e., Weeks 2 and 3 after planting and again at Weeks 7 to 12 or until harvest. Nemasys F comes in two unit sizes: one box of 5 × 50 million and one of 5 × 250 million. The suggested rate is 50 million in 40 L water per 400 m<sup>2</sup> as preventive treatment and 50 million in 20 L water 200 per m<sup>2</sup> as a curative for heavier infestations. The larger unit size of 250 million nematodes will treat up to 2,000 per m<sup>2</sup> per tray.

Should thrips become a problem Conserve<sup>TM</sup> (spinosad) will provide excellent control of all thrips stages and is safe to all predatory mites and nematodes; two sprays at a 5 to 7 day interval will usually correct an outbreak. Conserve has contact and translaminar activity and, from grower observations, will also provide incidental control of caterpillar, including tortrix moth larvae, although there is no label approval. When using Conserve, the whole crop should be treated so as not to allow any refuge for survivors. A maximum of six applications per structure per year is permitted as part of a resistance management strategy. Nemasys F can be tank mixed with several pesticides, a full and updated list is available from the supplier, Becker Underwood.

**Mealybug and Scale Insect.** These pests can establish on many plants, particularly woody ornamentals, slow-growing ornamentals, and even tomatoes. An unmated female mealybug can survive on an inert surface for 6 months or more before mating with a winged male and returning to a plant to reproduce. Biological control with the Australian ladybird *Cryptolaemus montrouzieri* works well on egg-laying species of mealybug such as *Planococcus citri* and some *Pseudococcus* species but these ladybirds can be slow to establish on long-tailed mealybug. *Cryptolaemus* also feeds on scale insects but will not establish without mealybug; also their larvae can be very noticeable on display plants, which has led to the preferred use of lacewing larvae for mealybug control.

Lacewing larvae are small predatory insects that will remain close to their release point, unlike *Cryptolaemus* adults that can easily fly away; a rate of 10 to 15 larvae per m<sup>2</sup> on a 2 to 4 weekly cycle is suggested, if needed. The parasitic nematode *S. feltiae* will control scale insects when sprayed on leaves; the nematodes swim through the film of water and enter under the scale to kill it. Specific parasites are seasonally available for mealybug and scale insect; contact Fargo for availability and advice.

Applaud™ (buprofezin), off label use at grower risk, will give good control of young mealybug and developing scale insects but has little effect on adults. White oils and soft soap sprays will also control mealybug, including adults if good contact can be made—watch out for phytotoxicity on some plants. Agri-50E™ applied as a contact spray will also suppress scale insects, particularly soft scale, and can be used on most plants with good results. Chess, a systemic insecticide with translaminar activity against most sucking insects, also has incidental activity against mealybug, psyllids, and scale insects while being safe to the majority of beneficials. Although these pesticides are approved on several crops, some uses are at grower risk, and it is still safer to test on a few plants first.

**Caterpillar.** Butterfly and moth larvae, in particular tortrix, can be controlled with routine sprays of the bacterial parasite *Bacillus thuringiensis* as DiPel DF™, which has given excellent results. The parasitic wasp *Trichogramma* will give reasonable parasitisation of eggs from most moth species; these are introduced on cards when moths are flying mid spring to later summer, depending on weather conditions. Pheromone traps are a very useful addition to the IPM programme and will attract tortrix moths from a wide radius, indicating when to begin a spray programme and often providing a degree of pest control.

**Vine Weevil.** These days vine weevil should not be a problem due to the use of compost incorporated insecticides. However, if larvae are found on any plants, the insect parasitic nematode *Steinernema kraussei* as Nemasys L can provide excellent curative activity. This species of nematode is active from 5 °C up to 25 °C and is applied as a drench to the compost. None of the currently used soil-incorporated pesticides have any effect on these nematodes except Temik™ (aldicarb).

## CONCLUSION

The key points to a successful, sustainable IPM programme is to use cultural techniques to start clean, keep the system clean, and finish the crop cycle clean. Biological control will keep a pest population low and can frequently eradicate pests completely. Selective pesticides can be integrated to control troublesome outbreaks.

Registered trademarks are acknowledged.



## Experiences in Propagation of *Cornus mas* and *Cornus florida* Cultivars®

**Norman Standbrook**

Midhurst, Ashley Road, Hordle, Lymington, Hampshire SO41 0GB U.K.

### INTRODUCTION

In my experience, the propagation of these species and their cultivars has always presented problems. However, perseverance and the investigation of a number of different methods have resulted in the following grafting and cuttings techniques that have proved successful.

***Cornus mas*.** There are many good forms of *C. mas* available. Cappiello and Shadow (2005) list more than 30, most of which are only obtainable from the U.S.A. I have only propagated *C. mas* 'Variegata' and *C. mas* 'Aurea Elegantissima', both of which proved to be quite difficult.

***Cornus florida*.** Cappiello and Shadow (2005) list 135 cultivars of this species; again, not many of them are available outside of the U.S.A., where the crop is reported to be worth \$50 million per year. In the U.S.A. budding is recommended as the most efficient propagation method. But this is probably not viable in the Great Britain and Ireland Region because of our more variable and unpredictable climate. *Cornus florida* has a reputation for being difficult to grow in the U.K. except on the south coast and in Cornwall. But it may be possible to grow it more widely if the climate here changes as predicted by global climate change forecasts. It would be good to see it become more popular in our market because it is a superb tree in all its forms.

### CUTTINGS

***Cornus mas* and *Cornus florida*.** I have successfully propagated forms of both species from semi-ripe nodal cuttings taken late June or early July when the material is firming at the base. The material should be reasonably strong and without any blemishes.

Cuttings were given a quick-dip into Synergol™ (50% IBA and 50% fungicide solution). They are then inserted in pots or plugs containing a rooting medium of 1 sharp sand : 1 fine peat (v/v) and placed on a mist bed with light shade and bottom heat at 15 to 18 °C. Rooting should take 5 to 6 weeks.

Rooted cuttings can be carefully potted on into a low nutrient medium and placed on a bed or bench with bottom heat (15 to 18 °C) and irrigated sparingly. We obtained best results with the use of supplementary sodium light to increase day-length, over a period of 21 days.

### GRAFTING

***Cornus mas*.** I have had moderate success with grafts performed in January and February onto pot-grown *C. mas* seedlings of pencil thickness or slightly less. These are normally available in the trade. Seedling stocks should be transferred into a warm growing environment at least 3 or 4 weeks before grafting, and grafting should only be undertaken when the stocks begin to show signs of growth. I have usually had most success using standard side grafts. The cambium layers are quite

thin in this species, which makes accurate carpentry and matching of the cambium layers in stock and scion important.

Stocks should be headed back to 30 cm in height and the scions should be no more than 18 to 22 cm. Tying material should be rubber, which expands as callusing develops and degrades in 2 to 3 months. After the carpentry the grafts are housed in a warm case or polythene frame at 15 to 18 °C. It is important to keep newly emerging foliage as dry as possible. When watering, avoid splashing water onto either the graft or new foliage, because this is associated with increased risk of fungal contamination. Shade should be provided to moderate temperatures on bright days.

Callusing normally begins within 2 weeks of grafting but is not very pronounced because the cambium layers are so thin. After 3 to 4 weeks the scions should begin to show signs of growth, at which time the stocks can be headed back again or snagged to just above the carpentry, taking great care not to damage the scion in any way. Also remove any stock shoots that may have developed below or around the graft.

After heading back replace the plants in the case or frame for a further week, then begin to wean by gradually increasing ventilation, replacing the cover with shade netting after 2 weeks. After a further 2 weeks the bottom heat may be turned off. Continue watering carefully until the plants are ready to pot on.

***Cornus florida*.** Generally these can be grafted in the same way as *C. mas* cultivars. However, *C. florida* understocks can be difficult to obtain.

One source of understocks is to raise *C. florida* from seed in preparation, this will need to be planned at least 18 months ahead of making the grafts. Fresh seed requires some 3 to 4 months stratification before sowing in the autumn; germination is then usually very good the following spring. When large enough the seedlings can be graded and the best potted ready for grafting the next January or February.

Alternatively, *C. kousa* may be substituted as an understock with good results.

As with *C. mas*, the wood of *C. florida* is dense and hard with a very thin cambium layer, so good carpentry is again essential. Also it is important to stick to the same degree of care for over-watering, shading, and weaning.

## CONCLUSION

On balance, the best and most reliable results are probably going to come from cuttings. However I understand that use of hot-pipe callusing on grafts during January and February has improved the success of grafting on a number of nurseries. It would appear there is more potential for research into the propagation of these plants. The old adage about paying attention to detail is particularly valid for the cultivars of these fine species.

## LITERATURE CITED

Cappiolo, P. and D. Shaddow. 2005. Dogwoods. Timber Press, Portland, Oregon.

## Experiences in Propagation and Production of Grasses and Grass-Like Plants<sup>©</sup>

Claire Wilson

C.J. Wilson Horticulture, Pitmore Lane, Lymington, Hants SO41 8LL U.K.

### INTRODUCTION

C.J. Wilson Horticulture runs a liner nursery with an annual production of 200,000 9-cm liners for the wholesale nursery market. Production is predominantly grasses (more than 150 taxa) but also includes clematis, ferns, and choice perennials.

When I decided to set up a nursery in 1997, I believed grasses were a good crop, which was unexploited at the time. Initially I saw them as part of the product portfolio and also planned to grow groundcover plants such as *Vinca* and *Hedera*, spot crops of patio plants, and clematis. However, the landscape market for groundcover plants contracted, the patio plants were hard to market in quantity, and clematis propagation coincided with the busy spring period. In contrast, the six taxa of grass I initially grew proved extremely popular, and I was soon sourcing new taxa from the U.S.A. that were already popular. I learned that whatever your initial plans you need to react quickly to your customers' requirements.

In my view, grasses are an ideal niche crop for a small specialist nursery. There is a wide range of species and cultivars, which are adapted to every climatic condition from arid Arizona to the mountain streams of New Zealand. There is lots of potential for the all important new introductions.

I use the term grasses in the loosest sense to define a group of plants with similar horticultural characteristics for the customer and include *Liriope* as well as rushes and sedges. Efficient production involves knowledge of the plant's native habitat, be it dry or wet, sunny or shady. Most importantly, grasses are divided into two groups according to their growth type.

**Cool Season Grasses.** Genera such as *Calamagrostis* and *Festuca* grow in temperatures from near freezing to 24 °C. They have two growth periods with an initial late winter to early summer growth phase interrupted by high summer temperatures and a decrease in rainfall. Growth resumes in the autumn and continues until the cold weather. In a nursery, growth can usually be maintained throughout the summer, given adequate water.

**Warm Season Grasses.** Grasses such as *Miscanthus* and *Pennisetum* typically break dormancy in spring and are very slow growing until summer arrives. They love sun and grow steadily until they flower in late summer.

### PROPAGATION

**Division.** Division can propagate nearly all grasses, and it is the only method for most cultivars. On the nursery we tend to undertake most division in the autumn and winter to smooth the labour profile. Cool season grasses split in the autumn will root up before the winter. Warm season grasses would ideally be split in the early spring just as they start into growth. However, for labour reasons, we tend to split in the winter. The plants make little root growth until the spring, so it is important to keep the growing medium dry. This is easier to achieve under glass than polythene but an open compost helps.

Division is my preferred method of propagating grasses. They can be split very finely into plugs, but I prefer to split them into larger clumps and pot back into 9-cm pots. This results in faster production and a bushier plant.

Division is labour intensive, and skilled staff is essential for efficiency. Division enables batching of plants to ensure there is always a crop of saleable plants.

**Seed.** Seed propagation is a potentially easy method for producing species crops. These plants are often available cheaply in the trade. I stick to the more difficult species such as *Stipa gigantea* and others that my customers demand, but I do not grow large numbers speculatively. Seedlings tend to be less bushy, and production takes longer; and production times can be erratic.

**Micropropagation.** A good method for obtaining a large number of the more popular cultivars such as *Miscanthus sinensis* 'Zebrinus', One advantage of this method, particularly with *Miscanthus*, is that the growth is very juvenile, resulting in many young shoots. These make ideal stock plants for later division. Because micropropagation is expensive it is only appropriate for high value, high volume taxa. Supplies can be erratic and crop failures can happen so care needs to be taken when choosing a supplier.

**Cuttings.** Some grasses will root from young shoots taken very close to the plant base. It can be a useful way of bulking up stock from a few plants. However, it can take a while to produce a saleable plant from this type of cutting.

## PRODUCTION

**Potting.** We pot all grasses by hand into 9-cm pots in shuttle trays. They are grown under glass on mobile benches with capillary matting. We use a fairly open growing medium — a mixture of 17 medium coarse peat : 3 pine bark (v/v). We incorporate a 12-month, controlled-release fertiliser (Sincrocell™, Sinclair Horticulture) at a low dose rate to maintain healthy growth.

**Pest and Disease Management.** Grasses are generally pest free. We use biological control in the glasshouse to manage sciarid, whitefly, and spider mites. Root aphid can occasionally be a problem, but can be easily treated with insecticides compatible with the biological controls. We also add fipronil (Vi-Nil, Certis) to the growing medium at mixing to control vine weevil. This pest is not generally a problem with grasses but we believe this preventative measure gives security for our customers.

Cereal rust can affect some ornamental grasses such as *Alopecurus* (oxtail grass), and powdery mildew can attack *Imperata* 'Red Baron'. Damping off caused by species of *Phytophthora* and *Pythium* can affect seedlings, so hygiene is essential and over watering should be avoided.

**Scheduling.** Grass liners need to be despatched at the right time to ensure they can be potted by the wholesale grower early enough to achieve maturity before their main selling season. It is therefore important to understand the lifecycle of each grass being produced and to know its best season of horticultural interest for the market.

I generally despatch cool season grasses in early spring. Warm season grasses are despatched when they have resumed growth in late spring. We have a blueprint for propagation, which works back from the wholesale customer's target delivery

date. A cool season grass needs to be ready for early spring, so we need to divide by early autumn.

## **MARKETING**

We work closely with our grower customers to ensure they are producing each taxon in time for their main season.

Warm season grasses are in flower late summer, but they tend to be very tall at this time. However, they will sell in flower better than any picture label. Retail producers need to be educated about the best time to pot grass liners, so the end product is at its peak in the optimum time frame.

Picture labels help to market the grasses when they are not in flower, but at present the range available is quite limited in comparison with the range of grasses being commercially produced.

There is also the question of whether grasses should be marketed as a separate plant group or whether they should be mixed in with other “looking good” crops throughout the year, for example as a type of plant that adds texture, colour, and flower to a display and so aids sales.

## **FUTURE**

There is a market view that grasses will go out of fashion. However, for diversity of colour, form, and flower they take some beating. And in Great Britain and Ireland, with impending climate change and possible hosepipe bans in drier regions, they offer good garden performance. Grasses fit well with modern gardens, being low maintenance and architecturally interesting throughout the year. It will be important for the trade to continue to select improved forms suitable for smaller gardens and patio planting.

## Propagation of *Cercis canadensis* 'Forest Pansy'<sup>®</sup>

Nicholas J. Murphy

Harley Nursery & Plant Centre, Harley, Shrewsbury, Shropshire SY5 6LP U.K.

***Cercis canadensis* 'Forest Pansy' is a deciduous shrub or tree cultivated for foliage and flowers. It is difficult to propagate vegetatively. Grafting and hardwood cutting trials were carried out in a glasshouse at Pershore College using a hot-pipe callusing system for the grafts and Malling bins for the hardwood cuttings. Four grafting techniques were used in four separate trials carried out over 3-week intervals. Two temperature treatments were used for the hardwood cutting trials. Apical wedge grafts at the earliest date resulted in the highest success rate. In the hardwood cutting trials no callus was produced and no roots were formed at either temperature, however the cooler treatment did yield more cuttings with vegetative growth than the warmer treatment.**

### INTRODUCTION

*Cercis* taxa are deciduous shrubs or trees that can be found in woodland, at woodland margins, and on rocky hillsides in the Mediterranean, Central and East Asia, and North America (Brickell, 1999; Raulston, 1990). *Cercis canadensis* 'Forest Pansy' is cultivated for its foliage and small, pink, pea-like flowers, which are borne profusely in spring (Brickell, 1999; Raulston, 1990). In today's hardy nursery-stock industry, small, compact-flowering trees are in high demand; the genus *Cercis* contains many desirable candidates that can meet this requirement because they can either be grown as a single or multi-stemmed tree in a container, as a specimen in a lawn, in a border in a commercial or residential landscape, or as a specimen tree in a residential street (Gilman and Watson, 1993; Raulston, 1990).

*Cercis canadensis* cultivars are difficult to propagate vegetatively so for my dissertation at Pershore College I was determined to find a successful method. The time my research could be carried out (October to mid-April) meant that softwood or semi-ripe cuttings could not be taken and that budding couldn't be used; this meant grafting and hardwood cuttings were the two propagation methods trialled. There was very little information on past trials on propagation of *C. canadensis* cultivars so I wrote to growers asking them what grafting technique they used; it was from their replies that I decided on four grafting techniques to trial. The aims of this experiment were to find a successful grafting technique for the propagation of *C. canadensis* 'Forest Pansy' and to examine whether hardwood cuttings were another viable method of propagation.

### MATERIALS AND METHODS

The experiments were conducted in a glasshouse at Pershore College. The stock plants used for the scion wood and hardwood cutting material came from a *C. canadensis* 'Forest Pansy' growing at Avonbank Nursery and from plants imported from Holland; the propagation material from the two sources was mixed to randomise its distribution. The rootstocks were bare-root *C. canadensis* seedlings graded at 4 to 6 mm diameter from Oakover Nurseries Ltd. in Kent. The grafting

techniques used were whip and tongue, saddle, apical wedge, and side-cleft; these techniques were carried out at 3-week intervals beginning on 14 Dec. 2004 and ending on 15 Feb. 2005.

**Grafts.** At each date, 160 grafts were made, i.e., 40 grafts from each grafting technique. Each grafting technique had a control and three replicates that consisted of 10 grafts in each. The finished grafts were dipped in low-melt-point wax then lined out for 14 days on a hot-pipe callusing system at a temperature of 23 °C. The roots of the grafts were covered with growing medium to prevent drying out. After 14 days the grafts were potted into 2-L pots and lined out on a glasshouse bench in a systematic block design. Observations on callus formation and vegetative growth were made at weekly intervals beginning when the grafts had been completed (Table 1 and Table 2). The Kruskal-Wallis test was used to test the results from the callus formation and stages of vegetative growth scores for statistical significance.

**Hardwood Cuttings.** Straight hardwood cuttings (20 cm long) were used in the trials. The cuttings were taken on 15 Jan. 2005. The trials were set up in two Malling hardwood-cutting bins run at 10 and 20 °C with 60 cuttings in each. The cuttings were dipped in Doff hormone rooting powder then lined out in a randomised block design in the bins at equal spacing with nine per row at a 45° angle in a 1 peat : 1 perlite (v/v) growing medium with the top two buds exposed. Observations on root formation and vegetative growth were made on 2 April 2005 (Table 2). The *z* test was used to test the results from the root and vegetative growth scores for statistical significance.

## RESULTS

**Grafting Trial.** The results from all four grafting trials were affected by two fungal outbreaks. Samples of the fungal spores were examined under a microscope: one remained unidentified, but the other was identified as coral spot (*Nectria cinnabarina*). Because the fungus affected later results for the first three grafting dates, the results for the statistical analysis were selected from the 8th week after each date.

**Callus Formation and Stages of Vegetative Growth.** The most successful grafting technique for callus formation and vegetative growth was the apical wedge graft; it resulted in the highest number of successful grafts from each grafting date. The side-cleft graft was the least successful with the percentage of failed grafts increasing with each successive grafting date while mean callus formation and vegetative growth score decreased with successive grafting date. The most successful grafting date for callus formation and vegetative growth was the earliest (14 Dec.); it resulted in the highest number of successful grafts of each type.

**Hardwood Cutting Root Formation.** Hardwood cuttings failed to produce any callus or show any sign of forming roots at either temperature.

**Stages of Vegetative Growth.** The majority of the hardwood cuttings failed to show any sign of producing vegetative growth at either temperature. However, the cooler treatment resulted in more cuttings with vegetative growth than the warmer treatment.



## DISCUSSION

**Grafting Trial.** The apical wedge graft at the earliest grafting date (14 Dec.) resulted in the highest number of successful grafts. *Cercis* has a very thin cambium layer, which makes matching the rootstock and scion difficult. The apical wedge graft exposes cambium on two sides so it increases cambial contact and the chance of the cambial layer being matched successfully. At the 14 Dec. grafting date the propagation material was fully dormant, so when they were lined out on the hot-pipe callusing system it was only the graft union that had its dormancy broken by the heat and was able to form callus. These grafts also had longer to continue to heal before phloem and xylem became "active" in the spring, whereas in the later trials the rootstock and scion might have to become "active" before the graft union had healed, flooding it and causing failure.

**Hardwood Cutting Trial.** For a cutting to be successful it needs to callus over the wound and develop roots. The type of hardwood cutting used could have affected callus and root formation. Instead of using the cuttings from the current season's growth, a heeled or mallet cutting that retained a piece of the previous year's wood at the base of the cutting could have been used because this serves as a larger store of carbohydrates, which could have improved rooting.

If a hardwood cutting fails to produce vegetative growth it will die because it can't replenish its store of carbohydrates, which it uses to survive the dormant season and produce roots. The cooler treatment cuttings produced more vegetative growth than the warmer treatment, in agreement with the findings of Dick (1982), who states a lower temperature for longer period of time is better than a warmer temperature for a shorter period of time. Whalley and Loach (1981) also state that the longer a hardwood cutting is kept in a heated bin the more its stores of carbohydrates will deplete and with it its chance of establishing itself. Perhaps if the cuttings had been kept at a low temperature then potted on after a shorter period they would have been more successful.

**Table 1.** Callus formation scoring system.

Callus formation scoring	Callus characteristic
0	A lightening in the colour of the scion material. When a knife edge is lightly scraped over the surface of the bark the cortex will be pale, not green.
1	There will be a mass of undifferentiated parenchyma cells, which are visible around 0% to 25% of the edge of the graft union.
2	There will be a mass of undifferentiated parenchyma cells which are visible around 26% to 50% of the edge of the graft union.
3	There will be a mass of undifferentiated parenchyma cells which are visible around 51% to 65% of the edge of the graft union.
4	There will be a mass of undifferentiated parenchyma cells, which are visible over 76% of the edge of the graft union.

**Table 2.** Stages of vegetative growth scoring system.

Stage of development	Bud characteristics
1. None	No expansion in length or diameter. Bud colour dull, like that of an overwintering bud. Bud tip acute.
2. Slight	Slight increase in length, but little or no increase in diameter. Bud colour brown-red. Bud tip acute.
3. Slight to medium	Acropetal one-fourth to one-half increased in length, but little increase in diameter. Colour similar to Stage Two. Bud tip acute.
4. Medium	Acropetal one-half to three-fourths increased in length, but only slight increase in diameter. Colour similar to Stages 1 and 3. Bud tip acute.
5. Medium to maximum	Bud increased in length over the entire bud surface and exhibited a marked increase in diameter. Colour similar to Stages 2, 3, and 4. Bud tip blunt (obtuse)
6. Maximum	Buds much increased in length and diameter over Stage 5 buds. Colour much lighter than in the previous stages due to extreme expansion of bud. Bud tip rounded.
7. Burst	Bud scales separated; leaf tips exposed; new stem not visible.
8. Expanded 1–7 inches	New stem visible and stem elongated 1 to 7 inches.

**LITERATURE CITED**

- Brickell, C.** 1999. Royal Horticultural Society new encyclopedia of plants and flowers. Dorling Kindersley, U.K.
- Dick, L.** 1982. An introduction to modern nursery stock production. Frederick Muller Limited, London.
- Gilman, E. F. and D. G. Watson.** 1993. *Cercis canadensis* eastern redbud. <<http://hort.ifas.ufl.edu/trees/CERCANA.pdf>> (online document accessed on 4 Oct. 2004).
- Raulston, J. C.** 1990. Redbud. Amer. Nurseryman, March 1 p. 39–51.
- Whalley, D. N. and K Loach.** 1981. Rooting of two genera of woody ornamentals from dormant, leafless (hardwood) cuttings and their subsequent establishment in containers. J. Hort. Sci. 56(2):131–138.

# Micropropagation of Mother Stock Plants at Walberton Nursery<sup>©</sup>

Claire K. Hobbs

Walberton Nursery, Yapton Lane, Walberton, Arundel, W. Sussex, BN18 0AS U.K.

## INTRODUCTION

Walberton Nursery is one of the founding members of the Farplants Group. The nursery was established in 1975 and is owned by David Tristram. Its main crops are herbaceous perennials including several that have been introduced or bred on the nursery including *Coreopsis grandiflora* 'Walcoreop', Flying Saucers™ blanket flower, *Crocsmia* 'Walcroy', Walberton Yellow™ montoretia, *Spiraea japonica* 'Walbumba', Magic Carpet™ Japanese spiraea, and *Erysimum* 'Fragrant Sunshine'.

The nursery has two small micropropagation laboratories on site. The first is used primarily for research and the production of virus-tested mother stock for in-house propagation and for other nurseries throughout the world. The second laboratory is currently used for the commercial production of two of our crops. In addition, there is a small isolation house where we are able to exclude the vast majority of pests and diseases and grow on plants from the laboratory ready for sale or use on the nursery.

## BACKGROUND AND HISTORICAL PERSPECTIVE

Plant micropropagation is the technique of growing plant cells, tissues, or organs isolated from a mother plant and grown on artificial media (George, 1993). It is a useful tool allowing the rapid production of clonal plants using relatively small amounts of space and supplies. It may be used by anyone from enthusiastic amateurs multiplying plants in the kitchen at home to distinguished scientists working in elaborate laboratories (Kyte and Kleyn, 1996).

It was in the 1830s that the seeds of micropropagation as we know it today were sown with the development of cell theory and the notion that tissue had the potential to differentiate into any type of cells. In the 19th century the presence of plant hormones was deduced and callus formation was observed in wounded trees. By the early 20th century attempts were being made to micropropagate monocotyledons while immature embryos had been isolated and fertile plants recovered from brassicas.

Through the next 50 years, significant developments took place, including work on the role of plant hormones in the development of micropropagated tissue, the embryo culture of a wide range of subjects, and the culturing of root explants. By the 1970s the principles of micropropagation were established and its commercial use was becoming feasible for a wider range of plant subjects. The number of nurseries involved in plant propagation through tissue culture grew rapidly during the 1970s and 1980s as techniques developed and became more widely utilised (Kyte and Kleyn, 1996).

Micropropagation was first used on a large scale by the orchid industry, enabling growers to overcome issues such as unpredictable seed, taxa that were difficult to propagate, and virus-infected plants (Kyte and Keyn, 1996). Micropropagation is now widely used throughout the world for the commercial production of a wide range of subjects including *Heuchera*, *Hosta*, *Digitalis*, *Fragaria*, *Geranium*, *Lavandula*, *Nemesia*, and *Yucca*.

## THE MICROPROPAGATION PROCESS

The basic procedure of micropropagation is relatively straightforward and consists of four main stages: explant establishment/initiation; multiplication; rooting; and acclimatisation/hardening off (Kyte and Kelyn, 1996).

A piece of tissue known as an explant is removed from the mother plant, carefully sterilised, and then placed in a test tube or similar sterile culturing environment. The explant may be a meristem, piece of stem, root, leaf, bud, seed, or flower part.

Once initiation has taken place, the explant is then able to grow and/or be divided to produce plantlets that can multiply almost indefinitely given proper care (Kyte and Kleyn, 1996). The plantlets are then rooted and acclimatised.

In its sterile environment the explant is given a balanced diet of nutrients and hormones often tailor-made to suit the particular species. The medium provides the major and minor nutrients and usually a carbohydrate (sucrose being the most common) to replace the carbon, which the plant normally fixes from the atmosphere by photosynthesis. Vitamins, amino acids, and plant growth regulators may be added to improve growth, and antibiotics may be added to control infections. A solidifying agent such as agar is used to thicken the medium and thus provide physical support to the explant (George, 1993). Although there are standard media mixes that may act as a starting point for micropropagation, the exact proportions of the ingredients can vary greatly between species.

Plant cells and tissues have the natural potential to put forth new growth and to multiply; micropropagation merely directs and assists this. New growth is usually initiated in meristematic tissue (undifferentiated cells that have not yet been programmed for their ultimate development). Such cells are located in the tips of stems and roots, leaf axils and margins, in stems as cambium, and in callus tissue. These cells are influenced by factors such as genetic make-up, light, temperature, nutrients, and hormones to differentiate into leaves, stems, roots, and other organs (Kyte and Kleyn, 1996).

## USE OF MICROPROPAGATION IN PRODUCTION OF STOCK PLANTS

**Advantages.** Micropropagation has a number of advantages over conventional propagation in the production of mother stock plants. Advantages include:

- Once a plant is in culture it is relatively easy to maintain and it is possible to sustain healthy material for many years.
- It is possible to achieve greater uniformity than with cutting-raised plants.
- Laboratory stock requires less space than conventional stock plants and a very small stock can be maintained which can be quickly multiplied. However, if micropropagation is being used as the source for mother stock plants, space will still be required for these plants.
- Micropropagation allows rapid multiplication from one plant, which is particularly useful if only one plant is available, for example, where a plant is particularly rare or a single plant from a breeding programme. The multiplication rates of different species vary greatly. Houseplants may take only a few days to initiate roots while some rhododendrons may take 4 to 6 months. If a plant in micropropagation were able to double in numbers every month

then a single plant could create 1024 plantlets after 10 months and 2048 after 11 months (Kyte and Kleyn, 1996).

- It is possible to produce plants “out of season,” and therefore year-round production of stock plants is possible. This can be particularly useful when exporting material to other parts of the world.
- Laboratory plantlets require less attention than stock plants on the nursery. Surveillance is necessary to check for signs of infection and progress and dividing and subculturing may be needed every 2 to 6 weeks, but the plantlets do not need watering, spraying, or weeding.
- Diseases, which can be transmitted through conventional propagation, may be eliminated through the procedures of micropropagation. External contaminants such as bacteria, fungi, and insects are removed when the explant is sterilised and using the apical meristem as the explant for the tissue culture may eliminate internal contaminants such as viruses. The apical meristem is a group of undifferentiated cells located at the microscopic tip of the dominant shoot. It is often virus free even in diseased plants because these meristematic cells haven't yet joined to the plant's vascular system and perhaps grow faster than a virus can spread. Thus if the few virus-free cells that make up the apical meristem are removed from the plant and placed in a culture they can grow and produce healthy, disease-free plants. This technique is known as meristem tip culture (Kyte and Kleyn, 1996).
- The ability to produce virus-free mother stock is a key advantage of micropropagation, particularly valuable in virus-prone plants such as *Nemesia*. Plant viruses may be observed by visible leaf symptoms; however, some latent viral symptoms may not be expressed in the plants when in culture and thus the virus testing of plants becomes essential. This may be done through the sap inoculation of an indicator plant with an extract from the infected plant tissue. Indicator plants such as *Chenopodium album* or *Nicotiana tabacum* show symptoms for a wide range of viruses (Cassells, 1992). Sap inoculation is an easy and inexpensive method of determining the presence of viruses although results may take a few weeks. If a virus is detected, other, more detailed tests such as electron microscopy or enzyme-linked immunosorbent assay (ELISA) can be carried out to determine the exact virus present. Elisa tests are available for the detection of over 100 different plant viruses (Gugerli, 1992). If a virus is detected meristem tip culture may be employed to obtain virus-free material.

**Disadvantages.** Micropropagation also inevitably has its disadvantages:

- It is labour intensive and requires highly skilled staff, especially at the research stage, in refining nutrients, detecting, identifying, and overcoming contaminants. Unless there is an established procedure for tissue culturing a desired plant the labour required to establish the right medium formulations and growing conditions can be time consuming and therefore costly. Labour may account

for up to 80% of the costs of running a laboratory (Kyte and Kleyn, 1996). Most large-scale micropropagation is now done in developing countries because of their lower costs of skilled labour. Many U.K. laboratories that existed in the 1970s and 1980s have now closed, and those that remain tend to be very specialised.

- Genetic instability can be an issue with micropropagated plants: thousands of plants could be raised only to reveal a defect when mature, which may be due to a chemical imbalance or a mutation that has multiplied in culture (Kyte and Kleyn, 1996). However, rooting and growing on a number of individual “test” plants prior to large-scale production could detect this. Some species are more prone to mutation than others. Some mutations may occasionally be desirable and result in new cultivars.
- Some plants appear impossible to micropropagate; on some cases the right method, media formulation, and conditions have yet to be found.
- Although micropropagation can be used to clean up plants prone to diseases and viruses, plants within micropropagation are prone to biological contaminants such as bacteria found on or within explants or in the laboratory. Infections can spread rapidly on agar and destroy the plantlets. Such risks are minimised by using sound sterile techniques in the laboratory. However, some plants, for example, some hellebores, carry endogenous bacteria, which are very hard to eliminate.

### SELECTION OF SUBJECTS SUITABLE FOR MICROPROPAGATION

A plant's growth characteristics in nature affect the ease with which it can be adapted to micropropagation, and as a rule, plants that show indeterminate growth are more successful in micropropagation than those that demonstrate determinate growth. Bulbs for example are difficult, especially as their growth underground means they are difficult to clean — meristems deep within bulbs make good explants but root explants are almost impossible (McCown and McCown, 1999). Unfortunately, assessing which plants will be suitable for micropropagation; how long they will take to establish a plant in culture and produce a rooted plant; and what the rate of multiplication will be can only be discovered with experimentation.

### CONCLUSION

Micropropagation has potential not only as a source for mother stock plants but as a propagation method in general. It can be a little strange to see plants growing in test tubes in sterile laboratory conditions with no soil in sight, but they are still plants and it is fascinating to watch them develop in their microenvironment and produce roots. At Walberton Nursery we have certainly benefited over the years from being able to “clean up” plants prone to bacterial infection and viruses. Our successes include our micropropagated *Daphne tangutica*, which is healthier and more vigorous than those propagated conventionally; we have removed the bacterial problem from our *Photinia* crop; improved the quality of our *Scabious*; and produce high quality plants as the base for our mother stock plants.

**LITERATURE CITED**

- Cassells, A.C. 1991. Problems in tissue culture contaminants, p. 31–44. In: P.C. Debergh and R.H. Zimmerman, Eds. *Micropropagation: Technology and application*. Kluwer Academic, Dordrecht, The Netherlands.
- Cassells, A.C. 1992. Screening for pathogens and contaminating microorganisms in micropropagation, pp. 179–192. In: J.M. Duncan and L. Torrance, Eds. *Techniques for the rapid detection of plant pathogens*. Blackwell Science, Inc., Oxford, U.K.
- George, E.F. 1993. *Plant propagation by tissue culture (Part 1)*, 2nd Ed. Exegetics Ltd, Wiltshire, U.K.
- Gugerli, P. 1992. Commercialisation of serological tests for plant viruses. In: J.M. Duncan and L. Torrance, Eds. *Techniques for the rapid detection of plant pathogens*. Blackwell Blackwell Science, Inc.
- Kyte, L. and J. Kleyn. 1996. *Plants from test tubes: An introduction to micropropagation*. 3rd ed. Timber Press, Portland, Oregon
- McCown, B.H., and D.D. McCown. 1999. A general approach for developing a commercial micropropagation system. *In vitro Cell. Develop. Biol.* 35:276–277.

---

**Use of Cost Analysis to Improve Nursery Profitability<sup>®</sup>****Will George**

Prenplants, Haven Road, The Haven, Billingshurst, West Sussex RH14 9BJ U.K.

**INTRODUCTION**

It is now possible to calculate the cost of every line of nursery stock on an individual nursery. The ease and accuracy of these costs will depend on the detail and quality of data collected by the nursery. In such a short paper it is not possible to fully cover all aspects of nursery stock costs. This paper will examine the most important factors that affect profitability and highlight the effects of time, space (crop density), yield, and waste on the profitability of nursery stock. The ways and means of allocating labour costs will also be reviewed.

**Current Performance Within the Industry.** Over the last few years the U.K. nursery stock industry has come under severe financial pressure. This has a number of causes. The market has slowed down due to adverse weather during key seasons and changes in consumer buying, resulting in over-production, both in the U.K. and in countries that export to the U.K. Many crops have been offered at low prices just to clear the backlog of plants.

At the same time, costs have been rising dramatically, and aggressive pricing policies from some of the larger multiple retailers are keeping prices of finished plants uneconomically low.

Tables 1 and 2 show the results from all nurseries within the Horticultural Trades Association's (HTA) Nursery Business Improvement Scheme (NBIS) for the 12 months to 31 March in each year. The NBIS is a scheme in which member nurseries can compare costs and other business data within local discussion groups. The data represent a comprehensive cross section of the industry and shows the trends within the nursery trade. Labour costs have increased dramatically over the last few years, as have transport, marketing, and sales costs, which are included in distribution. Despite a steady increase in productivity, the surplus available for extra income and investment has fallen.



**LITERATURE CITED**

- Cassells, A.C.** 1991. Problems in tissue culture contaminants, p. 31–44. In: P.C. Debergh and R.H. Zimmerman, Eds. *Micropropagation: Technology and application*. Kluwer Academic, Dordrecht, The Netherlands.
- Cassells, A.C.** 1992. Screening for pathogens and contaminating microorganisms in micropropagation, pp. 179–192. In: J.M. Duncan and L. Torrance, Eds. *Techniques for the rapid detection of plant pathogens*. Blackwell Science, Inc., Oxford, U.K.
- George, E.F.** 1993. *Plant propagation by tissue culture (Part 1)*, 2nd Ed. Exegetics Ltd, Wiltshire, U.K.
- Gugerli, P.** 1992. Commercialisation of serological tests for plant viruses. In: J.M. Duncan and L. Torrance, Eds. *Techniques for the rapid detection of plant pathogens*. Blackwell Blackwell Science, Inc.
- Kyte, L.** and **J. Kleyn.** 1996. *Plants from test tubes: An introduction to micropropagation*. 3rd ed. Timber Press, Portland, Oregon
- McCown, B.H.**, and **D.D. McCown.** 1999. A general approach for developing a commercial micropropagation system. *In vitro Cell. Develop. Biol.* 35:276–277.

---

**Use of Cost Analysis to Improve Nursery Profitability<sup>®</sup>****Will George**

Prenplants, Haven Road, The Haven, Billingshurst, West Sussex RH14 9BJ U.K.

**INTRODUCTION**

It is now possible to calculate the cost of every line of nursery stock on an individual nursery. The ease and accuracy of these costs will depend on the detail and quality of data collected by the nursery. In such a short paper it is not possible to fully cover all aspects of nursery stock costs. This paper will examine the most important factors that affect profitability and highlight the effects of time, space (crop density), yield, and waste on the profitability of nursery stock. The ways and means of allocating labour costs will also be reviewed.

**Current Performance Within the Industry.** Over the last few years the U.K. nursery stock industry has come under severe financial pressure. This has a number of causes. The market has slowed down due to adverse weather during key seasons and changes in consumer buying, resulting in over-production, both in the U.K. and in countries that export to the U.K. Many crops have been offered at low prices just to clear the backlog of plants.

At the same time, costs have been rising dramatically, and aggressive pricing policies from some of the larger multiple retailers are keeping prices of finished plants uneconomically low.

Tables 1 and 2 show the results from all nurseries within the Horticultural Trades Association's (HTA) Nursery Business Improvement Scheme (NBIS) for the 12 months to 31 March in each year. The NBIS is a scheme in which member nurseries can compare costs and other business data within local discussion groups. The data represent a comprehensive cross section of the industry and shows the trends within the nursery trade. Labour costs have increased dramatically over the last few years, as have transport, marketing, and sales costs, which are included in distribution. Despite a steady increase in productivity, the surplus available for extra income and investment has fallen.

**Table 1.** All nurseries analysis of costs in £ per m<sup>2</sup>.

	Return per m <sup>2</sup>	Labour	Distribution	Plants	Pots etc	Overheads	Surplus
2002	£12.26	£4.24	£1.12	£3.87	£0.83	£1.51	£0.68
2003	£14.94	£5.18	£1.40	£4.45	£1.45	£1.80	£0.65
2004	£20.23	£7.03	£1.83	£6.29	£1.83	£2.40	£0.85
2005	£19.41	£7.14	£1.95	£5.41	£1.48	£2.88	£0.55

**Table 2.** All nurseries analysis of costs as a percentage of output.

	Return per m <sup>2</sup>	Labour	Distribution	Plants	Pots etc	Overheads	Surplus
2002	£12.26	34.6	9.2	31.6	6.8	12.4	5.6
2003	£14.94	34.7	9.4	29.8	9.7	12.0	4.4
2004	£20.23	34.8	9.1	31.1	9.0	11.9	4.2
2005	£19.41	36.8	10.0	27.9	7.6	14.9	2.8

**Table 3.** Analysis of costs as a percentage of output for market sectors for the 12 months ending March 2005.

	Return per m <sup>2</sup>	Labour	Distribution	Plants	Pots etc	Overheads	Surplus
All sectors	£19.41	36.8	10.0	27.9	7.6	14.9	2.8
Amenity	£10.44	39.0	6.1	28.1	5.5	9.9	11.3
Retail	£25.81	35.4	14.5	29.0	7.5	19.9	-6.4
Liners	£68.72	32.3	7.1	27.6	8.2	11.4	13.3

As the profitability of the industry is falling it is now more important to establish the accurate cost of each line that a nursery produces. This is important in production planning and price setting.

Table 3 shows how various sectors of the industry are performing. Nurseries supplying the amenity market and young plants were doing relatively well up to the end of March 2005. Since then, even these sectors are beginning to find things more difficult. Nurseries supplying the retail market are finding trade particularly difficult because of a run of poor weather at critical periods, and other market forces.

### OBTAINING ACCURATE COSTS

Within each sector there will be a range of nursery performances with some being very profitable and others not so. It is quite amazing that, in a relatively small industry supplying similar outlets, the cost structures of individual nurseries differ so much. It is therefore important when attempting to find the unit costs on your nursery that you use your own data and not an average of other nurseries.

It is possible to calculate the cost of each line on nearly all nurseries from the data they commonly keep. The accuracy of the costs will depend on the accuracy of the data retained by the nursery. All the information required for finding the unit costs of each line should be available from the normal records and accounts kept by most nurseries. However it may be necessary to modify some of the records to give more accurate costs.

It is not necessary to include all the costs individually because some costs are so small when taken on a unit basis that they will make little difference to the overall cost structure. For example, if a nursery spends £504 on compost tea and produces 250,000 plants each year, the cost per plant is 0.2p per plant. However, several items such as this will amount to a more significant sum — it is easier to handle such items as a group rather than individual items.

On most nurseries costs tend to be historic and dynamic. To cost accurately it is usual to take historic data that will have been affected by circumstances within that time span, e.g., weather affecting sales, disease causing crop losses, etc. This should never be an excuse not to attempt a cost exercise because the results will be very informative and will help considerably in planning and price setting. However it should be noted that costs are controlled by many variables and as these change with time then so will the unit cost.

## TYPES OF COSTS

**Variable Costs or Direct Costs.** Variable costs are those that can be directly attributed to the crop such as pots, plants, labels, and so on. They can account for 35% to 40% of the total cost. They should be easy to allocate to a particular crop. Because most nurseries purchase their requisites from the same wholesalers, the price of most of these items is relatively constant.

In some costing exercises this is as far as the costing would go. The variable costs are taken from the output (sales) figure to give a margin. This gives an indication of the profitability of the crop but this is limited unless other factors such as time and space are taken into the calculation.

**Partial Variable Costs.** These are items usually included in fixed costs or overheads that can be calculated and applied to various crops. The best example would be transport, the cost of which can be easily calculated and added to the crop costs as a percentage or as a cost per unit.

In a similar way the cost of glasshouses or a heated propagation unit can be calculated either on a plant unit or an area basis, and this can be added onto the cost of plants that require these structures.

**Fixed Costs.** Fixed costs, or overheads, are those costs that cannot be directly related to a specific crop. Items include accountancy and other professional services, administration costs, insurance, and so on. Once labour and partial variable costs have been removed there should be relatively few true fixed costs to allocate.

Any allocation is going to be purely arbitrary, and it will be a matter of what best suits the nursery. Below are some of the methods used:

**Table 4.** Calculating labour costs from time sheet task analysis.

Task	Crop A (no.)	Crop B (no.)	Crop C (no.)	Total (h)	Total cost	Units	Unit costs
Seed sowing	100			1	10	100	0.10
Cuttings		100	100	3	30	200	0.15
1st pot	100	100	100	3	30	300	0.10
Trimming			100	2	20	100	0.20
Staking			100	2	20	100	0.20
Weeding	100	100	100	4	40	300	0.13
2nd Pot	100	100	100	4	40	300	0.13
Watering	100	100	100	3	30	300	0.10
Trimming			100	2	20	100	0.20
Dispatch	100	100	100	5	50	300	0.17

**Table 5.** Calculating unit labour per crop from task unit cost.

Task	Crop A (no.)	Crop B (no.)	Crop C (no.)
Seed sowing	0.10		
Cuttings		0.15	0.15
1st pot	0.10	0.10	0.10
Trimming			0.20
Staking			0.20
Weeding	0.13	0.13	0.13
2nd Pot	0.13	0.13	0.13
Watering	0.10	0.10	0.10
Trimming			0.20
Dispatch	0.17	0.17	0.17
Unit Cost	0.70	0.78	1.38

**Table 6.** Cost comparison between a similar plant produced in a 1-L and 2-L pot.

	1-L container	2-L container
Plug and label	34 pence	34 pence
Growing media	7	14
Pot and tray	5	7
Total cost	46	55
Price	123	191
Margin	77	136

## A. Plant numbers

$$\frac{\text{Total OC}^*}{\text{Total plant number}} = \text{Overhead/plant}$$

## B. Compost Volume

$$\frac{\text{Total OC}}{\text{Total volume compost}} = \text{Overhead/litre compost}$$

## C. Time and Space

$$\frac{[\text{Time (mo)} \times \text{area (m}^2\text{) Crop A}] \times \text{total OC}}{\text{Sum (time} \times \text{area) all crops}} = \text{OC/Crop A}$$

\*OC = Overhead costs

I prefer the time and space method because it reflects directly on the profitability of crops. It works best for a nursery that produces similar crops over a similar time scale but does not work as well for nurseries that produce very different crops over different time scales, such as a mixture of liners and open ground trees.

**Labour.** Labour is the largest single cost on most nurseries. It is also a cost that continues to rise. Nurseries, which have reduced their labour costs, are among the most profitable. Monitoring and accurately costing labour could well be the key to managing a successful and profitable business. It should be noted that not all of the labour cost is productive time. In nursery studies only 55%, on average, of the total labour budget is used on productive (crop-related) work. The remainder includes holidays, sickness, and non-crop-related work. It is important that this “down time” is included in any nursery cost exercise.

There are many ways of allocating labour costs. It will depend on the data available from the nursery how this can be tackled. The more sophisticated the nursery's recording systems the better the results should be. The results will also depend on the cropping systems of the nursery. It will be more difficult to allocate labour to specific crops when a nursery produces small numbers of many crops, than on a nursery that produces large numbers of a few crops. It would be possible to group crops according to similar labour needs.

Some nurseries treat labour as an overhead and allocate it in the same way as for other overheads, as explained above.

Another way is to record specific tasks on the time sheet and then allocate them to specific crops. Table 4 shows how task unit cost may be calculated once the total number of hours that each task takes. These costs can be used to calculate the unit labour cost for each crop (Table 5).

It is also possible to time the individual tasks that are involved in producing a plant, such as potting, trimming, etc. These sample times from the majority of tasks can be combined to produce a cost per crop or plant group. This method will not capture all of the labour cost but will help proportion the labour between crops. In previous exercises the best that sampling has achieved is 55% of the total labour cost. It is very important that these other labour costs are included in the calculation.

Some nurseries are starting to use data loggers to record labour data. This should give extremely accurate labour data per crop.

## FACTORS AFFECTING PROFITABILITY

**Time and Space.** Table 6 compares the cost of growing in two sizes of container. It would appear that the higher price commanded by the larger container gives a

**Table 7.** The effect of space on margin.

	1-L container	2-L container
Margin	77 pence	135 pence
Number of plants per m <sup>2</sup>	59	34
Margin per m <sup>2</sup>	4543 pence	4590 pence

**Table 8.** The effect of time on margin.

	1-L container	2-L container
Margin (pence)	77	135
No. of plants per m <sup>2</sup>	59	34
Margin per m <sup>2</sup> (pence)	4543	4590
Production time (months)	1.5	2
Margin per m <sup>2</sup> per month (pence)	3029	2295

**Table 9.** Value of waste from five nurseries.

	Value of waste (£)	Waste as % of turnover
2002	315,027	7.85
2003	383,081	8.81
2004	409,237	10.00

**Table 10.** Analysis of waste.

Not sold	90%
Watering	3.2
Disease	2.3
Poor grade	1.9
Pests	1.4
Weather	0.8
Poor culture	0.3
Weeds	0.04

**Table 11.** Cost comparisons of two liner crops.

	<i>Berberis thunbergii</i> 'Atropurpurea Nana'	<i>Spiraea × bumalda</i> 'Anthony Waterer'
Number potted	9354	3501
Cost	£1821	£633
Unit cost	£0.19	£0.18
Number sold	9254	1746
% Yield (%)	98.9	49.9
True unit cost	£0.20	£0.36

**Table 12.** The effect of reducing production:

	Initial production	Reduced production
No potted	3501	1770
Cost £	£633	£319
Unit cost £	£0.18	£0.18
Number sold	1746	1746
Yield (%)	49.9	98.6
True unit cost	£0.36	£0.18

greater margin and is therefore more profitable. However, if you look at the space each crop takes up it gives a slightly different picture (Table 7). In a given area, the number of 1-L pots that can be produced in a given area is greater than 2-L pots; thus the margin per given area will be greater

Table 8 shows how time affects profitability. A 2-L pot will take longer to reach a marketable size than a 1-L pot; thus in time and space terms the smaller pot is the most profitable.

In general the faster that a nursery can turn over its space then the more profitable it will become.

**Yield and Waste.** Waste on nurseries has been increasing over the last few years. While the average on individual nurseries is now about 10% (Table 9) there is a considerable range of between 4% to 24% waste. This figure is for finished plants and generally does not include propagation or young plant waste. If these plants were sold, that income would go straight onto the bottom line. Table 10 shows the analysis of waste from one nursery. The majority of waste is not from pests, diseases, or plant losses but from plants not being sold. Therefore, if the nursery's total waste was 10% of turnover, 9% would be due to lack of sales.

Table 11 shows the affect of yield (where %yield = 100 – %waste) on two liner crops. Initially the *Spiraea* looks the most economic crop because it is a penny cheaper to produce. However, only half the crop is sold so the true unit cost is much higher than originally estimated. It is important that, when calculating unit costs, the total cost is divided by the number sold not the number produced.

By reducing production, and therefore increasing yield by reducing waste, considerable savings can be made and profitability improved (Table 12).

## CONCLUSIONS

It is possible to calculate the cost of each line produced by a nursery. The methods used will depend on the quality of data produced by the nursery. It is important that the cost calculation is tailored to the specific nursery.

Once calculated, the costs will become historic but they still provide a very effective management tool in improving profitability.

The crop yield, the time the crop spends on a nursery and the space it takes up will also have an effect on profitability.



# Experience of Applying Lean Manufacturing on a Container Nursery<sup>®</sup>

**Gill Dowling**

Lowaters Nursery, Hook Lane, Warsash, Southampton SO31 9HH U.K.

## INTRODUCTION

Lean manufacturing is about improving efficiency and productivity and decreasing waste in the workplace. By following seven sequential improvement steps a business can save time and costs in all areas of activity.

In implementing lean manufacturing at Lowaters Nursery, our aim, as managers and supervisors, was to involve staff in tracking the time taken, movements involved, and cost of propagation by cuttings from the moment the secateurs were picked up by the person obtaining the propagation material to the moment the finished plant was put onto the lorry for despatch to the customer. We worked with the staff involved to identify where efficiency improvements could be made. We were amazed at the results.

## STEP 1: PROCESS MAPPING

A good visual way to start is by using a "string diagram" on a scale drawing. This will show you straight away the lack of order and considerable movement of people, tools, and materials involved in each task.

To do this process mapping you need a stopwatch, tape measure, and process activity chart. By observing a person carrying out a task we recorded and numbered all the process steps required to perform it, the time taken to do it in seconds, the distance travelled in metres, and whether it was adding value to the end product or not. Non-value-adding (NVA) tasks make up 95% of wasted time or costs on a typical nursery. This includes waiting time, delays, unnecessary movements, excess production, set-up time, breakdowns, searching for tools or materials, and storing. Value-adding (VA) tasks include those such as taking cutting material, sticking the prepared cutting, putting unrooted trays onto the prop-bed to grow, potting-up, trimming, adding picture/price labels, and loading onto the trolley ready for despatch.

## STEP 2: IDENTIFY VALUE-ADDING AND NON-VALUE-ADDING TASKS

On the activity chart we used different coloured sticky memo notepapers to signify VA tasks and NVA tasks, respectively. Each note detailed the step number, activity, time, and distance in red, black, blue, and green inks, respectively. We could then focus on reducing or eliminating the NVA activities and calculate how much money we could save.

From the records taken, the journey of one plant from cutting to end product took a grand total of 131 steps, of which only nine were VA. These VA tasks took a total of 30 sec. Non-value-adding steps took 8.8 h and involved the plant travelling a total distance of 3,038 m.

### STEP 3: IDENTIFY ALL POTENTIAL SOLUTIONS TO ELIMINATE NON-VALUE-ADDING TASKS

Brainstorming, then experimenting with different suggestions and evaluating them enabled us to speed certain processes up and has made many of the jobs easier and more efficient. In propagation alone, from taking the material out of the fridge to putting the stuck trays down in the fog involved 15 actions, only two of which were VA. To make one cutting either it or the workers involved travelled 210 m and took 285 sec. By streamlining the work area and working more efficiently we eliminated four NVA activities, reducing the distance travelled to 140 m, and the time taken to 170 sec.

### STEP 4: REJECT ANALYSIS

Another improvement process within lean manufacturing is reject analysis based on “the 5 whys.” For example:

- Why did we lose more than 2,000 of a batch of one particular taxon of *Hebe* to disease?
- 1,500 had *Botrytis*. Why?
- Environmental conditions. Why?
- Wet months. Why?
- Exaggerated by poor ventilation. Why?

Solutions included introduction of a preventative spray programme; improved instructions to the workforce on dumping dead material; regulating tunnel-side ventilation for frost, sunny, or rain conditions; giving the plants more space; and training staff on the correct way to water.

If you don't follow a line of questioning to its ultimate conclusion the problems will recur and continue to result in wasted time and money. Then you can make an educated decision whether to continue a process or drop it. If it is recognised that batches are still unsuccessful, don't continue with them in production.

### STEP 5: THE FIVE Ss

This is the starting point for continuous improvement and is based on a fundamental clear-out of the work place involving the whole production team.

**Sort.** All unwanted or unnecessary items are tagged and removed from the work-place. Any items in need of repair should be tagged for attentions. Infrequently used items should be stored away.

**Set.** Give everything a logical home and to a standard needed for an effective work-place. Everything has a place so keep it there. Frequently used items need to be within three steps of where they are used.

Once everything is in its place, the next step is to make visual signs and marked out locations for materials — for example shadow boards marking the location to which hand-tools should be returned for rapid access next time they are needed. At Lowwaters we have different coloured labels to show whether plants need to be trimmed, dumped, lifted for despatch, weeded, watered, etc. There are bed labels for sterilised beds and white-boards on which we can flag-up problems and day/week targets. Efficiency has increased as movement and searching for items has been improved.

**Shine.** This is, simply, keeping the area clean and leaving it as you found it.

**Standardise.** Implementation and training across the whole organisation.

**Stick.** Most importantly, stick to the five Ss.

### **STEP 6: PRODUCE AN IMPLEMENTATION PLAN**

New plans need to be prioritised. Have a person responsible for getting it done and a time scale. These should be reviewed weekly or monthly. Don't change things for change sake, you may find it won't make an improvement. Be aware that making changes at one stage may produce a knock-on effect down the line.

### **STEP 7: RUN TRIALS**

It is very important to involve all employees and brainstorm any ideas as a team to get the most suitable working layout. Continuous improvements means benefits achieved and lessons learned. The new patterns of behaviour will soon become the norm.

### **CONCLUSIONS**

For the lean manufacturing processes to work it is vital to track the action points each month to ensure continuity with your teams.

By focusing on NVA across the nursery and improving on our movements we were able to save a total of 534.5 h in a year, which amounts to £3,581.15.

If you do nothing then you will fall behind your competitors as they improve. Just remember, waste is costing your business not your customer.

The mapping process made us focus on our wastage or NVA so go in with an open mind — although you think your area may be efficient, think again!

# Propagation and Cultivation of *Arctostaphylos* in Relation to the Environment in its Natural Habitat in California, U.S.A.<sup>®</sup>

Lucy Hart<sup>1</sup>

School of Horticulture, Royal Botanic Gardens Kew, Richmond, Surrey TW9 3AB U.K.

## INTRODUCTION

The Mary Helliar Travel Scholarship helped to fund a visit to California to study native plants in their natural habitats and in cultivation. Throughout my study I observed *Arctostaphylos*, commonly known as manzanita, growing naturally and was able to relate the natural habitats to cultivation conditions in botanic gardens and commercial nurseries where I learnt about the propagation and production of members of the genus.

*Arctostaphylos* is a fundamental genus to California, found almost exclusively in the state, with different species occupying a range of habitats. It is a member of the Ericaceae and is closely related to *Arbutus*, sharing the same subfamily, *Arbutoidae*. The generic name is derived from two Greek words — *arktos* meaning bear and *staphule*, a grape. The common name, manzanita (popularly used in California today) is Spanish for “little apple” from the appearance of its berry. There are approximately 60 species, of which several have many subspecies due to frequent hybridisations within the genus (Stuart and Sawyer, 2001). This can make identification difficult in areas where species ranges overlap. Schmidt (1973), a manzanita enthusiast, describes her excitement regarding the future possibilities for more horticultural forms from the natural hybridisations, as a “tantalising prospect.”

## KEY HORTICULTURAL FEATURES

The genus includes many forms of evergreen, woody shrubs ranging from low, prostrate, mat-forming types to a few which approach tree size. The majority grow to between 60 and 200 cm tall and have a rounded or vase-shaped habit. All are relatively slow to mature. The fruits, especially those of the larger species, resemble miniature apples and are attractive to birds, while California Indians made cider from them. The seeds have an extremely hard coat, and the Indians used to grind the seeds to make a manzanita bread.

*Arctostaphylos* is prized for its colourful mahogany-red or cinnamon bark that is smooth to the touch or peeling in some species. The twisted limbs in the taller species provide sculptural interest.

The attractive urn-shaped flowers range from white to various shades of pink. The simple, alternate leaves are of a pleasing grey or lime-green shade, with new buds often providing a delightful contrast, some being pale green, downy from fuzzy hairs, crimson, or bronze (Schmidt, 1973).

## NATURAL HABITATS

*Arctostaphylos* species are most frequently found growing in the arid belts of California, on dry slopes and hillsides, and usually in full sunlight (Horn, 1998).

---

<sup>1</sup>Recipient of IPPS GB&I Region Mary Helliar Travel Scholarship, 2005

A typical habitat I observed while on a wildflower and botany course organised by the Yosemite Association is the Hetch Hetchy area of Yosemite National Park. The Hetch Hetchy dam trail is a foothill woodland habitat, 1300 m above sea level — hot and dry in summer with very little snow in winter. Many *Arctostaphylos* species including *A. viscida* subsp. *mariposa* were seen throughout the trail. While exploring the Merced giant redwood grove, *A. manzanita* was observed where there were gaps in the forest that let in valuable sunlight.

I was fortunate to join an expedition with Andrew Wyatt, head of propagation at Santa Barbara Botanic Gardens (SBBG) to collect seed and cuttings. We collected in chaparral vegetation around the Santa Ynez foothills of Santa Barbara, through Figuero Loop and Ojai Highway 33. Chaparral — tough woody, evergreen shrubs with dense foliage — is the most widespread form of vegetation in the Mediterranean part of California, covering about 5% of the state (Dallman, 1998). *Arctostaphylos glandulosa* is common to the chaparral community (Ornduff et al., 2003). Other typical chaparral species were also encountered including *Yucca whipplei*, *Adenostoma fasciculatum*, *Fremontodendron californicum*, and *Ceanothus* species.

**Drought Resistance.** Exposed to high sunlight levels in the summer, *Arctostaphylos* has many interesting mechanisms to avoid dehydration. Species will lose their leaves to prevent loss of water. Most species will hold their leaves perpendicular to the sun to avoid the direct glare. Leaves are also particularly waxy.

## VEGETATIVE PROPAGATION

During a 10-day internship at SBBG I worked alongside Andrew Wyatt who advised me on *Arctostaphylos* propagation techniques. For vegetative propagation, Wyatt (2005, pers. commun.) recommended using semi-mature cutting material taken from the previous season's growth, from December to January. Soft young growth is inclined to rot off more easily. The cuttings are treated with a standard IBA liquid hormone solution [concentration of 1 hormone : 15 water (v/v)] for 10 sec before inserting into 1 peat : 10 perlite (v/v) rooting mix. The cutting trays are then placed in a polythene enclosure in a shade house, under a solar-controlled misting unit with bottom heating mats. Wyatt has found lower growing cultivars such as 'Emerald Carpet' tend to root more easily and are more resistant to fungal pathogens. Some *Arctostaphylos* species have particularly downy leaves, which give rise to rotting and fungal problems.

Rooted cuttings are potted into liner pots containing a 1 sand : 7 peat : 7 perlite (by volume) potting mix. Established liners are then transferred to 1-gal pots containing a pre-mixed potting medium of 4-milled redwood bark chips : 1 washed and bleached sand (v/v), plus a base fertiliser ingredient, known only to the medium manufacturer. The medium has a dark blackish appearance mainly caused by the redwood bark tannins. The tannins have alleopathic properties that are leached out before being supplied as a growing medium ingredient. The medium has good pore space, holds moisture well, and has a springy texture that prevents compaction. Good aeration and drainage appears to be a key factor to the success of *Arctostaphylos* production. Weak concentrations of liquid foliar-feed fertilisers are applied to *Arctostaphylos*, as their leaves are susceptible to scorching, while growing on in 1-gal pots.

Tilden Botanic Garden, Berkeley, claims to have probably the most complete collection of California *Arctostaphylos* to be found anywhere (Friends of the Re-

gional Parks Botanic Garden, 2005). Its propagation techniques differ from those at SBBG. Steve Edwards, Tilden Botanic Gardens' director, said that cuttings of *Arctostaphylos* are taken during the summer months but grown in dry shade tunnels with no overhead misting or irrigation. He believes good ventilation, no bottom heat, and good drainage in pots with holes in the sides as well as the bottoms are imperative for success.

In Berkeley, I helped the California Native Plant Society (CNPS) East Bay Chapter with their native plant production for their autumn annual plant sale. Here cuttings are taken from November to February in order to produce 1-gal saleable plants for the following October. Mcpheeters (2005, pers. commun.) commented on the variable time for *Arctostaphylos* to root. Low-growing coastal species such as *A. uva-ursi* tend to root within 6 weeks with *A. uva-ursi* 'Woods' being one of the quickest to establish. Medium shrub and tree-like species such as *A. glandulosa* can take much longer, from 3 to 5 months to root.

### SEED PROPAGATION

Seed propagation of *Arctostaphylos* is more difficult than vegetative propagation. After seed collecting, food processors are used to extract the resilient fruit flesh from around the seeds. *Arctostaphylos* seeds have a tough, thick, seed coat and a scarification treatment is required to break the physical dormancy it imposes. Emery (1992) reported *Arctostaphylos* species can be given an acid treatment to break down the seed coat by soaking in dilute sulphuric acid for 2 to 4 h.

Fire scarification treatments are used at SBBG (Wyatt, 2005 pers. commun.). The technique involves setting fire to a 100 to 150 mm layer of pine needles placed over the seedbed with a few small pieces of wadded paper to help ignite the material. The flash fire treatment is a quick process, but effective high temperatures are reached. *Arctostaphylos* seeds then require a minimum of 2 months to germinate (Emery, 1992). If seeds are sown in October and no germination has taken place by June, the seedbeds are dried out for the summer and watering is resumed the following autumn, some germination may occur as late as the following spring (Emery, 1992).

### MANZANITA CULTIVATION IN GREAT BRITAIN AND IRELAND

The Californian climate offers its plants long, hot, dry periods, something that a summer in Great Britain and Ireland only occasionally does. *Arctostaphylos* are generally very drought tolerant. High rainfall within the Region of Great Britain and Ireland may therefore be the limiting factor to successful cultivation, rather than low temperatures. Most species are hardy to -12 °C or lower (Baldwin, 2005). There are, however, some durable cultivars grown in the Californian nursery industry, and utilizing drainage techniques such as growing in raised beds or in well-drained soils, moisture problems could possibly be overcome. At Tilden Botanic Gardens granitic and shale substrates are used in the planting area for higher elevation species (McPheeters, 2005, pers. commun.).

During my stay in Santa Barbara County I visited a few nurseries, including San Marcos Growers, who grow a good selection of *Arctostaphylos* cultivars. Baldwin (2005, pers. Commun.) recommends a reliable and garden worthy cultivar, *A. densiflora* 'Howard McMinn', which appears to grow happily almost anywhere. He has also found *A. Pacific Mist* to be dependable under adverse conditions (especially for a grey leaved manzanita). Bornstein (2005, pers. commun.) suggests *A. Canyon*

Sparkles', a SBBG introduction that might be suitable for the GB&I Region climate. Baldwin (2005, pers. commun.) also recommends 'Emerald Carpet', which grows quite well in California near the coast and requires summer irrigation in southern California. Baldwin (2005, pers. commun.) additionally suggests another of the cultivars San Marcos Growers produces, 'Sunset', describing it as an attractive garden-tolerant selection.

Provenance can play a big part in cultivation success, with species from northern California such as *A. canescens* usually being more tolerant of summer rainfall and lower temperatures (Wyatt, 2005, pers. commun.). *Arctostaphylos columbiana* has dark reddish-brown and white flowers and, according to Las Pilitas Nursery (2005), grows in clay soil as well as dry rocky slopes in the wild.

In southern parts of the U.K., perhaps the drought tolerance of manzanita species is a welcomed attribute rather than a limitation. It is well reported that climate change exists, and gardeners need to become proactive in reducing the usage of water. One obvious technique would be to grow species that require less irrigation.

### IMPROVING MANZANITA POPULARITY

Despite the ornamental attributes of these ericaceous, evergreen flowering shrubs there is still the potential to improve the popularity of *Arctostaphylos* within the Californian plant sale industry. Mcpheeters (2005, pers. commun.) comments that manzanitas are very popular at the CNPS plant sales with those who "enjoy the outdoors life" and who see *Arctostaphylos* growing in the wild on their walks and hikes. *Arctostaphylos* are an integral part of the California countryside. The walkers identify the plants with nature and are keen to capture that in their gardens. Those people who are not so familiar with the wild species do not identify their subtle beauty and tend to understand less about their specific cultivation needs.

With the stunning bark, urn-shaped flowers and interesting lime green to grey shades of evergreen leaves, it seems that *Arctostaphylos* has most of the ornamental features that garden centres require for their stock, except for being slow-growing and difficult to establish. *Arctostaphylos* is perhaps a plant for the dedicated only, but certainly one to experiment with.

### LITERATURE CITED

- Emery, D.** 1988. Seed propagation of native California plants. Santa Barbara Botanic Gardens, Santa Barbara, California.
- Dallman, P. R.** 1998. Plant life in the world's Mediterranean climates. Oxford University Press, Oxford.
- Horn, E. L.** 1998. Sierra Nevada wildflowers. Mountain Press, Missoula, Montana.
- Ornduff, R., P. M. Faber and T. Keeler-Wolf.** 2003. Introduction to California plant life (Revised Ed.). Univ. California, Berkeley, California.
- Schmidt, M.** 1973. Western manzanitas. *Amer. Hort.* 52(3):26–32.
- Stuart, J. D. and J. O. Sawyer.** 2001. Trees and shrubs of California. Univ. California Press, Berkeley and Los Angeles, California.

### ON-LINE SOURCES

- Las Pilitas Nursery.** 2005. <[http://www.laspilitas.com/groups/manzanita\\_arctostaphylos/Manzanita.html](http://www.laspilitas.com/groups/manzanita_arctostaphylos/Manzanita.html)> (Accessed 03/08/05).
- Friends of the Regional Parks Botanic Garden.** 2005. <<http://www.nativeplants.org/plants.html>> (Accessed 03/08/05).



---

**PERSONAL COMMUNICATIONS/ACKNOWLEDGEMENTS**

**Baldwin, R.** General Manager, San Marcos Growers, Santa Barbara, California, U.S.A.

**Bornstein, C.** Horticultural Director, Santa Barbara Botanic Gardens, California, U.S.A.

**Edwards, S.** Director, Tilden Botanic Gardens, Regional Parks, Berkeley, California, U.S.A.

**McPheeters, S.** California Native Plant Society East Bay Chapter, Berkeley, California, U.S.A.

**Wyatt, A.** Propagation Manager, Santa Barbara Botanic Gardens, California, U.S.A.

---

## One Nurseryman's Perspective on the Changing U.K. Nursery Trade®

### Peter Catt

Liss Forest Nursery Ltd, Petersfield Road, Greatham, Liss, Hampshire GU33 6HA U.K.

How you create a nursery business depends on individual circumstances: what one has to work with, how much money is available, how hard one is prepared to work, how tolerant or helpful one's partners are, how old one is, and what one's aims and ambitions are.

I had two starts with my own nursery. The first was in equal partnership with a financial partner. When that partner decided it was time to sell, we parted company and I bought a field and continued the business on my own. I had enough money to put up my first greenhouse and brought some polytunnels, stock, and equipment with me from the earlier business. I was prepared to work hard, and my wife was tolerant. I was 40 years old and at last had achieved my ambition of owning my own nursery.

However, owning the nursery was not enough in itself. I had started the first nursery with the aim of being a rhododendron specialist, grafting rhododendrons and propagating dwarf rhododendrons and azaleas from cuttings. I widened the crop range first to camellias then magnolias. My idea for the future of the nursery was taking shape, with the aim of offering a wide range of choice plants in small numbers to retailers. I recognised the risk of growing plants because I liked them, rather than because they would sell.

Each year I added to my plant list by making contact with people in New Zealand, Japan, the U.S.A., and Europe. I sourced plants that I believed would have potential in the U.K. market to add to my catalogue — I believed the future for my business lay in a range of taxa rather than in large numbers. This has continued, so that recently I have been grafting a number of exciting new *Hamamelis* cultivars such as 'Aphrodite', 'Harry', and 'Rubin'.

As there are already large numbers of cultivars of subjects such as clematis and rhododendron, I tend to concentrate on genera that have received less attention. I have for some years been sowing seed and selecting seedlings of *Lavatera*, *Choisya*, *Spiraea*, *Caryopteris*, and *Ceratostigma* and have introduced several selections to the market, such as *Lavatera* × *clementii* 'Burgundy Wine' and 'Candy Floss'; *Spiraea japonica* 'Candlelight', 'Firelight', and 'Whitegold'; *Caryopteris* × *cladonensis* 'First Choice', and *Ceratostigma willmottianum* 'Lice', Forest Blue™ Chinese plumbago.

I have also spotted sports such as *Choisya ternata* 'Lich', Sundance™ Mexican orange, though all I found was a very small leaf with an incomplete white edge. I rooted the piece and eventually forced a growth out of the leaf axil and out came a

## PERSONAL COMMUNICATIONS/ACKNOWLEDGEMENTS

**Baldwin, R.** General Manager, San Marcos Growers, Santa Barbara, California, U.S.A.

**Bornstein, C.** Horticultural Director, Santa Barbara Botanic Gardens, California, U.S.A.

**Edwards, S.** Director, Tilden Botanic Gardens, Regional Parks, Berkeley, California, U.S.A.

**McPheeters, S.** California Native Plant Society East Bay Chapter, Berkeley, California, U.S.A.

**Wyatt, A.** Propagation Manager, Santa Barbara Botanic Gardens, California, U.S.A.

---

## One Nurseryman's Perspective on the Changing U.K. Nursery Trade<sup>®</sup>

### Peter Catt

Liss Forest Nursery Ltd, Petersfield Road, Greatham, Liss, Hampshire GU33 6HA U.K.

How you create a nursery business depends on individual circumstances: what one has to work with, how much money is available, how hard one is prepared to work, how tolerant or helpful one's partners are, how old one is, and what one's aims and ambitions are.

I had two starts with my own nursery. The first was in equal partnership with a financial partner. When that partner decided it was time to sell, we parted company and I bought a field and continued the business on my own. I had enough money to put up my first greenhouse and brought some polytunnels, stock, and equipment with me from the earlier business. I was prepared to work hard, and my wife was tolerant. I was 40 years old and at last had achieved my ambition of owning my own nursery.

However, owning the nursery was not enough in itself. I had started the first nursery with the aim of being a rhododendron specialist, grafting rhododendrons and propagating dwarf rhododendrons and azaleas from cuttings. I widened the crop range first to camellias then magnolias. My idea for the future of the nursery was taking shape, with the aim of offering a wide range of choice plants in small numbers to retailers. I recognised the risk of growing plants because I liked them, rather than because they would sell.

Each year I added to my plant list by making contact with people in New Zealand, Japan, the U.S.A., and Europe. I sourced plants that I believed would have potential in the U.K. market to add to my catalogue — I believed the future for my business lay in a range of taxa rather than in large numbers. This has continued, so that recently I have been grafting a number of exciting new *Hamamelis* cultivars such as 'Aphrodite', 'Harry', and 'Rubin'.

As there are already large numbers of cultivars of subjects such as clematis and rhododendron, I tend to concentrate on genera that have received less attention. I have for some years been sowing seed and selecting seedlings of *Lavatera*, *Choisya*, *Spiraea*, *Caryopteris*, and *Ceratostigma* and have introduced several selections to the market, such as *Lavatera* × *clementii* 'Burgundy Wine' and 'Candy Floss'; *Spiraea japonica* 'Candlelight', 'Firelight', and 'Whitegold'; *Caryopteris* × *cladonensis* 'First Choice', and *Ceratostigma willmottianum* 'Lice', Forest Blue™ Chinese plumbago.

I have also spotted sports such as *Choisya ternata* 'Lich', Sundance™ Mexican orange, though all I found was a very small leaf with an incomplete white edge. I rooted the piece and eventually forced a growth out of the leaf axil and out came a

golden shoot. I have many new plants from various sources currently being evaluated and aim to continue to introduce new and exciting plants to the industry.

There is no point producing plants without having a target market. My own customer market has been developed over many years, and although I do not meet all of the nursery's customers myself now, I still like to talk to as many as I can because it is through these conversations that I hear what kinds of plants are wanted and can try to meet these demands. It is important for any nursery that wants to make a business of introducing new plants to bring potential customers to visit their trials and obtain the market's reaction to potential introductions.

If the climate changes as predicted as a result of global warming, then the industry may well need to grow different crops. In recent years the bedding plant industry has introduced many new species that have been taken up by the gardening public. This has also happened to a lesser extent in the herbaceous market but less so with trees and shrubs. The crop mix may also have to be modified in the light of future restrictions on, for example, the use of peat in growing media or the amount of irrigation water that can be used either on production nurseries or in our customers' gardens.

One thing that remains constant is that this industry is still an exciting one. Our products are bringing a great deal of pleasure to and improving the lives of a vast number of people.

## Modern Ways of In Vitro Propagation<sup>©</sup>

**Anne Kathrine Hvoslef-Eide**

Norwegian University of Life Sciences (UMB), Department of Plant and Environmental Sciences, P.O. Box 5003, 1432 Ås, Norway

### INTRODUCTION

Ever since Murashige and Skoog (1962) published their famous nutrient medium based on the analysis of tobacco ashes in 1962, there has been a steady increase of in vitro propagated plants throughout the world. In the beginning only a modest number of plants could be propagated. Today, only a few species are still considered to be recalcitrant, and we believe that all plants can be propagated by in vitro culture — in principle. There are still many challenges to overcome, especially since productive in vitro propagation (hence plant transformation) in many species is genotype-dependant. There are still some recalcitrant species as well, e.g., *Cyclamen persicum*. This species can be propagated in vitro from leaf discs and through somatic embryogenesis from ovules. However, both these methods are still a challenge with obstacles to be overcome to be efficient. Our experience with somatic embryogenesis is that embryogenic callus is easily induced from immature embryos as described in Winkelmann et al. (1998). Still, it is difficult to synchronise somatic embryo development and give a predictable number of germinating embryos (Hvoslef-Eide, 2000). Nevertheless, the total number of plants produced in vitro had a steady increase through the seventies and eighties in Europe, like the rest of the world. In the nineties European laboratories experienced harder competition from countries with cheaper labour and European production started to decline, despite the fact that total world production was still on the rise. It was necessary to be innovative in Europe and look for production methods that reduced the labour input.

### EXPLANATION OF TERMS IN USE

Propagation of plants is divided into generative (through seeds) and vegetative propagation. In this paper we will deal with vegetative propagation only. Traditional vegetative propagation includes cuttings, layering, or grafting. Cuttings can be without leaves (hardwood cuttings) or with leaves (softwood cuttings). A softwood cutting can be either just a leaf or a stem with leaves and with axillary buds in the leaf axils. Axillary buds are buds ready to burst given the right conditions, while adventitious buds break from a leaf with no preformed buds. This is an important distinction between adventitious buds and axillary buds. Only a few plants have the ability to form adventitious buds, e.g., *Begonia*, *Saintpaulia*, and *Streptocarpus*.

When propagating plants in vitro (= in glass), we use the same terms and call the shoots either adventitious if they break from leaf discs or axillary shoots if they originate from buds in the leaf axils or buds from a woody branch. By using in vitro culture, we can get adventitious shoots from many more species compared to traditional propagation, e.g., apples and other woody species. This is mainly due to the addition of plant growth regulators in vitro and the knowledge of how to manipulate cultures to form adventitious shoots. This ability to regenerate in vitro from leaf discs is an important prerequisite for most genetic transformation methods, especially using the soil bacterium *Agrobacterium*. Without a regeneration method

from leaf discs, where each shoot originates from one cell, it would be difficult to get solid transformants when using *Agrobacterium*. This method of transformation is the most common worldwide.

Chimeral plants have more than one genetic constitution in the same plant. Many plants are chimeric in nature. If the plant is chimeric with regards to flower colour, the chimeric nature is easy to spot by the different colours in the same plant or even same flower. An example could be the old cultivar of *B. ×hiemalis* 'Aida', which has a white rim around a salmon coloured flower. The colour of 'Aida' can be explained by the different cell layers in a plant. A plant has three to four (three is most common) cell layers (Preil and Engelhardt, 1982; Lineberger and Druckenbrod, 1985a; Preil, 1994b). The core of the plant is called LIII and can be compared to a hand, the next layer (LII) can be illustrated by a glove on the hand, while the last is the second glove over the first one. Hence a plant has two cell layers that cover the core (LIII) all around the plant. These two cell layers (LI and LII) have cell division periclinally, and this is why they cover the plant entirely in one cell layer each. In 'Aida' the outer cell layer (LI), and maybe even the next (LII), are without pigments and appear to be a white brim around each petal (Fig. 1). We can also often observe cultivars of *Saintpaulia* with dual-coloured flowers, so-called pinwheel flowering (Lineberger and Druckenbrod, 1985b). When propagating a plant, it is important to know if it is chimeral or solid. If it is solid all through the three (or four) cell layers, we can stimulate adventitious shoots and still get true-to-type plants back. Using adventitious shoots usually is more proliferative than stimulating only axillary buds to break into axillary shoots. If the plant is a chimera, we need to be very cautious; since adventitious shoots will arise from epidermis (LI) and the chimeral structure will be broken down. If this was a pinwheel-flowering *Saintpaulia*, almost all the flowers would be the colour of the epidermis and none of them would be pinwheel in the regenerated plants (Lineberger and Druckenbrod, 1985b). The only way to regenerate the pinwheel type is through axillary shoots from the buds in the axils in the flower peduncle, since axillary shoots keep the arrangement of the LI, LII, and LIII.

Growing callus (undifferentiated cells) on a solid medium or plant cells in liquid suspension cultures, somatic embryos may be induced. Somatic means that the cells originate from somatic cells. These are in contrast to gametic cells that will go through meiosis and the egg cell will fuse with a pollen cell to become a seed with a recombination of characters. The somatic embryo is a clone of the parent plant — "clonal seeds." These originate from single cells or small cell aggregates and differentiate into bipolar structures that resemble zygotic embryos (without the endosperm), truly demonstrating the totipotency of plant cells. Totipotency was first described by Haberlandt in 1902 and means that each and every plant cell has the totipotency to dedifferentiate (lose their function) and develop (differentiate) into a new plant with root and shoot (Gautheret, 1983). All the cells have the genetic information necessary to form a new plant, and plants have the ability to switch genes on and off through redifferentiation. This separates plants from animals that do not have the ability to turn genes on again if they have been differentiated and turned off in the process. One could say that the plant cells have the ability to make stem cells from differentiated cells.

Cell cultures can be an effective way of propagating plants. Cell cultures need minimal manual handling. But they require oxygen, or else they would drown. Cell



**Figure 1.** *Begonia*  $\times$  *hiemalis* 'Aida', showing one shoot with the original two-coloured flowers with the white brim and another shoot where the chimera structure has been lost and the flower is white through all three cell layers. Photo: Erling Strømme.

cultures can be grown in Erlenmeyer flasks on a rotary shaker to shake oxygen into the suspension. This gives the opportunity to grow many cells in a small volume. Such cells would have their origin from all cell layers (LI, LII, and LIII) and would mean the breakdown of a potential chimera. Mutations are quite frequent in plants; on average there is a mutation for every 1 million cell divisions (Broetjes and van Harten, 1978). It is therefore highly possible that every plant consists of some mutation or other, which in principle means that very few plants are not chimeral in nature. In my opinion, this could be the reason that we observe a higher frequency of variation (somaclonal variation) after cell and callus cultures than when plants are derived from adventitious shoots. Axillary shoots have even less variation, which also makes perfect sense. One needs to be aware of such potential for somaclonal variation when propagating plants. It is necessary to test methods and know the plant material well. Some species and some selections are more unstable in cell and tissue culture than others. Such plants can only be propagated in suspension cultures if a certain degree of somaclonal variation is accepted or wanted (as in the case of plant breeding).

Adventitious and axillary shoots can also be propagated in liquid cultures, in advanced bioreactors, or in simple temporary immersion flasks. The important thing is to secure enough oxygen or reduce the time immersed in liquid if oxygen is limited. Too little oxygen could result in vitrified (glassy) shoots. These have a physiological damage that cannot be restored, and they will not grow from shoots. In short, they are useless. Ziv (1989) has described this phenomenon in detail and suggests using plant growth regulators in the medium if all else fails.

## BIOREACTORS FOR LIQUID IN VITRO CULTURES

Bioreactors can be compared to the greenhouse compartments called phytotrons where the climate can be regulated in much more detail than a normal greenhouse. Bioreactors can control the environmental conditions for liquid suspension cultures to a very large extent, more so than Erlenmeyer flasks (Hvoslef-Eide et al., 2003). Depending on how advanced the bioreactor is, one can control temperature, oxygen, pH, light (quality, quantity, and day length), and the stirrer speed. The CO<sub>2</sub> content can also be controlled if one is willing to pay the costs of an electrode to monitor the concentration. There are many different bioreactors on the market, the simplest one hardly worth calling a bioreactor in my opinion. I would call them "bioreactors," since I think the term bioreactor should be reserved for the more advanced models where a true monitoring and control of parameters is possible. Since many include the simpler ones in the bioreactors category, they will also be included here. The simpler ones are useful for their purpose and deserve mentioning, even if the term bioreactor is somewhat misleading.

The different types of growth chambers for liquid cultures are:

- Temporary immersion
  - No stirring
- Simple "bioreactors"
  - Stirred by air through an inlet from the bottom (airlift)
- Advanced computer controlled bioreactors
  - Stirred by propellers
  - Stirred by Vibromix

Through European network cooperation, COST (COST is a non-commercial cooperation in the field of scientific and technical research, funded by the European Commission), a lot of knowledge on mass propagation through shoot and cell cultures have been acquired, e.g., propagation of poinsettia (*Euphorbia pulcherrima*) through somatic embryos (Preil and Engelhardt, 1982; Brandau et al., 1997; Osternack et al., 1999; Saare-Surminski et al., 2000), cyclamen (Hohe et al., 1999a; 1999b; Hvoslef-Eide and Munster, 1998), *Eustoma grandiflorum* (syn. *Lisianthus*), carnation (*Dianthus caryophyllus*), *Clematis*, *Anthurium*, *Phalaenopsis*, and *Gentiana* (Hvoslef-Eide et al., 2004), and shoot cultures of *B. × cheimanthus* (Christmas begonia) (Hvoslef-Eide, 2000). Geier et al. (1992) demonstrated that there is less variation after a suspension culture of *Euphorbia pulcherrima* (poinsettia), than in the callus culture of the same genotype that was the start culture of the suspension. This may possibly be explained by a selection towards embryos with all their genetic information intact; that cells without genetic changes have greater chance of producing a normal embryo.

**Temporary Immersion ('Ebb and Flo' System).** This system takes into consideration that most plants are not designed to be submerged in liquid, like aquatic plants are. The name temporary immersion speaks for itself; the plant tissue or plant cells are in one container and the medium in another container. With regular intervals, liquid nutrient medium is pumped into the vessel with the plants and the plants are submerged a very short while, for minutes only. Thereafter, the medium is pumped back into the reservoir vessel for the medium. This procedure is repeated a certain number of times through the 24-h cycle (Berthouly and Etienne, 2005). If this is repeated too often, the risk increases of obtaining vitrified shoots (shoots



damaged by hyperhydricity). At the same time, it is important to secure the plant's demands for enough moisture and nutrients. There is usually a fine balance, which is optimal. Saare-Surminski and colleagues (2000) have used temporary immersion for mass propagation of *Gentiana* over a propagation period of 12 weeks. By submerging the plants for 1 min 16 times per 24-h cycle, more shoots were damaged through hyperhydricity than when reducing the number of 1-min immersions to 8 (Hvoslef-Eide et al., 2004). Preil and his coworkers in Ahrensburg have designed homemade "ebb and flow" systems in 5-L glass containers. Using this system for as little as 1 min every 24 h gave excellent propagation of *Phalaenopsis* shoots (Hempling and Preil, 2005). This system secured good quality plants and a high proliferation rate at the same time as it reduced the input of manual labour substantially. In Sweden the Swedish University of Life Sciences has done experiments in similar containers using Preil's recommendations. They have very good results with only 1-min immersion per 24 h for raspberries, strawberries, rhubarb, and bilberries (Welander and Zhu, 2004). There are several commercial systems for temporary immersion on the market. They all have in common that the volumes of the containers are rather small, and hence the time saved for manual labour is less than when using Preil's large 5-L containers. Some of these commercial systems are also very expensive.

**Simple "Bioreactors."** The simplest bioreactors are just plastic bags with sterile filters and a bubble aeration from the bottom. The air serves two functions in such a system: one is to supply oxygen to the plants, the other to provide mixing of the cultures. Surplus air is let out through another sterile filter through the top. These are the cheapest types of bioreactors and are much used in Israel for a number of shoot cultures (Ziv et al., 1998; Ziv, 2005). Shoots cultures can withstand such conditions better than more shear-sensitive suspension cultures. The inconvenience with such a system is the burst of the air bubbles when they reach the surface, where the burst causes cell death and foam on the cell suspensions. Problems with hyperhydricity are often overcome by using different types of growth retardants in the medium (Ziv, 2005).

**Advanced Computer-Controlled Bioreactors.** The COST group has experimented with two different commercial bioreactors, both controlled by computers, of the same size (2 L): Braun Biostat and Aplikon. In both these commercial bioreactors, the COST members have most often modified the oxygen supply according to the recommendations by Walter Preil and coworkers (Luttman et al., 1994). The supply of oxygen is secured by diffusion through very thin silicone tubing (0.2 mm) in a 2-m long tube by various systems. The common feature of all these modified oxygen systems is that they were all fixed installations in the bioreactors. The thin walls of the silicone tubes allow diffusion of gasses (oxygen, CO<sub>2</sub>, and ethylene) to enter and escape according to the difference in concentrations of the medium and the tubes. This allows non-sterile air enriched with oxygen to be used, since the contaminants are too large to pass through the pores of the tubes. This is an efficient way of supplying oxygen and removing exhaust gasses as long as the tubes are not too old. We have reported earlier of problems with clogged up tubes (Hvoslef-Eide and Munster, 1998). The recommendation is thus to replace all the tubes at regular intervals to ensure good diffusion of gasses.

Several types of stirring mechanisms have been used by the COST members, both propellers and a type of mixer used for mixing paint called Vibromix. This a metal plate with conical perforations that vibrates at high speed. Although they were designed to mix paint, they are quite effective also for cell cultures. Some cultures that are especially sensitive to shear forces may respond negatively to the Vibromix, but these mixers are better than the normal stirrer provided in commercial bioreactors (Preil, 1988; 1991).

Using computers to control the temperature, oxygen level, stirrer speed, etc. is very accurate. The temperature is controlled through water baths with a water flow in a double jacket around the bioreactor. The oxygen level is controlled by an electrode measuring the oxygen saturation in the medium and a valve enriching the air of the silicone tubes with pure oxygen. If required, the pH can also be controlled through adding acid or base through sterile filters in the lids of the reactors (Hvoslef-Eide et al., 2005).

**Development of Novel Bioreactors for Mass Propagation of Plants.** At the Norwegian University of Life Sciences, UMB (formerly Norwegian University of Agriculture, NLH) we had a strong motive to establish methods of mass propagation, which required less manual input and less work in the flow hood and are more effective than the tissue culture methods on solid medium. Preil and his coworkers in Ahrenburg in Germany had already introduced the idea of using suspensions to produce somatic embryos in liquid cultures (Preil and Engelhardt, 1982; Preil et al., 1982). He also introduced the use of commercial, computer-controlled bioreactors for mass propagation in the COST cooperation (Preil, 1988; 1991). At first, poinsettia was introduced as a model plant but plants from somatic embryos of poinsettia turned out to be without the important branching factor. Today we know that this branching factor is a plant pathogen (a phytoplasm), which was removed through cell cultures. Without the branching factor, the plants were almost 2 meters tall with a single star at the top (Preil 1994a). At the Norwegian University of Life Sciences (UMB) we made use of Preil's expertise and came to visit him in his laboratory to study bioreactor design and the pros and cons of the commercial types he had there. Then we designed our own bioreactors. The disadvantages of the commercial types were many, since they have been designed to grow bacteria and not plants:

- Stirring by propellers gave high shear forces, causing stress and cell death
- Supply of oxygen yielded bubbles that burst on the surface, causing cell death and foam
- Growth of cells on stationary oxygen suppliers inside
- Lastly, but not least, they were very expensive to purchase

The workshop at UMB used these experiences to construct and build a series of six identical bioreactors, taking into account the special requirements of successful growth of plants in liquid cultures. Comparable, computer-controlled bioreactors were available commercially at the time (1992) for approx \$30,000, while ours cost approximately \$10,000 each. Detailed descriptions of how our UMB bioreactors are constructed can be found in Hvoslef-Eide et al. (2005). In short; our bioreactors have been constructed so that there are no quiet zones where cells can settle and grow on the instruments and still not be subjected to high shear forces. This is obtained through installing the thin silicone tubing (2 m long) in loosely hanging



**Figure 2.** One of the bioreactors constructed and built at the Norwegian University of Life Sciences showing the loosely hanging silicone tubing and the pitch-blade propeller inside the bioreactor. The double jacket container to provide temperature control is also visible. The reactor has just come out of the autoclave where it has been sterilised together with one litre liquid medium. It has been calibrated and is now ready for inoculation of cells.

loops under the lid in a way to provide an inlet and an outlet after the whole length has been dipped into the medium, and able to move with the movement inside (Fig. 2). The other special invention is the pitch-blade propeller that changes direction at regular intervals (10 sec has been a good timing). By changing direction, the stirring can be so much gentler than if the stirring is in one direction only. Also the change of direction secures movement and no quiet zones where cells can settle. Otherwise, our bioreactors have exactly the same functions that the commercial bioreactors have for control of temperature, oxygen, and pH. They are different also in the mixing of the gasses and how the temperature is kept at set point (see Hvoslef-Eide et al., 2005 for details). We now have six identical bioreactors that can be used in factorial experiments, which gives much more information regarding effects and interactions than just comparing a bioreactor with the growth in Erlenmeyer flasks. We have grown suspension cultures of *Daucus carota* (carrot), *Betula* (birch), *Cyclamen*, and *Picea abies* (Norway spruce), obtaining somatic embryos (in Norway spruce only after plating the cultures on solid medium for embryo formation) in these bioreactors. We have also grown shoot cultures of Christmas begonia (*B. × cheimanthus*) with success.

## CONCLUSIONS

It is extremely important to know the plant material to choose the right method for vegetative propagation to get true-to-type plants in the regenerated plants. If

the plants are chimeras, the only method that can be used is regeneration from axillary buds, a method that ensures all three cell layers to be intact in the regenerated plants (e.g., in pinwheel-flowering *Saintpaulia*). Regeneration in liquid cultures gives a high proliferation rate and can be used when propagating genetically stable plants. Simple and advanced bioreactors have been successfully used for mass propagation of plants for both adventitious shoots and somatic embryogenesis. Often a combination of proliferation in bioreactors and temporary immersion is the most effective and gives good quality plants and a sound economy in commercial production.

## LITERATURE CITED

- Berthouly, M., and H. Etienne.** 2005. Temporary immersion system: A new concept for use of liquid medium in mass propagation, p. 588. In: A. K. Hvoslef-Eide and W. Preil (Eds.), Liquid culture systems for in vitro plant propagation, Springer, Dordrecht, The Netherlands.
- Brandau, K., W. Preil, and R. Lieberei.** 1997. Differences in compounds released by embryogenic and non-embryogenic suspension cultures of *Euphorbia pulcherrima*. Biol. Plant. 39(1):113-124.
- Broetjes, C., and A. van Harten.** 1978. Application of mutation breeding in the improvement of vegetatively propagated crops. Elsevier Scientific Pub., Amsterdam, The Netherlands.
- Gautheret, R.J.** 1983. Plant-tissue culture — A history. Botanical Mag. Tokyo 96(1044):393-410.
- Geier, T., A. Beck, and W. Preil.** 1992. High uniformity of plants regenerated from cytotogenetically variable embryogenic suspension-cultures of poinsettia (*Euphorbia-pulcherrima*) Willd Ex Klotzsch. Plant Cell Rpt. 11(3):150-154.
- Hempling, T., and W. Preil.** 2005. Application of temporary immersion systems in mass propagation of *Phalaenopsis*. In: A.K. Hvoslef-Eide and W. Preil (Eds.), Liquid culture systems for in vitro plant propagation. Springer, Dordrecht, The Netherlands.
- Hohe, A., T. Winkelmann, and H.G. Schwenkel.** 1999a. CO<sub>2</sub> accumulation in bioreactor suspension cultures of *Cyclamen persicum* Mill. and its effect on cell growth and regeneration of somatic embryos. Plant Cell Rpt. 18(10):863-867.
- Hohe, A., T. Winkelmann, and H.G. Schwenkel.** 1999b. The effect of oxygen partial pressure in bioreactors on cell proliferation and subsequent differentiation of somatic embryos of *Cyclamen persicum*. Plant Cell Tissue Organ Cult. 59(1):39-45.
- Hvoslef-Eide, A.K.** 2000. Bioreactors for propagation of ornamentals. Advances in Floriculture Research, Rapportør / Norges landbrukshogskole. E. Stromme. Ås, Norway, Agricultural University of Norway: 132-144.
- Hvoslef-Eide, A.K., P.H. Heyerdahl, and O.A.S. Olsen.** 2003. Challenges in scaling-up and automation in micropropagation, Toronto, Canada, Acta Hort. 77-84.
- Hvoslef-Eide, A.K., A. Hohe, B. Ruffoni, K. Saare-Surminski, and W. Preil.** 2004. COST experiences on bioreactors. COST843, Working Group 2 Annual Meeting, Debrecen, Hungary.
- Hvoslef-Eide, A.K., and C. Munster.** 1998. Somatic embryogenesis of *Cyclamen persicum* Mill. in bioreactors, Brussels, Belgium, COST Rpt. 1998-04.
- Hvoslef-Eide, A.K., O.A.S. Olsen, R. Lyngved, C. Munster, and P.H. Heyerdahl.** 2005. Bioreactor design for propagation of somatic embryos. Plant Cell Tissue Organ Culture 81 (3):265-276.
- Murashige, T., and F. Skoog.** 1962. A revised medium for rapid growth and bioassays with tobacco cultures. Physiol. Plant. 15:473-497.
- Lineberger, R.D., and M. Druckenbrod.** 1985a. Chimeral nature of the pinwheel flowering African violets (*Saintpaulia*, Gesneriaceae). Amer. J. Bot. 72(8):1204-1212.
- Lineberger, R.D., and M. Druckenbrod.** 1985b. Micropropagation of chimeral African violets. Ohio Agricultural Res. Deve. Center Res. Circ. 284:25-28.

- Luttman, R., P. Florek, and W. Preil.** 1994. Silicone-tubing aerated bioreactors for somatic embryo production. *Plant Cell Tissue Organ Cult.* 39(2):157–170.
- Osternack, N., K. Saare-Surminski, and W. Preil.** 1999. Induction of somatic embryos, adventitious shoots and roots in hypocotyl tissue of *Euphorbia pulcherrima* Willd, ex klotzsch: Comparative studies on embryogenic and organogenic competence. *J. Appl. Bot. Angewandte Botanik* 73(5–6):197–201.
- Preil, W.** 1991. Application of bioreactors in plant propagation, p. 425–445. In: P. Debergh and R. Zimmerman (eds). *Micropropagation: Technology and application*. Kluwer Academic Publ., Dordrecht, The Netherlands.
- Preil, W.** 1994a. In vitro culture of poinsettia, p. 49–55. In: E. Strømme (ed). *The scientific basis of poinsettia production*. E. Strømme (Eds). Aas, Agricultural University of Norway Advisory Service.
- Preil, W.** 1994b. The study of chimerism, elimination of virus, and the induction of mutagenesis in poinsettia, p. 57–63. In: E. Strømme (ed). *The scientific basis of poinsettia production*. Aas, Agricultural University of Norway Advisory Service.
- Preil, W., and M. Engelhardt.** 1982. In vitro separation of chimeras by suspension cultures of *Euphorbia pulcherrima* Willd. *Gartenbauwissenschaft* 47(6):241–244.
- Preil, W., P. Florek, U. Wix, and A. Beck.** 1988. Towards mass propagation by use of bioreactors. *Acta Hort.* 226:99–106.
- Preil, W., R. Koenig, M. Engelhardt, and A. Meierdinkel.** 1982. Elimination of poinsettia mosaic-virus (poinmv) and poinsettia cryptic virus (poicv) from *Euphorbia pulcherrima* Willd by cell-suspension culture. *Phytopathologische Zeitschrift-J. Phytopathol.* 105(3–4):193–197.
- Saare-Surminski, K., W. Preil, J.P. Knox, and R. Lieberei.** 2000. Arabinogalactan proteins in embryogenic and non-embryogenic callus cultures of *Euphorbia pulcherrima*. *Physiol. Plant.* 108(2):180–187.
- Welander, M. and L.-H. Zhu.** 2004. Development and optimisation of the bioreactor technique for production of horticultural crops. *Advanced regeneration in vitro*, Debrecen, Hungary, Annual Meeting of COST843, WG2, 45–46.
- Winkelmann, T., A. Hohe, and H.G. Schwenkel.** 1998. Establishing embryogenic suspension cultures in *Cyclamen persicum* 'Purple Flamed'. *Adv. Hort. Sci.* 12:25–30.
- Ziv, M.** 1989. Enhanced shoot and cormlet proliferation in liquid cultured gladiolus buds by growth-retardants. *Plant Cell Tissue Organ Cult.* 17(2):101–110.
- Ziv, M.** 2005. Simple bioreactors for mass propagation of plants, p. 79–94. In: A.K. Hvoslef-Eide, W. Preil (eds), *Liquid culture systems for in vitro plant propagation*. Springer, Dordrecht, The Netherlands.
- Ziv, M., G. Ronen, and M. Raviv.** 1998. Proliferation of meristematic clusters in disposable presterilized plastic bioreactors for the large-scale micropropagation of plants. *In Vitro Cellular Dev. Biol.-Plant* 34(2):152–158.

## Somatic Embryogenesis in *Schlumbergera truncata*<sup>®</sup>

Ezz Al-Dein Al-Ramamneh, Sridevy Sriskandarajah, and Margrethe Serek

The Royal Veterinary and Agricultural University, Department of Agricultural Sciences, Plant and Soil Science Laboratory, Floriculture, 40 Thorvaldsensvej, 1871, Frederiksberg C, Copenhagen, Denmark

### INTRODUCTION

Cacti are dicotyledonous perennial plants with specialised features adapted for survival in arid and other climatic conditions. *Schlumbergera*, popularly known as "Christmas cactus" or "Thanksgiving cactus," is an epiphyte native to forests in Brazil. These cacti are grown as flowering potted plants (Boyle, 1997).

The conventional methods of propagation are often inadequate to meet the commercial demands for those cacti that exhibit low rates of seed production, germination, growth, or lateral branching. In vitro propagation is a potential alternative for production of these plants (Hubstenberger et al., 1992). While axillary and adventitious shoots in *Schlumbergera* and *Rhipsalidopsis* have been produced in vitro from phylloclade explants and callus cultures and from shoot tips, the frequency at which these shoots are produced is still low and unsatisfactory.

The greatest importance of somatic embryos is its practical application in large-scale vegetative propagation. Furthermore, in vitro somatic embryogenesis is an important prerequisite for the use of many biotechnological tools for genetic improvement (Santacruz-Ruvalcaba et al., 1998). Up to now no somatic embryogenesis has been reported in *Schlumbergera*. The objective of this study was to develop a protocol for somatic embryogenesis in *Schlumbergera*.

### MATERIALS AND METHODS

Mother plants of *S. truncata* 'Russian Dancer' were grown in a greenhouse with 16 h light at 25–28 °C. Phylloclade explants were surface sterilised and grown in a medium consisting of MS salts (Murashige and Skoog, 1962), Staba vitamins (Staba, 1969), 22.7 µM TDZ and 1.3 µM NAA, 3% w/v sucrose, and gelled with 3 g·L<sup>-1</sup> gelrite (regeneration medium) and incubated in light in a growth room (17-h photoperiod) at 25–28 °C.

Callus developed on explants was subcultured on fresh regeneration medium approximately every 2 months over a period of 9 to 12 months. Small callus pieces (approximately 100 mg) were transferred to liquid medium in Erlenmeyer flasks (100 ml). The medium was based on MS salts and vitamins supplemented with myo-inositol (0.1 g·L<sup>-1</sup>), 3% w/v sucrose, and kinetin at 0, 4.6 and 7.0 µM. The cultures were shaken at 120 rpm using a rotary shaker and incubated at 27–29 °C under a light intensity of 4 µmol·m<sup>-2</sup>·s<sup>-1</sup> with 12 h-photoperiod.

After 37 days, callus was filtered through sieves (200 µm) and placed on gauze (TZMO SA, Polen) on the surface of MS-based medium supplemented with either 2,4-D (0.45 µM), or IAA (0.57 µM), or without hormones. For germination of somatic embryos, they were transferred to 1/2 or 3/4 strength MS media.

## RESULTS

Indirect somatic embryogenesis was induced from phylloclade explants of *Schlumbergera truncata* 'Russian Dancer' plants. Subculture of callus grown in liquid medium supplemented with 7.0  $\mu\text{M}$  kinetin to solid medium with either 0.45  $\mu\text{M}$  2,4-D, or 0.57  $\mu\text{M}$  IAA, or without hormones resulted in the differentiation of somatic embryos. Somatic embryos began forming after 3 months on the medium containing 2,4-D and after 5 months on the medium without hormones or the one with IAA.

## DISCUSSION

The high potential of auxins, particularly 2,4-D alone or in combination with other plant growth regulators, in the induction of embryogenic potential is evident. According to this study, it is necessary to transfer embryogenic tissue to a medium lacking auxin or one containing low auxin concentration for somatic embryos to form. It is also possible due to the long exposure of cultures to TDZ-containing media that TDZ partially has a role in the induction of somatic embryogenesis in *Schlumbergera*.

## REFERENCES

- Boyle, T.H. 1997. Holiday and Easter cactus, p. 82–88. In: M.L. Gaston, S.A. Carver, C.A. Irwin, and R.A. Larson (eds.), Tips on growing specialty potted crops, Ohio Florists' Assn., Columbus.
- Hubstenberger, J.F., P.W. Clayton, and G.C. Phillips. 1992. Micropropagation of Cacti (*Cactaceae*), p. 49–68. In: Y.P.S. Bajaj (ed), Biotechnology in agriculture and forestry. High-tech and micropropagation IV, Vol. 20. Springer-Verlag, Berlin Heidelberg, Germany.
- Murashige, T., and F. Skoog. 1962. A revised medium for rapid growth and bioassays with tobacco tissue cultures. *Physiol. Plant* 15:473–497.
- Santacruz-Ruvalcaba, F., A. Gutiérrez-Mora, and B. Rodríguez-Garay. 1998. Somatic embryogenesis in some cactus and agave species. *JPACP* 3:15–26.
- Staba, J.E. 1969. Plant tissue culture as a technique for the phytochemist. *Recent Adv. Phytochem.* 2:80.



## ***Campanula* (Campanulaceae) in Nature and in Pots®**

**Gert Jensen, Rune Harboe Nielsen, and Arne Skytt Andersen**

PKM Nurseries, Odense N, DK 5270 and Royal Veterinary and Agricultural University, Copenhagen, DK 1871

The Genus *Campanula* L. comprises some 320 species mainly found in the Mediterranean region, the mountains of Central and Eastern Europe, and a few species scattered in other areas of the world. A few of these beautiful plants have been cultivated as garden and rockery plants for a long time. During the late 1980s some Danish growers adapted *C. carpatica* and *C. poscharskyana* among others to pot culture in a combination production schedule in and out of greenhouses. Some selection and breeding took place yielding better and more flowers; also the cultivation practices were improved to give better postproduction shelf life. These species still comprise a large part of the about 10 million *Campanula* plants produced in Denmark each year.

It has been the goal of our company to constantly improve and find new products; thus a program for collecting and breeding of new cultivars of *Campanula* has been established.

This program aims to utilize the enormous variation found in nature within as well as among the separate species. This variation is a result of natural selection due to differences in microclimate, soil, and other edaphic features of the growing place. And the differences within a species can result in visible as well as intrinsic features such as longevity of flowers, variations in growth potential, vegetative propagation potential, and demands for special treatment, e.g., for floral induction. The visible differences may be related to flower size, leaf arrangement, and characteristics. Sometimes there is such large variations that one wonders if the plants belong to the same species.

These variations seldom appear in collections in botanical gardens; therefore it is imperative for a serious breeder to get out in nature and observe and if possible collect seeds and plants from different locations to be included in the breeding program of a given species.

The breeding program has resulted in several new cultivars of *C. cochlearifolia*, *C. × haylodensis*, and *C. portenschlagiana*.

### **INTRODUCTION**

The many species of *Campanula* are found mainly in the Mediterranean region, Carpatia to Caucasus, the Alps, and Himalaya Mountains (Fig. 1). There are several species that are endemic to other mainly northern hemisphere locations. *Campanula* plants are often growing in remote and difficult-to-access locations, e.g., on steep mountain outcroppings or in deep gorges and ravines where even goats and other mountain herbivores cannot devour them. The soils are poor; cracks in the rock are preferred habitats for many species. Propagation is mainly by seed distribution.

The Latin name means "little bell," and many of the plants belonging to the genus have true bell shaped flowers while others have more flat corollas. The common names of these popular garden and rockery plants are various forms including the term "bell": bluebell, harebell, bellflower, carpathian bells, etc. Some species have



**Figure 1.** Major areas of endemic *Campanula* species.

been widely cultivated through centuries, and songs and poems often mention the bellflower. One species (*rapunculus*) is a vegetable of some renown in the Orient. Leaves are used as salad, and the roots are eaten as radishes.

Plants are usually perennial, rosette-forming herbs; some species are annual or biennial. Alternate leaves have different shapes, often obovate to cordate with rosette leaves larger and more cordate than stem leaves. Roots are often long taproots sometimes with fleshy starch rich parts. All parts of the plants contain milky white latex. Most species are hardy to very low temperatures especially when kept on the dry side.

Flowers are sympetalous (have even given name to the type of flower: “campanulate”), drooping or upright in racemes or singular. Color is blue to violet, but white forms are found in most species, seldom a yellow variant occurs. The flowers are five lobed and contain five stamens and a five- or three-parted stigma. Seeds are abundant, small, ovoid and enclosed in a three- or five-valved capsule that dehisces either basally or along the seams.

In cultivation, cutting propagation is common for the perennial species while seed propagation mainly is used for the annual and biennial species; however a large number of certain perennial species, e.g., *carpatica*, are propagated by seeds.

In the following a few of the wild species with potential for use as potted plants or as breeding material will be described (more details can be found in the general references: Bailey, 1935; Lewis and Lynch, 1998; and Crook, 1951). The latter section contains information on the domestication of some of these and the successful breeding and improving the plants mainly for pot culture.

## SELECTED WILD SPECIES WITH POTENTIALS FOR USE IN POT CULTURE AND BREEDING

### From the Alps.

*Campanula medium* Linn. English name: Canterbury bells, Scandinavian name: Marieklokke. Hardy biennial up to 1-m high with floral spikes (racemes). Large flowers (5–6 cm long) upright, true bell shape. Blue to violet; white forms exist. Used in perennial garden borders, can be sown in the late summer and planted in the garden for early flowering next spring. Double forms and an almost daffodil

form ("calycanthema" called cup-and-saucer) are available. Natural habitat: Calciferous, dry soils on mountainsides in Italy and Switzerland. Sun-loving.

*Campanula pyramidalis* Linn. English name: chimney bells, Scandinavian name: Pyramideklokke. Very tall biennial — up to 2 m when flowering. Pyramidal racemes with numerous light blue to white, star-shaped flowers. Especially compact cultivar has been used as a potted plant. Natural habitat: as the former, but mainly occurring in Austria and the Dalmatian region.

*Campanula zoysii* Wulf. Has no common names. Short-lived perennial, tiny tufted plant, 1–2 cm high. Rare, found in rock crevices at high elevations (2000 m and higher) in the Austrian Alps. The singular flowers are large for such a small plant, upright, cylindrical to drum-shaped bells with a clear azure blue colour.

*Campanula pulla* Linn. No common names. Perennial herb, 7–14 cm high with glabrous, dentate leaves. Upright small (2 cm) flowers in loose racemes covering the entire plant with their deep blue spray of color. Hybrids called *C. ×pulloides* of this species with *C. carpatica* var. *turbinata* have very striking violet flowers. Grows in Austria at high altitudes (1500 m and higher) on rocky slopes.

### From the Mediterranean Region.

*Campanula formanekiana* Degen & Dorfl. Scandinavian name: Græsk (Macedonsk) klokke English name: Greek bells. Monocarpic (semelparous) species first found in 1931. Tall main raceme (up to 75 cm) supported by spreading basal, prostrate, and lateral racemes. Growing on limestone rocks in northern Greece and Macedonia. It is monocarpic, sometimes taking several years to reach flowering size, but is easily raised from seed. The corolla is fully campanulate, like a small Canterbury bell. Seed propagation.

*Campanula rupicola* Boiss. & Spruner, no common names. Growing in cracks in limestone rocks on Mt. Parnassus in Greece. Monocarpic rosette plant, the thin prostrate or decumbent flower stems bear a few small, short-petioled leaves and a few (usually not more than three) flowers, which, however, are carried erect and are large for the size of the plant, sometimes as much as 5 cm long and 2 to 3 cm across. It is generally of a blue or violet-blue color.

*Campanula oreadum* Boiss. & Heldr. No common names. Closely related to *C. rupicola*, but smaller in all parts. Monocarpic as are many other species from this area. All leaves are without any dentations, which serve to distinguish the species from most others of the group. The thin hairy flower stems with only a few small leaves often carry as many as five flowers on fairly long peduncles. Flowers are generally of a rich violet-purple color.

*Campanula carpatha* Halacsy. Growing in limestone rocks on the Greek Island, Karpathos; biennial with violet-blue, upright flowers. Small, compact plant 10–15 cm.

### From Caucasus.

*Campanula kemularia* Fomin. Growing on cliffs in Transcaucasia at high altitudes (2000 m). A very hardy, almost creeping perennial. The general habit shows that the stems should be erect but they do not seem strong enough to bear the weight of the many flowers, with the result that the greater part of the inflorescence is hidden among the basal leaves. Wide bell shaped blue flowers.

*Campanula latifolia* Linn. A common, tall (1 to 1.5 m) perennial species growing in woodlands all over Europe. Large, doubly serrated, cordate leaves. Flowers

purple or dark blue, hairy, 6 cm long in loose racemes. Variety *macrantha* from Caucasus is smaller in all parts.

*Campanula saxifraga* M. Bieb. Danish name: Klippekløkke. Growing in the mountains of eastern Turkey. Many closely related species and subspecies are spread all over Caucasus. Small (<15 cm high) tufted perennial. Upright blue bell-shaped flowers. Small rosettes of basal spatulate leaves, rotund and slightly dentate at the tips, upright stems bearing open cups thrust towards the sun, usually deep blue with a pale or even a white "eye."

*Campanula betulifolia* (syn. *C. finitima*). The stems, which have a few small ovate and petiolate leaves, are more or less freely branched and carry a loose cluster of erect, fully bell-shaped flowers in groups of three or four. Light pink flowers, no blue variants found. Grows on cliffs, only found in one valley in eastern Turkey. Perennial.

### From Himalaya.

*Campanula cashmeriana* Royle. Growing on cliffs in Kashmir. Many subspecies and close relatives spread all over Himalaya Mountains. Small (<20 cm) perennial, tufted, prostrate plant with large singular flowers, blue inside the bell, dusty white on the outside, keeled, lanceolate leaves. The species is included in the larger section of the genus in which the style is trifold and dehiscence is basal. It forms a woody rootstock that penetrates deeply into rocky crevices and from this are emitted a number of stiff zig-zaggy but often trailing growths bearing a few sessile light green, oblong, slightly dentate leaves about an inch long, covered with grey hairs. These stems are freely branched and carry numerous fairly large bells generally of a pale blue, which are inclined to droop.

*Campanula argyrotricha* Wall. ex A. DC. Very much like *C. cashmeriana*, but smaller in all parts. The root gives rise to numerous procumbent, hairy, thread-like stems, dichotomously branched, furnished with nearly sessile leaves that are thin, broadly ovate, only very slightly dentate, silvery-green in color and softly hairy. The flowers, on long pedicels and usually solitary, are about one cm long and hairy outside. Other colors than blue occur. Perennial.

*Campanula* sp. New unnamed species, found in the Chinese part of Tibet. Very interesting color combination. The center of the flower is cream colored, while the lobes are deep blue. Creeping perennial.

### East Asia.

*Campanula chamissonis* Felt. Widespread from Siberia to Japan (and Alaska). As with most members of the genus, the color is rather variable, from deep purple to a rather mauve blue with paler margins. Though usually plants do not exceed 8 cm in height, they may reach as much as 15 cm. They are generally single flowered, but in the stronger growing forms may be somewhat branched and carry five or six blooms. Pale blue, some striped flower variants have been described. Perennial.

### North America.

*Campanula scabrella* Engelm. From California to Washington. Growing in dry rocks exposed to full sun. The lower leaves form a rather dense rosette. The stems may be anywhere up to 15 cm high and usually terminate in a single erect flower though they may bear as many as four. The ex-appendiculate calyx has linear-lanceolate segments equal to the calyx tube in length, while the narrowly campanulate violet-purple corolla. Perennial.

*Campanula scouleri* Hook. Occurs from British Columbia into Alaska. Growing in soft, stony soil in woodlands. Perennial plant (10–30 cm tall) with acute, lanceolate to linear, serrate leaves. Pale blue, outward angled, paniced flowers with exerted styles.

*Campanula lasiocarpa* Cham. Occurs from northern parts of the Rocky Mountains to Alaska (and also in Japan). It forms neat tufts of smooth ovoid or oblanceolate leaves with noticeably jagged edges tapering to a narrowly winged and ciliate petiole. From each tuft rises a stem some 15 to 18 cm high bearing a few sessile lanceolate leaves each with three or four distinct teeth on each side and terminating in a single, large bell-shaped flower, sub-erect and, in the type, blue.

The Japanese form is larger in all parts. Growing on sandy gravel slopes at high altitudes above 1200 m.

### Natural or Old Garden Hybrids.

*Campanula* 'Lynchmere' Hort. Cross of *C. elatines* Linn. and *C. rotundifolia* Linn. Made in 1948 in England — is one of the latest introductions, has foliage and growth similar to *C. elatines* in its hairy form, but shows the influence of the second parent in the shape and carriage of the flowers a wonderful, deep-blue-flowering perennial plant — but very slow growing.

*Campanula* 'Kent Belle'. Cross between a European, *C. latifolia* Linn., and a Korean species *C. punctata* Lamm. It produces a number of thin branching stems sometimes as much as 3 ft high terminating in loose clusters of long, narrow, deep-purple buds that develop into pale lavender hanging bells 3 or 4 inches long. Occurred spontaneously in the nursery garden of Elizabeth Strangman, Kent, U.K. A wonderful perennial garden plant — flowering throughout the summer.

*Campanula* × *haylodgensis* 'Warley White'. Cross between *C. cochlearifolia* Lamm. × *C. carpatica* Jacq. Spontaneous crossing found in an English garden in 1899. The sparse leaves are heart shaped like the parents', but are of a characteristic yellowish-green shade. The flowers are semi- or fully-double, open and almost flat — and pure white. Perennial.

*Campanula* × *wockeii* 'Puck'. Presumably a cross between *C. pulla* Linn. × *C. waldsteiniana* Roem. & Schult. Unknown origin, but is suspected to be a natural hybrid. Introduced by Alan Bloom. From underground runners, up to 10-cm-long stems emerge bearing lanceolate sessile leaves. It has dangling deep-blue bells on neatly tapered racemes. Perennial.

### HISTORY AND PROGRESS OF THE INTRODUCTION OF CAMPANULAS TO MASS POT CULTURE

In the 1950s the production of *C. isophylla* Moretti began in Norway. This is a non-hardy species originating in the Mediterranean region. Its common name is Star of Bethlehem due to the star-shaped corollas; there is a blue and a white form. Like most *Campanula* species it is a long-day plant (Heide, 1965). The growth habit is somewhat trailing, and *C. isophylla* is often used in hanging baskets. Early research on production environment for flowering and growth retardation has been summarized by Moe and Heide (1985). *Campanula isophylla* was introduced in Denmark in 1960 by the founder of the PKM Nurseries, Poul Madsen; production at that time was about 250,000 in Europe. Table 1 gives the following development of the *Campanula* crop in Europe.

**Table 1.** Production volume of all *Campanula* species and cultivars in Europe from 1960.

Year	Numbers
1960	250,000
1970	500,000
1980	2,000,000
1990	3,000,000
2000	11,000,000
2004	15,000,000

In 1968 production of *C. carpatica* var. *turbinata* 'Förster' began at PKM. Initially it was a seed propagated crop, but soon selections were done for better flower color and more flowers. Seed propagation is still used in some nurseries. The selections were propagated by cuttings from around 1972. *Campanula carpatica* is a fully hardy perennial with large, single, blue or white, upright flowers (Bailey, 1934). Flowering is induced by cold treatments (Zimmer, 1990), which usually is achieved by growing the potted plants outside on field beds throughout the summer and autumn until light frost. In Scandinavia forcing is then done in greenhouses from January until May (Dinesen, et al., 1997; Dinesen and Andersen, 1999).

*Campanula portenschlagiana* Roem. & Schult. Began to be produced as a field crop in 1978, it is a trailing plant, Scandinavian name Krybe klokke, creeping bell flower with smaller (4 cm) funnel-shaped (infundibuliform) flowers of various shades of blue, but white cultivars are also available. It is cold requiring for induction of flowers, which develop after long-day treatment.

*Campanula cochlearifolia* Lam 'Elizabeth Oliver' English name: Dwarf Bells, Scandinavian name: Dværg klokke. 'Elizabeth Oliver' appeared in a garden near



**Figure 2.** Cold treatment for flower induction: 5–7 °C for 3 or 5 weeks compared to no cold treatment.





1 week after treatment



2 weeks after treatment



3 weeks after treatment

**Figure 3.** Silver thiosulphate treatments to improve longevity of flowers on *Campanula tubulosa* 'Sfakion'.



Nottingham in 1972 and was introduced as a pot crop in 1991. This small campanula is ideal for production indoors in greenhouses almost all year round, preferably in small minipots (6 cm). Several named and patented cultivars have been introduced as a result of breeding and selection at the PKM nurseries. Cultivars with other colors than the powder blue of this hybrid have later on been a result of breeding and selection at PKM.

*Campanula ×haylodgensis*. Originated as a spontaneous cross in 1885 at Haylodge gardens in England. The blue cultivar *C. cochlearifolia* 'Blue Wonder' was introduced as a minipot crop by PKM in 1995, first as a combination crop with field growing before forcing. White- and single-flowered cultivars as well as cultivars with larger flowers and more upright habit have been bred: 'White Wonder', 'White Fairy', 'Great Blue Wonder', and 'Great White Wonder'.

*Campanula tubulosa* Lam is one of the latest additions to the assortment at PKM. Seedlings from botanic garden plants of this Greek species has been selected for good performance in the greenhouse, good color, keeping quality, and general shape of the plant. A superior selection has been vegetatively propagated and has recently been named 'Sfakion' in reference to its origin and introduced on the market.

As an example of the domestication procedures we describe a number of experiments with this species (cultivar) that form the basis of the production schedules and various treatments.

First it was necessary to establish the method for producing cuttings to keep the plants in a sufficient vegetative state short-day treatments of 11 to 8 h was tested (Fig. 2). Flower induction is temperature controlled. It is necessary to cool the plants for some time; Figure 3 shows the plants with or without some weeks of 5–7 °C in short day. Three weeks is sufficient. Keepability of the flowering plants is better if they are treated with silver thiosulphate at 0.2%. These and other experiments resulted in the production plan shown in Fig 4.

Colored photos of some of the species and cultivars in this paper are available on the internet: <[www.pkm.dk](http://www.pkm.dk)>.

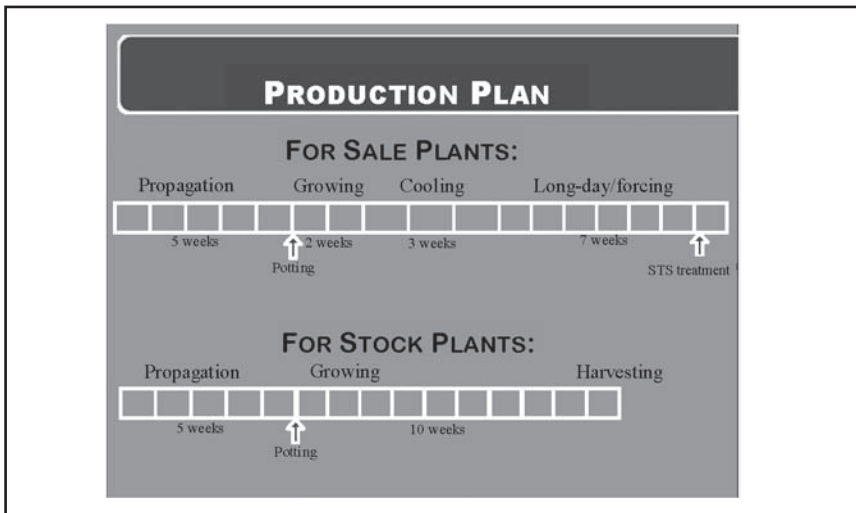


Figure 4. Production program for *Campanula tubulosa* 'Sfakion'.

**LITERATURE CITED**

- Bailey, L.H.** 1934. The standard cyclopedia of horticulture. Vol 1:642–650.
- Dinesen, L.G., A. Skytt Andersen, and Margrethe Serek.** 1997. Influence of late fertilization in the field on forcing of potted *Campanula carpatica*. *Scientia Hort.* 71:235–242.
- Dinesen, L.G., and A. Skytt Andersen.** 1999. Pot plant production of *Campanula carpatica* Jacq.: Low temperature treatment influences vegetative growth, flower induction and flower number in two cultivars. *Gartenbauwiss.* 64:266–271.
- Crook, H.C.** 1951. *Campanulas — Their cultivation and classification.* Country Life Limited, London, England.
- Heide, O.M.** 1965. *Campanula isophylla* som langdagsplante. *Gartneryrket* 55:210–212.
- Lewis, P., and M. Lynch.** 1998. *Campanulas — A gardener's guide.* B.T. Batsford Ltd., London.
- Moe, R., and O.M. Heide.** 1985. *Campanula isophylla.* In: A.H. Halevy (Ed.), *Handbook of flowering.* Vol 2 CRC Press, Taylor & Francis Group, LLC, Boca Raton, Florida.
- Zimmer, K.** 1990. Wann blühen *Campanula*-arten. Einflüss von Kühltemperatur und Tagesslänge. *Deutscher Gartenbau* 31:1985–1987.

## President's Welcoming Remarks®

### Tom Intven

Canadale Nurseries, Ltd., 269 Sunset Drive, St. Thomas, Ontario N5R 3C4 Canada

I'd like to welcome all attendees; in particular members from other regions—we have members from the Southern and the Western regions. We would also like to warmly welcome attendees from Chile, the Netherlands, and Belgium, and non-members and students. In particular we'd like to recognize and welcome new members. Would all new members please stand and be recognized. Ladies and Gentlemen can we please show our welcome with applause.

At this time I would like to recognize the Local Site Committee for all their hard work. Chair: Jim Johnson and Members Darrel Apps, Denny Blew, Joe Kiefer, Ted Kiefer, Andy Mackay, Ed Overdevest, Roger Ruske, and George Smith. I know how much work has gone into it. Please join me in congratulating and thanking the Local Site Committee for a job well done.

A special thanks to Steve Castorani for a terrific program; Steve, your efforts took the dual track program to a new level, not only offering simultaneous talks on woody plants and perennials but also, for the first time at an annual meeting, offering simultaneous Hispanic talks.

Thanks also to Darrel Apps for the poster session, great job Darrel.

I'd like to thank publicly our AV operators Dr. David Sanford and Scott Clark and their two Assistants from Rutgers Cooperative Extension: Jerry Frecon and Rich Obal. Your job is so valuable, and we thank you very much for making our meetings run so smoothly.

At this time I would like to have us recognize the passing of members since we last gathered: Sidney Waxman, University of Connecticut retired, member since 1962 (Honorary member, Award of Merit and Fellow Award) and Joseph Cesarini, Owner of Phyto Ecology, Ridgely, Maryland, a member since 1964.

## Exciting Developments in the World of *Cornus*®

**Elwin R. Orton and Thomas J. Molnar**

Department of Plant Biology and Pathology, Rutgers University, Cook College/NJAES, Foran Hall, 59 Dudley Road, New Brunswick, New Jersey 08901 U.S.A.

An attractive harbinger of spring, our native eastern flowering dogwood, *Cornus florida*, is one of the most highly prized species of small flowering trees. However, in many areas where it is grown, the plants fail to prosper due to their high susceptibility to the ravages of the common dogwood borer, *Synanthedon scitula*. Plants of *C. kousa*, native to China, Japan, and Korea, are highly resistant to this insect pest but became popular rather slowly in the United States as the period of floral display is about 1 month later than that of plants of *C. florida*.

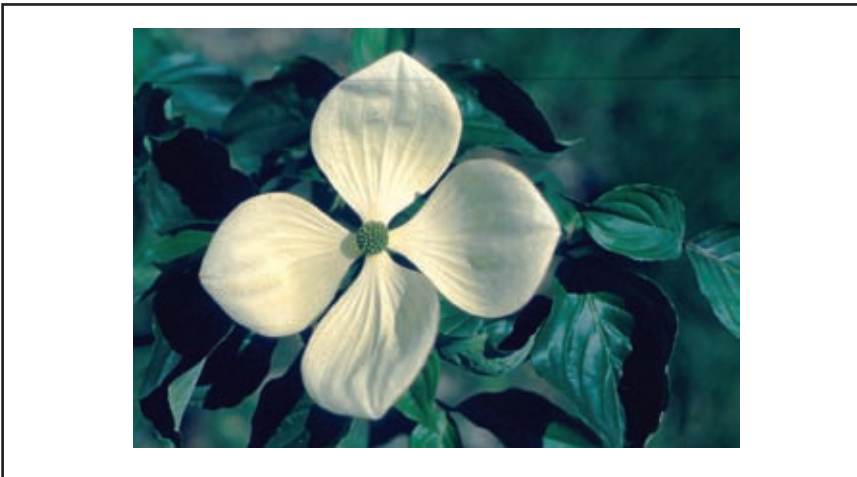
In the Woody Ornamentals Breeding Program at Cook College/NJAES at Rutgers University, interspecific hybridization of *C. kousa* × *C. florida* in 1970 resulted in the introduction of six F1 hybrids, all of which provide an attractive floral display during a time period that is intermediate to that of the two parental species. All six hybrids are very vigorous, exhibit high resistance to the common dogwood borer and to *Discula destructiva*, the incitant of dogwood anthracnose, and exhibit moderate to high resistance to the fungal incitants of powdery mildew. Being highly cross-sterile, as well as self-incompatible, the plants are very floriferous every year since the nutritional drain of a heavy crop of seed that causes many cross-fertile dogwoods to set few flower buds in alternate years does not occur. The trademark names of these dogwood hybrids are Aurora®, Celestial®, Constellation®, Stardust®, Stellar Pink®, Ruth Ellen®, and are marketed as members of Rutgers' Stellar® series of hybrid dogwood (*C. kousa* × *C. florida*).

Dogwood anthracnose was observed first in the mid-1970s in Connecticut and New York and by the late 1980s was ravaging native stands of *C. florida* throughout its native range. But, by the mid to late 1990s, the severity of this disease declined in nonmountainous areas and in recent years has been displaced as the major disease of *C. florida* by the sudden onset of severe epidemics of powdery mildew. Fortunately, the Stellar dogwoods, with their high levels of insect and disease resistance, reached the marketplace at the right time. Now a seventh member of the Stellar series has been introduced, namely, *Cornus* KF1-1, Saturn™ hybrid dogwood PPAF. This clone was given a high rating at the time the first six cultivars were introduced, but was held back on the advice of some who thought it might be counterproductive to introduce so many new dogwoods to commerce at one time. However, after 35 years of being grown under conditions of very low maintenance, including never having been sprayed with any chemical pesticide, the original plant of Saturn hybrid dogwood is performing well. Under similar growing conditions, most plants of *C. florida* would have died years ago. Hence, the decision to add Saturn hybrid dogwood to our list of Stellar hybrids.

As was the case with the first six cultivars in the Stellar series, plants of Saturn hybrid dogwood are very vigorous, highly floriferous but cross-sterile and self-incompatible, exhibit high resistance to the incitants of dogwood anthracnose and powdery mildew, and are fully winter hardy in USDA Hardiness Map Zone 6a [-10 °F (-23.3 °C)]. In central New Jersey, the period of floral display of plants in the Stellar series is intermediate to that of plants of the parent species: i.e., the periods



**Figure 1.** Original plant of Venus™ hybrid dogwood in flower.



**Figure 2.** Close-up of the flower of Venus™ hybrid dogwood in flower.

typically being 29 April to 14 May for plants of *C. florida*, 14 to 29 May for the hybrids, and 28 May through late June and into July for *C. kousa*.

The second new release from Rutgers University is *C. florida* 'Rutnut', Red Pymy® flowering dogwood, PPAF. This introduction is the first truly dwarf, red-bracted cultivar of *C. florida*, the floral bracts of which are as dark red as those of *C. florida* 'Cherokee Chief'. The plants appear to be slightly more vigorous than the white-

bracted cultivar, 'Pygmy', that has been in the trade for many years. The mature size, of course, is not known as yet, but we expect the typical size in a landscape setting will not exceed 2.3 m (7 ft tall) and 2.59 m (8½ ft in width). Typically the plants increase in height about 10 cm (4 inches) a year.

Mr. Don Shadow of Shadow Nursery, Winchester, Tennessee, reports that the plants of Red Pygmy flowering dogwood grown at his nursery have been precocious in flowering. In his experience, 1-year budded liners 15–20 cm (6–8 inches) tall bare-rooted in the fall and potted in one-gallon containers, were 30–35 cm (12–14 inches) tall with as many as 8 to 12 flower buds set at the end of the next growing season. Mr. Shadow reports that he has seen no evidence of dogwood anthracnose on plants of Red Pygmy flowering dogwood but did observe a little powdery mildew on them in 2005. He noted that powdery mildew was very severe on many cultivars of *C. florida* during the 2005 growing season.

The next two *Cornus* hybrids recently introduced by Rutgers University resulted from a program of interspecific hybridization of plants of *C. kousa* and *C. nuttallii*, initiated in May 1973 by the senior author, and are the first-ever reported hybrids of these two species. *C. nuttallii* is native to limited areas of the Pacific Northwest and Western United States. With some plants reaching a height of 21.3 m (70 ft) in areas of the Columbia River Gorge, *C. nuttallii* is the giant of the large-bracted dogwoods. However, plants of this species seldom prosper outside the limited areas to which the species is indigenous. In the absence of any report that plants of *C. kousa* and *C. nuttallii* were cross-fertile, the challenge was to produce interspecific hybrids that exhibited the desirable traits of both species and would grow well over a wide range of soil and climatic conditions.

Numerous seedlings resulting from crosses of *C. kousa* × *C. nuttallii* germinated in 1974 and were containerized for 1 year prior to field planting in Spring 1975. Many of the plants were winter-killed during the first winter in the field. Others grew vigorously in subsequent years but suffered bark split on the south and/or southwest side of the trunk during cold winters. In spite of this localized damage, plus the fact that the trees received minimal care (grown in sod, never irrigated, and never sprayed with chemical pesticides), about 20 plants were evaluated for 15 to 25 years. Most of the plants flowered after 7 to 9 years, and on 2 June 1983, a superior F1 hybrid of *C. kousa* var. *chinensis* × *C. nuttallii* 'Gold Spot' was hybridized with a plant of *C. kousa* 'Rosea'. Subsequently, the "best" seedling among the progeny from this cross was propagated and distributed to cooperators in New Jersey, Tennessee, and Oregon for further evaluation. That cultivar now has plant patent applied for status and is being marketed as KN30-8, Venus™ hybrid dogwood. Plants of this hybrid are distinguished by their exceptional vigor, excellent dark green leaves, and the largest white floral bracts the authors have ever seen on a dogwood plant (Figs. 1 and 2). At 20 years of age, the original seedling was 5.48 m (18 ft) tall with a spread of 6.55 m (21.5 ft). The original seedling has been field tested for 19 years in central New Jersey (USDA Zone 6a) with no observable winter injury and has shown good tolerance of drought conditions and high resistance to the incitants of powdery mildew and dogwood anthracnose. Venus hybrid dogwood has been introduced as the first member of Rutgers' Jersey Star™ series of hybrid dogwood (*C. kousa* × *C. nuttallii*).

*Cornus* KN4-43, Starlight® Jersey Star® series dogwood, PPAF has been introduced as the second member of our Jersey Star® series. This cultivar originated as

an F1 hybrid resulting from a cross of *C. kousa* 'Simpson No. 1' × *C. nuttallii* 'Gold Spot'. The original plant is extremely vigorous and dense, having reached a height of 8.83 m (29 ft) with a columnar spread of 7.07 m (23.25 ft) in 30 years. Plants of Starlight hybrid dogwood are vegetatively winter-hardy in USDA Zone 6a but are flower bud hardy only to USDA Zone 7b [+5 °F (-15 °C)]. The plants have shown high resistance to the major disease and insect pests of *C. kousa* and *C. nuttallii*, exhibit attractive, dark green leaves, and have been found to be floriferous in Winchester, Tennessee, and Boring, Oregon. Plants of Starlight hybrid dogwood have not been extensively tested in the Mid-Atlantic and south-eastern states, but their performance in these and other areas of the United States will be forthcoming soon.

---

## Developments in Production and Use of Trees, Shrubs, and Perennials<sup>®</sup>

### Gert Fortgens

Honingerdijk 86, Rotterdam, 3062 NX, The Netherlands

The nursery trade currently is faced with some problems in The Netherlands. These include:

- 1) There are currently too many taxa of plants to choose from. This is creating problems for both nurseries and gardeners. This has resulted from:
  - a) Too many NEW NEW NEW plants.
  - b) Too many old (and/or unknown) plants.

Therefore, this has resulted in the need to distinguish products by marketing tools: labels, pots, and trays.

- 2) Pests and diseases.
  - a) Problems in nurseries.
  - b) Problems in urban and rural areas.

What needs to happen: we need to spread the risks by diversifying production and plant a wider range of plants.

- 3) Trends in gardening are causing problems and include the following:
  - a) Less-is-more garden design with use of fewer plants (are perennials "out"?).
  - b) Bringing inside living room outside: this has led to plants in pots with lots of hardware/furniture.
  - c) Short-term gardening.
  - d) Buying visually attractive plants only.

To overcome the above problems, consumers need more information on the wealth of plants to choose from. Suppliers of information include the following:

- The nursery trade itself.
- Inspection Service for Horticulture (NAK).
- For woody ornamentals and perennials: Royal Boskoop Horticultural Society (KVBC), which has been conducting trials for many years. The distribution of information is through Plant Publicity Holland.



an F1 hybrid resulting from a cross of *C. kousa* 'Simpson No. 1' × *C. nuttallii* 'Gold Spot'. The original plant is extremely vigorous and dense, having reached a height of 8.83 m (29 ft) with a columnar spread of 7.07 m (23.25 ft) in 30 years. Plants of Starlight hybrid dogwood are vegetatively winter-hardy in USDA Zone 6a but are flower bud hardy only to USDA Zone 7b [+5 °F (-15 °C)]. The plants have shown high resistance to the major disease and insect pests of *C. kousa* and *C. nuttallii*, exhibit attractive, dark green leaves, and have been found to be floriferous in Winchester, Tennessee, and Boring, Oregon. Plants of Starlight hybrid dogwood have not been extensively tested in the Mid-Atlantic and south-eastern states, but their performance in these and other areas of the United States will be forthcoming soon.

---

## Developments in Production and Use of Trees, Shrubs, and Perennials<sup>®</sup>

### Gert Fortgens

Honingerdijk 86, Rotterdam, 3062 NX, The Netherlands

The nursery trade currently is faced with some problems in The Netherlands. These include:

- 1) There are currently too many taxa of plants to choose from. This is creating problems for both nurseries and gardeners. This has resulted from:
  - a) Too many NEW NEW NEW plants.
  - b) Too many old (and/or unknown) plants.

Therefore, this has resulted in the need to distinguish products by marketing tools: labels, pots, and trays.

- 2) Pests and diseases.
  - a) Problems in nurseries.
  - b) Problems in urban and rural areas.

What needs to happen: we need to spread the risks by diversifying production and plant a wider range of plants.

- 3) Trends in gardening are causing problems and include the following:
  - a) Less-is-more garden design with use of fewer plants (are perennials "out"?).
  - b) Bringing inside living room outside: this has led to plants in pots with lots of hardware/furniture.
  - c) Short-term gardening.
  - d) Buying visually attractive plants only.

To overcome the above problems, consumers need more information on the wealth of plants to choose from. Suppliers of information include the following:

- The nursery trade itself.
- Inspection Service for Horticulture (NAK).
- For woody ornamentals and perennials: Royal Boskoop Horticultural Society (KVBC), which has been conducting trials for many years. The distribution of information is through Plant Publicity Holland.

Royal Boskoop Horticultural Society trials are organized as follows:

**New Cultivars.** These trials include their own finds or imports and are judged by a committee of specialists. The plants are judged on the following points:

- Is the plant new?
- Is the plant different or distinguishable?
- Does it have market potential?
- How does it propagate and grow (healthy)?
- Performance in the nursery.

Good plants receive an award. The results are meant for the nursery trade and are published in *Dendroflora*. Because new plants are hot, a lot of attention is focused on them by the press. This leads to the problem of availability.

### JUDGING NEW PLANTS AT SHOWS

This leads to more attention on the show quality of the plant than on garden plant quality.

**Merit Stars Trials.** These are judged by a committee of specialists. These trials are conducted according to the following procedures:

- Field trials, 3–5 years, different soils in Holland.
- By genus or type of plants.
- Assessment of a range of aspects: vigour, performance, healthiness, hardiness, compare cultivars, identify cultivars, describe cultivars.
- Results published in *Dendroflora*.
- Although aimed for nursery trade, results are useful for (and used by) professional and amateur horticulturists as well.

**New Initiative: EURO-TRIALS.** There are many trialling organizations in different European countries. However, there is no communication or cooperation, resulting in duplication in the trials. The idea emerges of “why not get together?”

A pilot project, initiated and coordinated by KVBC, was started Spring 2005 in Great Britain, France, Germany, and Holland to evaluate *Hydrangea paniculata* cultivars. The judging committees were composed of nurserymen and consumer panels. The advantages are more information on performance (different climates), taste, and good promotional activity. A follow up activity is planned with *Buddleja* (under German coordination), and there is interest in participation from Austria, Sweden, Denmark, and Italy.

**Promotion of Good Plants.** Promotion of good plants can only be successful when a plant is available! There are two problems:

- New and unobtainable.
- Old, but good...not widely known, not in production so not obtainable.

We need to upgrade the award system: it has to be nominated. The advantages of this system would be:

- 1) It has proven itself by several years of experience (checked by specialists).
- 2) It has to be readily available (checked by tradespeople).

If it meets the above two criteria than it is a PLANT PLUS! plant.

## Some Common Misconceptions About Seed Dormancy®

Robert L. Geneve

Department of Horticulture, University of Kentucky, Lexington, Kentucky 40546 U.S.A.

### INTRODUCTION

Dormancy is a condition where seeds will not germinate even when the environmental conditions (water, temperature, light, and aeration) are permissive for germination (Hartmann et al., 2002). Seed dormancy prevents immediate germination but also regulates the time, conditions, and place where germination will occur. In nature, different kinds of primary dormancy have evolved to aid the survival of a species by programming germination for particularly favorable times in the annual seasonal cycle. Horticulturists apply dormancy-release treatments to facilitate the cultivation of dormant species. The objective of this paper is to describe the major types of seed dormancy and present some of the common misconceptions associated with these dormancy types (Table 1).

### MAJOR SEED DORMANCY CATEGORIES

Major seed dormancy categories include:

- 1) Primary dormancy
  - a) Exogenous dormancy
  - b) Endogenous dormancy
  - c) Combination dormancy
- 2) Secondary dormancy

**Primary Dormancy.** This is a condition that exists in the seed as it is shed from the plant. In contrast, secondary dormancy occurs in seeds that were previously nondormant when the environment is unfavorable for germination.

**Primary Exogenous Dormancy.** Exogenous dormancy is imposed upon the seed from factors outside the embryo including the seed coat and/or parts of the fruit. This type of dormancy is commonly referred to as physical dormancy or hard seeds (Hartmann et al., 2002). Seeds with physical dormancy fail to germinate because the seed is impermeable to water. The outer layer is composed of macrosclereid cells that are responsible for preventing water uptake. Scarification treatments that physically abrade the seed coat or exposure to sulfuric acid are commonly used to alleviate physical dormancy. In nature, exposure to high temperature or extreme fluctuating temperatures is the most likely cause of dormancy release (Geneve, 2003).

Physical dormancy is found in approximately 15 plant families, including Fabaceae, Malvaceae, Cannaceae, Geraniaceae, and Convolvulaceae (Baskin et al., 2000). These seeds usually have a specialized location on the seed (the lens or strophiole) that first becomes permeable to water after dormancy release. Once the seed can imbibe water, it germinates without any further dormancy release treatment.

**Primary Endogenous Dormancy.** Seeds with endogenous dormancy fail to germinate because of factors within the embryo. These factors can be either physiological or morphological.

Endogenous physiological dormancy can be separated into three types based on their “depth” of dormancy. These include nondeep, intermediate, and deep dormancy (Baskin and Baskin, 1998).

**Table 1. Some common misconceptions about seed dormancy.**

Misconception	Current knowledge
Physical dormancy is common in plants.	Physical dormancy is only found in 15 plant families. However, the legume family (Fabaceae) is very large and contains many plants with hard seeds. Mechanical dormancy is a type of physical dormancy. The removal of the embryo from the surrounding seed coverings permits germination in most dormant seeds. This indicates that the surrounding tissues present a physical barrier to germination. However, it is felt that this barrier is not the cause of dormancy and factors within the embryo cause an increase in the growth potential of the embryo that allows it to penetrate the seed coverings.
Seeds will stratify if placed dry in the refrigerator.	Stratification will only occur when seeds are above 25% moisture.
After-ripening is a term to describe any dormancy treatment for physiological dormancy.	Originally in the older literature after-ripening was applied to any dormancy breaking treatment that involved periods of warm or cold storage. However, most seed biologists use after-ripening only to describe dormancy release in <i>dry</i> warm storage and stratification to describe <i>moist</i> warm or cold storage.
After-ripening is a common natural form of dormancy release.	Dormancy loss in temperate climates for seeds with physiological dormancy is most common by warm or cold stratification. However, anytime the seed spends dry (< 20%) and warm will reduce the time required for stratification. Rather than being the primary dormancy release treatment, after-ripening probably functions to modify the seed dormancy state. In desert or tropical environments with extended periods of dry warm conditions, after-ripening can be the primary treatment for seed dormancy release.
Most dormant woody species have deep physiological dormancy.	This type of dormancy only occurs in a few species. The key difference between intermediate and deep physiological dormancy is that the embryo fails to germinate when removed from the seed coverings from seeds with deep physiological dormancy.
Photodormancy is a type of primary dormancy.	Seed biologists feel that light is only a limiting environmental factor for germination similar to temperature and is not a type of dormancy.
Seeds with morphological dormancy that require only warm stratification to germinate are not really dormant.	Seed ecologists consider these seeds dormant because they require more than 30 days to germinate, the embryo fills less than ½ of the mature seed, and the embryo must grow inside the seed before the radicle can emerge.

---

Double dormancy is the same as combinational dormancy.	Double dormancy was a term used by Barton in 1945 to describe epicotyl dormancy. "Double" refers to the multiple years required for germination. Combinational dormancy occurs in seeds that have physical plus physiological dormancy.
Seeds that do not germinate at high temperatures are in secondary dormancy.	After exposure to high temperature, seeds are considered to exhibit <i>thermo</i> inhibition if the seeds will germinate when returned to normal temperatures. In contrast, seeds that will not germinate when returned to normal temperatures are considered <i>thermo</i> dormant.
Seeds are either dormant or nondormant.	We can only describe dormancy by observing germination. Therefore, if the germination conditions are not favorable the seeds will appear to be dormant. Therefore, in a population of seeds, some may exhibit deeper dormancy than others. Those with shallow dormancy may germinate over a wide range of temperatures, while those with deeper dormancy may not germinate or will germinate only at the optimal temperature. Seed biologists term this conditional dormancy.

---

Nondeep physiological dormancy is the most common form of dormancy found in seeds. It is alleviated in nature by short periods of warm or cold stratification. They also lose their dormancy after a period of warm, dry storage that is usually called after-ripening. After-ripening is a simple treatment that is applied to many commercial vegetable and flower seeds to relieve dormancy prior to sale to the consumer (Geneve, 1998).

Seeds with intermediate physiological dormancy require up to 12 weeks of cold stratification to alleviate dormancy, while those with deep physiological dormancy require more than 12 weeks. In addition, a major distinction between these two classes of seed dormancy is that the embryos removed from the seed coverings will grow normally from seeds with intermediate physiological dormancy, but isolated embryos from seeds with deep physiological dormancy will fail to germinate or will grow as physiological dwarfs (Flemion and Waterbury, 1945). Seeds of this type ripen in the fall, overwinter in the moist leaf litter on the ground, and germinate in the spring.

A second type of primary endogenous dormancy is morphological dormancy. Morphological dormancy occurs in seeds where the embryo is not fully developed at the time of seed dissemination. Enlargement of the embryo occurs after the seeds have imbibed water and before germination begins. Embryo growth usually occurs by imbibing seeds at warm temperature. Embryo development can take weeks to months to be completed before seedlings finally emerge.

The most complex form of primary endogenous dormancy is displayed by seeds with morphophysiological dormancy (Baskin and Baskin, 1998). These seeds have underdeveloped embryos as is seen in morphological dormancy, but once the embryo fully develops, the seed remains dormant because of a physiological dormancy condition. The simplest example of seeds with morphophysiological dormancy re-

quire warm ( $> 15^{\circ}\text{C}$ ) temperature to permit embryo growth followed by cold (1 to  $10^{\circ}\text{C}$ ) temperature conditions to break physiological dormancy. The most extreme example is epicotyl dormancy. These seeds have separate dormancy conditions for the radicle and epicotyl. Seeds require a chilling period to relieve radicle dormancy, followed by a warm period to allow the radicle to grow, then a second cold period to release the epicotyl from dormancy. In nature, such seeds require at least two full growing seasons to complete germination. Examples include bloodroot (*Sanguinaria*), *Trillium*, and lily-of-the-valley (*Convallaria*).

**Primary Combinational Dormancy.** Seeds with combinational dormancy have both physical and physiological dormancy. To relieve dormancy the seed coat must be scarified to permit imbibition, and then exposure to chilling stratification can release the seed from physiological dormancy. This is an uncommon dormancy type found in only a few species including buttonbush (*Ceanothus*), redbud (*Cercis*), golden raintree (*Koelreuteria*), sumac (*Rhus*), and linden (*Tilia*).

**Secondary Dormancy.** In nature, primary dormancy is an adaptation to control the time and conditions for seed germination. However, if the environment is unfavorable for germination, the seeds may enter secondary dormancy (Khan, 1981). Secondary dormancy can be induced by high temperature, non-appropriate light exposure, or lack of oxygen.

The most common cause of secondary dormancy in nature is from light exposure. Many seeds require light for germination. If a seed is released from endogenous dormancy, but light is unavailable (such as deep burial in the soil) the seed will eventually enter secondary dormancy. This could lead to many years of dormancy cycling where the seed is released from dormancy but forced back into dormancy due to unfavorable light conditions.

Some commercially important species display thermodormancy when the germination temperatures are too high (Geneve, 1998). These include lettuce, celery, and pansy. To avoid thermodormancy, these species are either primed prior to sowing or grown from transplants.

## LITERATURE CITED

- Barton, L.B.** 1944. Some seeds showing special dormancy. *Contrib. Boyce Thompson Inst.* 13:259–271.
- Baskin, C.C., and J.M. Baskin.** 1998. *Seeds, Ecology, biogeography, and evolution of dormancy and germination.* Academic Press, New York, New York.
- Baskin, J.M., C.C. Baskin, and X. Li.** 2000. Taxonomy, anatomy and evolution of physical dormancy in seeds. *Plant Species Biol.* 15:139–152.
- Flemion, R., and E. Waterbury.** 1945. Further studies with dwarf seedlings of non-after-ripened peach seeds. *Contrib. Boyce Thompson Inst.* 13:415–422.
- Geneve, R.L.** 1998. Seed dormancy in commercial vegetable and flower seeds. *Seed Technol.* 20:236–249.
- Geneve, R.L.** 2003. Impact of temperature on seed dormancy. *HortScience* 38:336–341.
- Hartmann, H.T., D.E. Kester, F.T. Davies, Jr., and R.L. Geneve.** 2002. *Hartmann and Kester's plant propagation: Principles and practices* 7th ed. Prentice-Hall, Inc., Englewood Cliffs, New Jersey. Seventh edition.
- Khan, A.A.** 1981. Hormonal regulation of primary and secondary dormancy. *Israel J. Bot.* 29:207–224.
- Nikolaeva, M.G.** 1977. Factors affecting the seed dormancy pattern, p. 51–76. In: A.A. Khan (ed.). *The physiology and biochemistry of seed dormancy and germination.* North-Holland Pub., Amsterdam.

## Chanticleer — A Plant-Geek Pleasure Garden®

### R. William Thomas

Chanticleer, 786 Church Rd, Wayne, Pennsylvania 19087 U.S.A.

Chanticleer is a pleasure garden with a staff of creative, design-oriented plant geeks. Located 20 min. west of Philadelphia, Chanticleer was the estate of the Rosengarten family from 1912–1990. When the last owner, Adolph Rosengarten, Jr., died in 1990, the property of majestic trees and beautiful lawns was turned over to a Foundation to be run as a public garden. Almost all of the “garden” development has happened in the last 15 years. The design, with a strong emphasis on plants, has been led by staff.

A tour of Chanticleer begins in the Teacup Garden, named after its central water feature. Here, as in most of the property, foliage color and texture provide most of the interest, with flowers as accents. Light colors, such as chartreuse, orange, and silver, play off various shades of purple throughout the garden. Here in the Teacup Garden, glaucous agaves grow near purple alternantheras, and *Dichondra argentea* ‘Silver Falls’ cascades below *Cordyline australis* ‘Red Sensation’. A new plant for us this year was *Sprekelia formosissima*, a summer-blooming Mexican bulb, mixed in plantings of *Lavandula x intermedia* ‘Grosso’ and *Arundo donax* var. *versicolor*.

The Tennis Court Garden is entered by a stone staircase with a planted railing and features plantings of yellow and purple. Among the yellows are *Deutzia gracilis* ‘Duncan’, Chardonnay Pearls™ deutzia, *Chamaecyparis pisifera* ‘Filifera Aurea Nana’, *Cercis canadensis* ‘Roethgold’, Hearts of Gold™ redbud, *Spiraea thunbergii* ‘Ôgon’ [Mellow Yellow spiraea], *Picea orientalis* ‘Skylands’, and *Carex elata* ‘Aurea’ (syn. ‘Bowles’ Golden). These contrast with the dark leaves of *Physocarpus opulifolius* ‘Diabolo’ PBR, *Cercis canadensis* ‘Forest Pansy’, *Cotinus cogggyria* ‘Velvet Cloak’, and *Weigela florida* ‘Alexandra’ [Wine and Roses® weigela].

Nearby, the trees of the old orchard have been replaced with crabapples and flowering cherries and underplanted with nearly 150,000 spring flowering bulbs. Following bloom, the bulb foliage is allowed to mature until the end of June, resulting in tall, unmown grass. We are experimenting with seed mixes of hard fescues, which mature at about 8 inches.

The main house sits on a hill south of the orchard. The house’s entrance court is a circle of reddish brown gravel, raked daily. The gravel patterns, which can change daily, are particularly effective when highlighted by the falling petals of the surrounding *Prunus* ‘Accolade’. A sun porch off the side of the house welcomes visitors to sit and feel as if they were special guests of the Rosengartens.

South-facing terraces extend from the back of the house. Here containers reign supreme, with celebrations of orange and yellow and contrasting touches of purple-black. Much of the orange comes from the *Solenostemon* (coleus) cultivars ‘Rustic Orange’ and ‘Sedona’ and *Begonia boliviensis* ‘Tanais’®. The yellows include *Cotinus cogggyria* ‘Ancot’, Golden Spirit™ smoke bush PBR, *Leycesteria formosa* ‘Notbruce’, Golden Lanterns® Himalayan honeysuckle, *Phygelius xrectus* ‘Moonraker’, *Hedera helix* ‘Buttercup’, *Xanthosoma* ‘Lime Zinger’, and *Hakonechloa macra* ‘All Gold’. The dark foliage of *Colocasia* ‘Black Dragon’, *Aeonium urbicum* ‘Zwartkop’, and *Colocasia esculenta* ‘Illustris’ (syn. *Alocasia antiquorum* ‘Illustris’) completes the effect.



A reflecting pool is lined with *Cyperus papyrus* and, nearby, ceramic rooster-inspired bamboo emerges from a group of *Hibanobambusa tranquillans* 'Shiroshima'. A winding path takes one down the great lawn to serpentine beds of dwarf amber sorghum, edged with *Juniperus virginiana* 'Corcorcor', Emerald Sentinel™ eastern red cedar.

At the bottom of the hill is the pond garden, filled with exuberant flowers, while in the water itself are hardy *Nymphaea* and *Nelumbo* 'Mrs. Perry D. Slocum'. A nearby bog garden is filled with species and hybrids of hardy pitcher plants, *Sarracenia*.

Asian Woods, at the far western end of the estate, brings cool shade to the visit. The area features plants from China, Korea, and Japan. Here one meets the stream that runs the entire northern side of the garden. Growing in the wet areas are *Petasites japonica* (kept controlled by the creek) and *Lysichiton americanus* and *L. camtschatcensis*.

Further upstream is a hillside of native wildflowers shaded by *Cercis canadensis* and *C. canadensis* f. *alba* (syn. 'Alba'). The stream itself here is lined with masses of *Camassia*. On a hill above the stream is the Ruin Garden, viewed first through a sea of *Sporobolus heterolepis*. The Ruin features plants with dark green leaves (including *Ilex crenata* 'Sky Pencil' and *Cephalotaxus harringtonii* 'Fastigiata') contrasted with silvers of dichondra and purples of maples and beeches. A dry garden stretches westward down the slope, featuring a combination of native (such as *Asclepias tuberosa*) and exotic (*Stapelia gigantea* and *Eschscholzia californica*) plants in gravel beds. The tour ends at a cutting and vegetable garden, edged with a 210-ft-long hedge of asparagus.

Chanticleer's gardeners lead the design process, enabling the garden to feel personal and showing great creativity. Almost any plant is welcomed, but is always placed carefully and with lots of thought to aesthetics. There are no "behind-the-scenes" research areas; instead, plants are trialed on location. The garden is open April through October, Wednesday through Sunday. Professionals in the horticulture and landscape industries receive free admission.

# Rooting Cuttings Hydroponically in Compost Tea and Wastewater<sup>®</sup>

**C. Chong and J. Yang**

Department of Plant Agriculture, University of Guelph, Guelph, Ontario, Canada N1G 2W1

**B. Holbein and H.-W. Liu**

Super Blue Box Recycling (SUBBOR) Corporation, Etobicoke, Ontario, Canada M8V 3Y3

**R.P. Voroney**

Department of Land Resource Science, University of Guelph, Guelph, Ontario, Canada N1G 2W1

**H. Zhou**

School of Engineering, University of Guelph, Guelph, Ontario, Canada N1G 2W1

**Cuttings of sage, currant, euonymus, and weigela were rooted in aerated compost tea, anaerobic digestion process wastewater, and a control nutrient solution, each diluted to various electrical conductivity (salt) levels between 0 and 0.5 dS·m<sup>-1</sup>. For sage, the highest percent rooting, root number, and root length occurred at 0.34, 0.38, and 0.30 dS·m<sup>-1</sup>, respectively. Values for the other species varied from 0.25 to 0.5 dS·m<sup>-1</sup> depending on rooting criterion. Despite these differences, trends in rooting tended to be similar with the three solution sources. The results indicate that, with proper dilution to reduce salts, compost tea and wastewater can be recycled as irrigation water or nutrient source for cuttings during propagation.**

## INTRODUCTION

Fertilizer and water usage and run-off from farms and nurseries have emerged into issues of primary concern to the nursery industry. Since 1984, the environmentally friendly ornamental research program at the former Horticultural Research Station of Ontario (now part of the University of Guelph) has focused research on how to effectively reutilize and recycle organic waste by-products and garbage-derived composts in container and rooting substrates (Chong, 2005). In the 1990s, the program expanded to include closed system recirculation of nutrients and wastewater recycling for container growing (Chong et al., 2004; Gils et al., 2004), and began to examine wastewater from another perspective — use of leachates and runoff water from compost operations as irrigation and supplemental fertilizer source. We successfully grew nursery trees and grasses irrigated with pond-collected compost leachates (Jarecki, 2002); tomato and marigold seedlings with compost leachates in hydroponic culture (Jarecki et al., 2005); and nursery liners and turfgrasses in hydroponic culture using various compost teas and process wastewater from anaerobic digestion (Michitsch et al., 2005).

The objective of this study was to examine and compare rooting of four species in solutions amended with compost tea and anaerobic digestion wastewater.

## MATERIALS AND METHODS

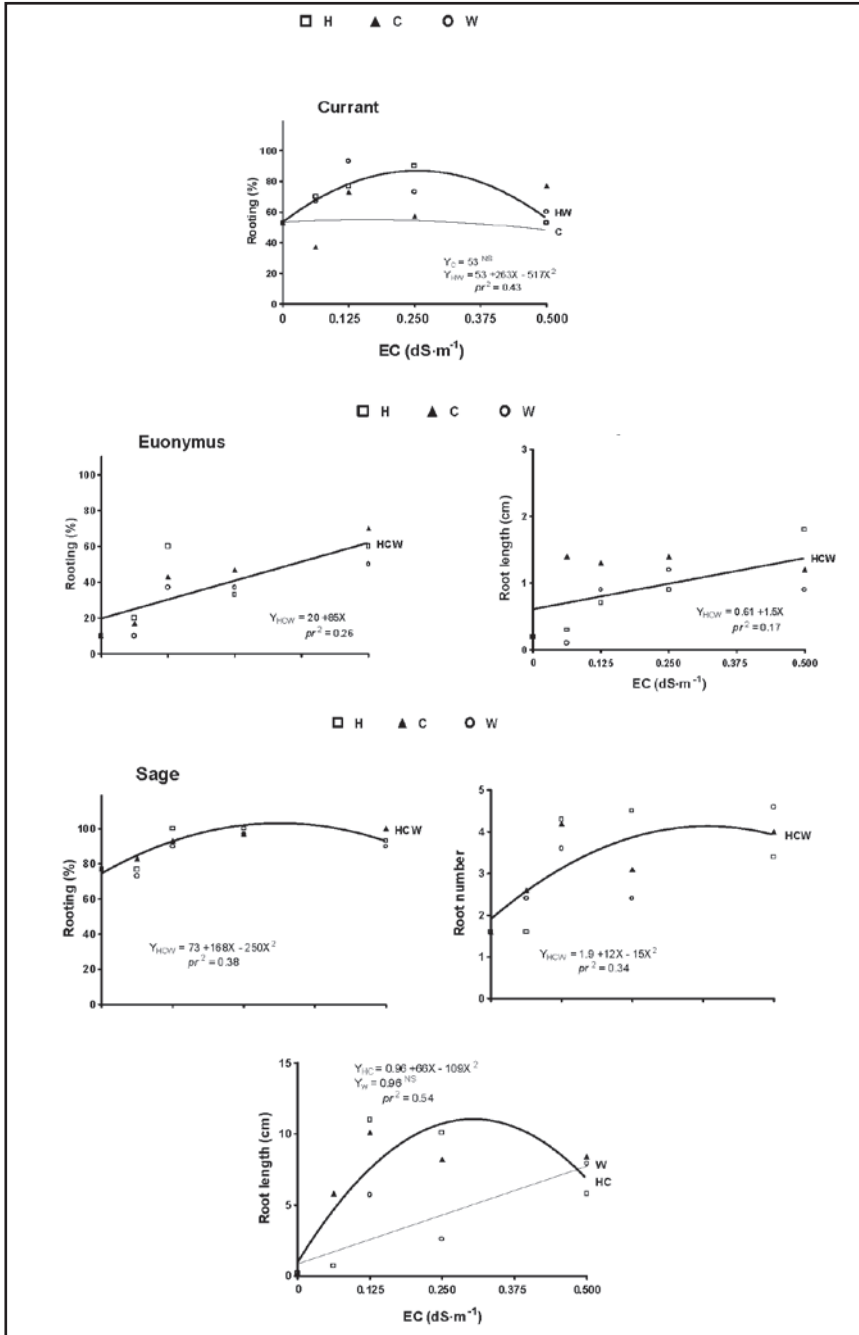
Compost tea [initial electrical conductivity (EC, a measure of soluble salts concentration)  $2.3 \text{ dS}\cdot\text{m}^{-1}$  and pH 7.8] was obtained by pouring 21 L of deionized water over 4 L of municipal solid waste compost (Guelph Waste Resource Innovation Center, Guelph, ON) and filtering through a 1.5 mm screen. Process wastewater (initial EC  $19 \text{ dS}\cdot\text{m}^{-1}$  and pH 8.7) was obtained from an anaerobic digestion pilot facility [Super Blue Box Recycling (SUBBOR) Corporation, Guelph, Ontario], which uses the same source of municipal solid waste as a feedstock to produce biogas for electricity generation. Both tea and wastewater were stored at  $4^\circ\text{C}$  until required for use. Table 1 shows the chemical composition of the tea and wastewater, both at EC of  $0.5 \text{ dS}\cdot\text{m}^{-1}$ .

**Table 1.** Chemical composition<sup>2</sup> of three sources of nutrient solution at EC  $0.5 \text{ dS}\cdot\text{m}^{-1}$ .

Nutrient (ppm)	Desirable values for irrigation of greenhouse substrates	Hoagland's solution	Compost tea	Process wastewater
$\text{NO}_3\text{-N}$	<5	43	7	4
$\text{NH}_4\text{-N}$	-	3	3	35
P	<5	6	0.7	0.4
K	<10	51	27	20
Ca	<60	34	3	0.3
Mg	<25	10	0.2	<1
Na	<60	4	33	45
Cl	<100	1	39	42
$\text{SO}_4$	<200	47	12	3
Zn	<0.5	0.03	0.04	0.01
Mn	<1.0	0.09	0.03	<0.01
Cu	<0.2	0.08	0.02	0.01
Fe	<5	1.08	0.68	0.14
B	<0.5	0.10	0.03	0.11
Mo	<0.1	0.01	0.1	0.02

<sup>2</sup>Mean of duplicate samples.

Cuttings of sage (*Salvia officinalis* 'Tricolor'), currant [*Ribes odoratum* (syn. *aureum*)], euonymus (*Euonymus fortunei* var. *vegetus*), and weigela (*Weigela* 'Nana Variegata') were prepared 4–5 cm tall with a node at the base. Leaves were removed from the lower half, and the remaining ones cut in half to reduce surface area. Cuttings were then inserted through 2.5 cm thick  $\times$  22 cm  $\times$  22 cm Styrofoam platforms and rooted hydroponically under greenhouse conditions (40% shade, daylight misting,  $25^\circ/20^\circ\text{C}$  day/night temperature, and 16-h photoperiod) in 3-L pots (17.5 cm diam.  $\times$  18 cm deep, no drainage holes) with their bases immersed in continuously aerated treatment solutions: deionized water ( $0 \text{ dS}\cdot\text{m}^{-1}$ ), or compost tea, process wastewater, and



**Figure 1.** Rooting performance of currant, sage, and euonymus cuttings in response to various EC levels in Hoagland's control nutrient solution (H), compost tea (C), and anaerobic digestion wastewater (W).

Hoagland's (control) nutrient solution (Hoagland and Arnon, 1938), each diluted with deionized water to EC of 0.0625, 0.125, 0.25, and 0.5 dS·m<sup>-1</sup>.

Rooting was assessed by three criteria: percent rooting; number of roots per rooted cutting; and length of the longest root per cutting. For each species [rooting period and days in brackets: sage (20 April–17 May; 27 days); currant (7 July–28 July; 21 days); euonymus (22 July–25 Aug.; 34 days); and weigela (5 Aug.–30 Aug.; 25 days)], pots were arranged in a randomized complete block design. There were 3 replications of the 14 treatment solutions and 10 cuttings per pot (platform). All solutions were adjusted twice daily to pH of 6.5 and changed weekly. Rooting responses were regressed over salt levels. For each species, the model represents graphically three linear or quadratic curves, one for each solution source (tea, wastewater, or Hoagland's), radiating from a common intercept. A common regression was fitted when two or more curves were not significantly different at  $P \leq 0.05$ . The coefficient of determination for each set of responses was expressed in terms of partial  $r^2$  ( $pr^2$ ), which measured the strength of the response relationship after removing replication effects.

## RESULTS

Despite differences in species response, rooting tended to be similar with the three solution sources. Sage rooting percent and root number (Fig. 1) increased curvilinearly and similarly with nutrient sources (common regression curve, 100% rooting at 0.34 dS·m<sup>-1</sup>, and 4.1 roots at 0.38 dS·m<sup>-1</sup>, respectively), as did also root length with the compost tea and Hoagland's (common curve for these two nutrient sources, 11.0 cm at 0.30 dS·m<sup>-1</sup>), but was unresponsive to wastewater. Currant rooting percent increased curvilinearly and similarly with nutrient sources (87% calculated maximum rooting at 0.25 dS·m<sup>-1</sup>) (Fig. 1), but root number and length were unresponsive. Euonymus rooting percent increased linearly with increasing EC and was similar with all three sources (61% rooting at 0.5 dS·m<sup>-1</sup>), as did also root length (1.4 cm at 0.5 dS·m<sup>-1</sup>), but root number was unresponsive. Weigela was unresponsive to EC or nutrient sources (mean percent rooting, 73; root number, 6.5; and root length, 1.9 cm).

## DISCUSSION

While compost teas and wastewaters have been used for growing plants (Michitsch et al., 2005; Riggle, 1996; Scheuerell and Mahaffee, 2003), to our knowledge their use in plant propagation appears to be novel. Major deterrents for considering using these materials in propagation include lack of knowledge about usage and potential phytotoxicity due to excessive individual nutrients or salts.

Cuttings are typically sensitive to salts, although detailed information about species threshold tolerance is sparse. Chong (2002) observed no negative effect when soluble salts concentrations in rooting media are  $\leq 0.2$  dS·m<sup>-1</sup> [as determined by measuring EC in 1 substrate : 2 water (v/v) extracts] were used for rooting stem cuttings during the summer, although greenhouse-rooted hardwood cuttings during winter may be tolerant of higher salt levels (0.7 dS·m<sup>-1</sup>).

In this study, maximum rooting response varied with species and rooting criteria at salt levels from 0.25 to at least 0.5 dS·m<sup>-1</sup>, the highest level tested. This evidence indicates that, in addition to species, different rooting criteria respond differently to salt level. Unlike sage (a greenhouse-grown herbaceous plant) and currant (softwood cuttings taken in early spring), cuttings of euonymus and weigela were taken

later in the season. This observation suggests that higher salt tolerance may also be related to seasonal differences associated with increasing hardness of the cuttings.

The presence of growth regulators observed or speculated to be present in waste by-products and composts (Chong, 2002) was unlikely in the solutions since responses were at most similar to Hoagland's, a balanced nutrient solution. The enhanced rooting responses where observed were due most likely to nutrients present (Table 1). The reduced root length with sage and/or lack of increase in rooting percentage of currant in the wastewater may be indicative of the presence of root inhibiting compounds and/or nutrient imbalance. In hydroponic experiments, the wastewater inhibited growth of nursery liners due likely to a slimy deposit on the roots, although the growth of turfgrasses was little affected (Michitsch et al., 2003).

## CONCLUSION

The study shows that, with proper dilutions, compost teas and wastewater can be effectively used in plant propagation, serving as a source of irrigation and supply of small quantities of nutrients for root growth and development. While cuttings are sensitive to salts, small but appropriate amounts and composition can result in enhanced rooting responses.

**Acknowledgments.** Financial support was provided by SUBBOR, a subsidiary of Eastern Power Ltd., the Natural Sciences Engineering and Research Council (NSERC), and the Ontario Ministry of Agriculture and Food (OMAF).

## LITERATURE CITED

- Chong, C.** 2002. Use of waste and composts in propagation: Challenges and constraints. *Comb. Proc. Intl. Plant Prop. Soc.* 52:410-414.
- Chong, C.** 2003. Nutrient recycling and its impact on nursery crop production. Proc. 13th Annu. Mtg. Composting Council of Canada, London, ON, 26-27 Sept. 2003 (available on CD, e-mail: amrc@albedo.net).
- Chong, C.** 2005. Experiences with wastes and composts in nursery substrates. *HortTechnology* 15:739-749.
- Chong, C., G. Lumis, and P. Purvis.** 2004. Growth and nutrient status of six species of nursery stock grown in a compost-based medium with recycled nutrients. *Hort-Science* 39:60-64.
- Gils, J., C. Chong, and G. Lumis.** 2003. Container nursery stock response to recirculated nutrients. *Acta Hort.* 630:219-224.
- Jarecki, M.K.** 2002. Evaluation of compost leachate as a source of irrigation water and nutrients in field and hydroponic experiments. Ph.D. Thesis, Dept. of Land Resource Science, Univ. of Guelph.
- Jarecki, M.K., C. Chong, and R.P. Voroney.** 2005. Evaluation of compost leachate for plant growth in hydroponic culture. *J. Plant Nutrition* 28:651-667.
- Hoagland, D.R., and D.I. Arnon.** 1938. Water culture methods for growing plants without soil. *California Agr. Expt. Sta. Circular* #347.
- Michitsch, R., C. Chong, B.E. Holbein, R.P. Voroney, and H.-W. Liu.** 2003. Use for spent mushroom compost leachate for growing turf and nursery species in hydroponic culture. *Mushroom World* 14(3):21-23.
- Riggle, D.** 1996. Anaerobic digestion for MSW and industrial wastewater. *Biocycle* 37(11):77-81.
- Scheurell, S.J., and W.F. Mahaffee.** 2003. Compost teas for plant disease control: Production, application and results. Proc. ASA-CSSSA-SSSA Annual Meetings, Denver, CO, Nov. 3-6, 2003.

## Plant Propagation — Industry and Development®

**Romel Flores**

Princeton Nursery, PO Box 185, Allentown, New Jersey 08501 U.S.A.

### INTRODUCTION

Propagation is one of the oldest skills; it has been practiced since man stopped roaming the earth and started settling in one spot. Seeds or cuttings were germinated or rooted, plants sold or grown on, and eventually a finished plant became a valuable commodity in the economy. Perhaps at this moment the man thought this was the future of this activity.

As everybody knows the world has changed and will continue changing very rapidly. One hundred years ago the entrepreneur was the farmer or grower; during the last century it became the manufacturer, and in the new century it is the idea maker who is changing the world.

Entrepreneurs such as Walt Disney, Richard Branson, and Howard Shultz, among others, have changed the way things are done in their respective industries; none of them saw the opportunities in horticulture. If they had, would they have done things differently?

None of these personalities are with us for this presentation; all we can offer is conjecture on how they would have developed the propagation industry.

One way to achieve these ideas and knowledge, and to make it a reality, is by being a part of established associations, first at the local level and from them to national and international status. By doing this, our International Plant Propagators' Society was formed.

### HISTORY

The International Plant Propagators' Society (I.P.P.S.) is a select group of plant propagators now organized internationally. An original group of approximately 70 propagators met in Cleveland, Ohio (U.S.A.) in November 1951 to form our Society, which has now grown to more than 2400 individual members, affiliated in one of eight regional organizations.

The main reason for the International Plant Propagators' Society is to promote, search, and share information about the art and science of plant propagation. The organization structure is in regions, based on plant interest and groupings of similar climate zones, rather than on political or state boundaries. Actually, our Society has eight regions: Australia; New Zealand; IPPS Japan; Scandinavia; The Region of Great Britain and Ireland; and three in the U.S.A: Eastern Region, North America (includes eastern part of Canada), Southern Region of North America., and Western Region (includes western part of Canada; with one Potential Region in Southern Africa (The Southern African Potential Region).

Each region is self-governing with a President, two or more Vice-Presidents, Secretary/Treasurer, Editor, Historian, committee members with direct responsibilities, and an International Director who represents the region on the International Board.

I.P.P.S. has a strong recruitment policy of expansion with objectives to recruit members from other areas of the world and to create new regions where they do not yet exist. It offers members access to a wealth of experience and knowledge.



## MOTTO

The motto of our Society is “To Seek and To Share.” This motto makes our society both unique and beneficial. Members are expected to seek and share information with one another by attending meetings and taking the opportunity to talk with the experts in propagation and place articles in I.P.P.S. publications. These have been the strengths of I.P.P.S. as it enters its 5th decade.

Although the Eastern Region, North America attracts members from all over the world, most of its members are from an area spanning the U.S.A. states from North Dakota to Colorado in the west to the East Coast, and from the provinces of Canada in the north to the border between Pennsylvania and Maryland in the Mid-Atlantic Region to Missouri.

The membership is comprised of propagators from small family businesses as well as huge nursery and greenhouse operations. Educators and researchers at universities and botanic gardens and arboreta are represented as well. The Region is strengthened by the diversity of its membership. Members are strongly encouraged to become actively involved in the Society through the presentation of papers or posters, committee membership, and service on the Board of Directors.

## BENEFITS

Membership in the I.P.P.S. Eastern Region brings many benefits:

- Option 1 members receive a copy of the *Combined Proceedings International Plant Propagators' Society*, a hardback bound book or CD of more than 600 pages that includes all the papers presented at the Regional conferences around the world. The Proceedings include articles on plant propagation techniques old and new, plant introductions, integrated pest management, specialty plant production, growing media, and much more.
- Members have access to an online membership database directory. This valuable resource lists detailed information about each I.P.P.S. member worldwide.
- In addition, Eastern Region, North America members receive three issues annually of the *North American Plant Propagator* newsletter. This newsletter details the activities of the three North American Regions and presents recent research in plant propagation as well as current Regional activities and news.
- Members may also attend the Annual Meeting at a discounted rate.
- Membership in the Eastern Region, North America provides a wealth of practical educational and technical information as well as fostering long-lasting friendship among those dedicated to its ideals.

To finish this presentation I want to thank to the International Plant Propagators' Society Eastern Region Committee for this opportunity to participate in this conference, especially to Steve Castorani, Vice-President Eastern Region, North America, who spent lots of his time to make this conference a success and include Spanish-language sessions. As a Human Resources Manager at Princeton Nurseries in Allentown, New Jersey, and as a member of the Horticultural Advisory Committee at Mercer County Community College, I will do everything possible to put in practice the knowledge learned in this conference. Princeton Nurseries has their doors open to anyone at any time who wants to continue with our motto “to seek and share.”

## From Propagation to Finish: Container Production at Princeton Nurseries®

**Baldomero Aparicio**

Princeton Nurseries, Inc., P.O. Box 185, Allentown, New Jersey 08501 U.S.A.

### INTRODUCTION

Princeton Nurseries enjoys a rich legacy of improved plant introductions. The nursery introduced some of the most celebrated trees in American horticulture. The seedling program at Princeton Nurseries is the first step on a plant journey to our high-density container and specimen fields. William Flemer III made many of his famous selections in our seedbeds. To name a few: *Ulmus americana* 'Princeton', *Gleditsia triacanthos* var. *inermis* 'Shademaster', *Acer rubrum* 'October Glory', *Tilia cordata* 'Greenspire', *Zelkova serrata* 'Green Vase', and Princeton Nurseries latest introduction, *Acer tataricum* subsp. *ginnala* 'Ruby Slippers'. In the future, it is important to carry on this tradition of excellence.

The propagation department at Princeton Nurseries is responsible for all cuttings propagated, bare-root grafts, potted grafts, and tissue culture transplants.

### SEEDLING PRODUCTION

All seedling production occurs at the Thread Farm. Seventy acres of this farm are used for production. Fifteen acres is used yearly, and the remainder is on a 4-year rotation so the land can be rested between crops. All seed beds are treated with methyl bromide prior to planting to control weed germination and pathogens. Each year approximately 1,400,000 seedlings are produced. Princeton Nurseries uses 30% of the total seedling production, and 70% is used for our selected seedling sales.

The seed is hand-sown to give proper spacing so that all seedlings develop a proper balance between root mass and the plant. All sources are from local or compatible zone-hardy regions, and most of this seed is from our own stock plants. Almost all of the seedlings are harvested in the early spring. The harvested seedlings are then individually graded by caliper and quality. Currently the propagation department is propagating over 50 different genera of seedlings.

### GRAFTS, CUTTINGS, AND TISSUE CULTURE PROPAGATION

The propagation department at Princeton Nurseries is presently propagating over 40 different genera from cuttings, grafts, and tissue culture. Eighty-five percent of all cuttings and scion wood used by the propagation department comes from our own stock blocks, which are at several locations throughout the nursery. Several outside sources produce all tissue culture plants. Under the current production plan, this department is producing 100,000 plants from cuttings, 25,000 plants from tissue culture, 10,000 potted grafts, and 50,000 bare-root grafts.

Asexually propagated material is housed in six 28 ft × 96 ft Jaderloon greenhouses and a 60 ft × 96 ft Cravo retractable-sides-and-roof greenhouse. Several of these houses are equipped with heated floors.

## CONTAINER DEPARTMENT

At Princeton Nurseries we produce three product lines in containers, Prince Trees<sup>®</sup>, Prince Shrubs<sup>™</sup>, and Princess Perennials<sup>™</sup>.

**Prince Shrubs.** Container department produces 115,000 Prince Shrubs in 75 18 ft × 200 ft hoop houses that give us a total of 6 acres of growing bed area. The container department receives small liners from the propagation department. We decide in what size container the plant will be potted according to the final product that will go to the customer; this decision is made based on the growing habit of each plant type. Regularly we use #1 and #2 containers, but nothing bigger than these, to save space and to get a uniform top of the plant and an ideal root mass. We add a slow-release fertilizer to the potting mix: Osmocote Pro 20-4-8. Our potting mix is 9 composted pine bark : 1 sand (v/v) and is pH amended to 5.8 with lime. On this phase, our containers are not spaced but we keep them under control by pruning when necessary and monitoring the roots to avoid problems in the future. To avoid diseases, we watch irrigation closely during the growing season, adjusting it according to individual necessities and weather requirements.

Shade cloth is part of our infrastructure to provide relief to our plants in the hot days of summer, so the plants can reach their maximum growing potential in a short period of time.

Around September our plants are reaching the shape and roots that we are looking for, so we get ready to start the 2nd phase of our production. We shift up our liners to bigger containers, #2, #3, and #5, which constitute the majority of our Prince Shrubs production. Since the roots will be exposed, we pay especial attention to avoid a root-bound condition in the future.

All our shrubs are placed in the houses pot to pot for the winter. In each house we leave a walkway down the center to monitor the pots daily through the winter. Each house will hold about 3,100 shrubs on average. We try to group our plant material by water and light requirements as well as cold hardiness. The more cold hardy plant material will be covered with 50% opacity 5-mil polyfilm. The slightly more sensitive plants, or plants we like to get started early in the spring, are covered using 35% opacity 5-mil polyfilm. Every house has a large hinged door on each end for easy access and ventilation.

The transition between end of the winter and beginning of spring will bring us a challenge; to keep our plants in the perfect conditions we must decide when to uncover our houses. If we take the plastic off the houses too early, the more sensitive plants can suffer damage due to variations in the weather, but if we wait too long, plants can start growing ahead of time, which can cause problems too.

Our shrubs are spaced approximately 2 ft × 2 ft to offer them the necessary space so they can grow freely; at the same time this will facilitate the process of fertilization and pruning. We apply a pre-emergent herbicide and top-dress them one more time before they start growing. Pruning is an important practice in Princeton Nurseries culture; it is done by hand and as many times as necessary to get the desired shape on each plant type. We use an overhead irrigation system with Nelson spinners.

**Prince Trees.** Our propagation department supplies all the understock and seedlings, which are lined out in high-density fields. This material is planted in April and May, depending on ground conditions. All high-density fields are planted with 44-ft-wide sections to accommodate spray equipment. Row length will vary to ac-

commodate crew access and ease of maintenance. All plantings are grouped according to soil conditions, genus requirements, similarity of spraying requirements, and cultural practices. Care and development after planting varies greatly depending on plant type, rate of growth, and harvest size.

The in-ground cycle can vary from 1 to 4 years, depending on growth rate. In the final fall of the in-ground cycle, the trees will be evaluated and allocated to our container division. The trees are harvested and field sorted by grade and by the division to which the product is allocated. The product is immediately sent to our 1-acre storage facility for a final inspection and grading. It is then stored at 38 °F refrigeration and 95% humidity until planting.

While the trees are in this building our crews start the very delicate process of grading and getting only the ones that fit the standard to become a Prince Tree. Our own developed trimming system will vary according to plant type, but the objective will be the same: to provide the customer with a larger, canopy size tree. At the same time we carefully trim the roots to fit into the containers. We pot approximately 20,000 Prince Trees in early spring. We use a soil conveyor with a special end that will reduce spilling and increase production developed by our container department. Potting depth is critical, so our crews pay special attention so the tree will stay in the center of the container. Like our Prince Shrubs, fertilizer is incorporated into the potting mix. We pot around 1500 #20 can trees a day.

***Trellis System.*** Our trellis system for growing Prince Trees was created in 1996 during a very windy growing season. We needed a system to hold the trees in place and stop them from blowing over. We were unable to use a pot-in-pot growing system due to the limitation of heavy soil conditions. A steel cord is fastened between two poles and stretched over a 25 ft area. Along the cord are approximately six padded clips, which fasten the trunk of the tree to the trellis and holds the tree securely in place. This arrangement not only saves labor and decreases damage to the trees, but also provides an opportunity for early root development for better plant growth.

All trees are pruned once or twice a year, with the timing of the pruning being dependent on the growth habit of the plants. Our irrigation system is a 150-hp turbine pump, which provides water to our yard. A chlorination and filtration system has been installed to maintain the quality for the drip irrigation. All systems are radio-signal controlled.

In September, when our product is finished and ready to be ship, we use a shipping system also developed by our department that consists of a cardboard cover that fits the top of the container to hold the soil in its place. A triangular cardboard tube will be attached to the trunk to avoid any damage to the bark and make our trees more presentable.

***Cravo Building.*** Trees are specially challenging to overwinter simply because of their height. The Cravo building is 18 ft tall at its gutters, which accommodates even our largest #20 gal trees. Prior to the construction of the Cravo building the trees were laid down and covered with a poly tunnel for the winter. This did not allow access to the plants to check for disease, rodent damage, or moisture. It also caused many flowering plant taxa to break bud early on warm winter days. The Cravo building has eliminated all these problems. With a retractable roof and retractable side curtains, we are able to vent the building as well as close it to main-

tain heat. The roof is also left open in the event of snow. Snow on and around the containers helps to insulate the pots and supplies a slow, steady source of moisture. If the containers become too wet, we simply leave the roof closed the next time it rains. If the trees become dry and there is no precipitation in sight, we can irrigate using our frost-free system.

With the high competitive level in the horticultural industry, Princeton Nurseries keeps the legacy of improved plant material at a high level. To get to this standard of excellence, the company makes sure to use the right methods and techniques and at the same time makes an effort to keep the human touch between employees so you, the customer, receive a quality product that follows industry guidelines and makes us really proud.

---

## Propagating *Asclepias tuberosa* from Seed: The Process®

### Francisco Castillo

Midwest Groundcovers: St. Charles, Illinois 60174 U.S.A.

### INTRODUCTION

Midwest Groundcovers is a wholesale nursery specializing in the production of groundcovers, ornamental shrubbery, perennials, and natives. A large portion of our perennial stock is propagated through division and softwood cuttings, but others, which cannot be produced in this method, rely on seeds to propagate. *Asclepias tuberosa* is one of those unique plants that is difficult to propagate vegetatively from cuttings but has a high percentage when using seed. In the past we used to buy in divisions, but quickly found that we would lose more than 50% of the crop within 2 to 3 weeks of planting. It was soon decided that an alternative method was needed to produce this plant. Seed propagation seemed the most logical step to take so we began by trialing this technique by directly seeding into 1-gal containers. Immediately we saw great success with 100% of the crop surviving and flourishing. We understand that planting *Asclepias* in this method doesn't produce a large quantity of blooms until the second season, but with careful production timing, anyone can have a beautiful crop in a limited amount of time.

### PROPAGATION METHODS

The following describes our propagation system for producing *A. tuberosa* from seed.

**Seed Propagation.** At Midwest Groundcovers we buy in thousands of *Asclepias* seeds in late fall. Buying at this time guarantees that you will receive fresh seed from the corresponding summer crop. There is no seed treatment necessary for this crop, so it is put into cold storage at 36 °F until the following spring. The seeds are then planted in the middle of April to ensure a successful crop that can be sold that fall (Figs. 1 to 7). With this method, a 1/2-inch hole is dug, filled with twenty to 25 seeds, and covered with vermiculite. This will ensure the seed stays moist while allowing light to penetrate the substrate and therefore allowing the seed to germinate. The plant is immediately covered with 30% shade cloth for 3 to 4 weeks and is misted every hour until germination. After the 3 to 4 weeks of shade cloth, the

tain heat. The roof is also left open in the event of snow. Snow on and around the containers helps to insulate the pots and supplies a slow, steady source of moisture. If the containers become too wet, we simply leave the roof closed the next time it rains. If the trees become dry and there is no precipitation in sight, we can irrigate using our frost-free system.

With the high competitive level in the horticultural industry, Princeton Nurseries keeps the legacy of improved plant material at a high level. To get to this standard of excellence, the company makes sure to use the right methods and techniques and at the same time makes an effort to keep the human touch between employees so you, the customer, receive a quality product that follows industry guidelines and makes us really proud.

---

## Propagating *Asclepias tuberosa* from Seed: The Process®

### Francisco Castillo

Midwest Groundcovers: St. Charles, Illinois 60174 U.S.A.

### INTRODUCTION

Midwest Groundcovers is a wholesale nursery specializing in the production of groundcovers, ornamental shrubbery, perennials, and natives. A large portion of our perennial stock is propagated through division and softwood cuttings, but others, which cannot be produced in this method, rely on seeds to propagate. *Asclepias tuberosa* is one of those unique plants that is difficult to propagate vegetatively from cuttings but has a high percentage when using seed. In the past we used to buy in divisions, but quickly found that we would lose more than 50% of the crop within 2 to 3 weeks of planting. It was soon decided that an alternative method was needed to produce this plant. Seed propagation seemed the most logical step to take so we began by trialing this technique by directly seeding into 1-gal containers. Immediately we saw great success with 100% of the crop surviving and flourishing. We understand that planting *Asclepias* in this method doesn't produce a large quantity of blooms until the second season, but with careful production timing, anyone can have a beautiful crop in a limited amount of time.

### PROPAGATION METHODS

The following describes our propagation system for producing *A. tuberosa* from seed.

**Seed Propagation.** At Midwest Groundcovers we buy in thousands of *Asclepias* seeds in late fall. Buying at this time guarantees that you will receive fresh seed from the corresponding summer crop. There is no seed treatment necessary for this crop, so it is put into cold storage at 36 °F until the following spring. The seeds are then planted in the middle of April to ensure a successful crop that can be sold that fall (Figs. 1 to 7). With this method, a 1/2-inch hole is dug, filled with twenty to 25 seeds, and covered with vermiculite. This will ensure the seed stays moist while allowing light to penetrate the substrate and therefore allowing the seed to germinate. The plant is immediately covered with 30% shade cloth for 3 to 4 weeks and is misted every hour until germination. After the 3 to 4 weeks of shade cloth, the



Figure 1. *Asclepias tuberosa* seed.



Figure 2. Planting seed of *Asclepias tuberosa*.





**Figure 3.** Quantity of seed per container is 20 to 30 seeds.



**Figure 4.** Seed covered with vermiculite.



Figure 5. *Asclepias tuberosa* 3 months later.



Figure 6. *Asclepias tuberosa* 3 months later in a 1-gal container.



**Figure 7.** *Asclepias tuberosa* 1 year later in a 1-gal container.

plant is put into full sun and is drenched with systemic fungicides to discourage any crown rotting. The plant is put on a strict continuous fertilizer regime after about 8 weeks and is kept on this program until sold.

## **CONCLUSION**

At Midwest Groundcovers we pride ourselves on being very successful growers and propagators. With *A. tuberosa*, we were given the challenge of finding a cheap way to produce a plant that historically has been difficult to propagate. By utilizing seed to manufacture this crop, we have dramatically cut costs while reducing labor and gaining a much more successful percentage. Seeding is the most efficient and effective way of producing this plant and has proven itself through years of seed propagation.

## Nutrition and Management of Perennial Stock Plants®

**Sinclair A. Adam, Jr.**

Ambler College, Landscape Architecture and Horticulture Department & The Center for Sustainable Communities, Temple University, Ambler, Pennsylvania 19002 U.S.A.

### INTRODUCTION

Nutritional management is an area of concern for producers of horticultural products due to basic production requirements and environmental impact. With an increased public focus on environmental issues, fertility inputs should be carefully regulated. Nitrogen is an element used widely in horticulture and can be applied in considerable amounts both in horticulture and agriculture (Mengel and Kirkby, 2001). The federal limit for nitrate levels in water is  $10 \text{ mg}\cdot\text{L}^{-1}$  (10 ppm N), and nitrogen is a non-point-source type of pollution that is impacting water quality in the U.S.A. (Fenn, et al., 1998; Gustafson and Wang, 2002). A growing number of states have laws regulating run-off (and leached materials) from agricultural and horticultural operations, and states that don't yet have laws regarding containment of plant nutrients probably will have them soon (Lea-Cox and Ross, 2001; Lea-Cox, 2001). From typical perennials fed at 136 ppm N, leachate can contain 1 to 96  $\text{mg}\cdot\text{L}^{-1}$  nitrate (Adam and Sluzis, 2005). According to recently published research, 0.5%–15% of the container leachate could be running off propex-covered growing areas, with the remainder sinking into subtending base materials or soil (Million et al., 2005). Growers and propagators have an interest in the careful management for the compliance with laws that are intended to benefit the environment, and a number of growers are demonstrating leadership in their communities with serious dedication of their time and monies to environmental enhancement projects.

Proper management and efficiency in the production of plants results in high yields. Stock plant culture is typically an area of production where efficiency and management are of particular importance, and to attain consistently high yields, plant production should be optimized. To optimize the production of stock, proper nutritional information is critical. While herbaceous perennial plants continue to increase in demand, the nutrient requirements of these perennial plants are not well documented (Dubois et al., 2000; Perry and Adam Jr. 1990; Rowe and Cregg, 2002). Some research has been published recently, but more work is required to significantly cover this important topic in production and propagation (Dubois et al., 2000; Kraus et al., 2002). Growers and propagators benefit from careful management of nutrient inputs by efficiency gains in operations, quality gains in product, and enhanced environmental quality.

### BACKGROUND

Stock plant management can be influenced by the lifecycle of the stock plant, the stock plant culture, the environmental conditions the plant is subjected to, and the source material. Nutritional management will involve the quantity of nutrients, the quality of nutrients (how they are proportioned and formulated), and the influences of water pH and water quality. Stock plant nutritional management is one of the variables in production under direct control by the grower, and the successful management of the fertility situation (and the stock environment) will yield the cor-

rect C : N ratio for the cutting material to be harvested. Cuttings with the proper C : N ratios will have optimal growth and development when placed in the proper environment for rooting (Hartmann et al., 2002).

Herbaceous perennials as a commodity group is challenging in the respect that there are a considerable number of genera, species, cultivars, and selections that are grown, with more arriving every season. Many perennials are undocumented in their nutritional requirements and environmental responses (when compared to the annual and bedding plants, greenhouse foliage and flowering products, and woody trees and shrubs).

Stock plants typically have a lifespan and yield potential that are determined by the variables that propagators manage, including nutrition (Fig. 1). Proper nutrition will extend the lifespan of the stock plant but not beyond what is typical for that cultivar or management strategy (such as plant spacing or pot diameter). Growers planting new stock typically start with divisions, seedlings, or rooted cuttings, and these are potted up into larger sizes. These stock plants may be potted directly into 1-gal pots or larger or could be potted into an intermediate size prior to their final productive size. Cutting yields may be harvested in a few days to a week after potting (Hartmann et al., 2002). When starting with an unpinched, single-shoot liner, the yield of cuttings typically doubles for most perennials until the plant canopy has become full. When the plant has attained a full canopy for the container size and spacing, the cutting yield seems to level off due to shoot crowding, light inception, and plant-to-plant crowding. Many perennials will initiate new shoots from the crown as the stock ages and also lose productivity of stems that have been repeatedly cut and become mature. The attrition of older stems, balanced with the production of new shoots if well managed, will result in a leveling off of the yield curve and a plateau effect of the number of cuttings harvested. The length of the plateau is influenced by culture (Fig. 2).

When the plateau begins to taper off and yields drop, it is time to replace the stock. Eventually the plants will become too pot-bound to maintain proper (plant) water requirements or may succumb to the cumulative effects of insects and disease problems. The uniformity of cuttings harvested decreases with increasing stock age and plant vigor problems. Each perennial taxon will have its own curve and plateau length, although there will be similarities within groups (Fig. 3). *Geranium* × *cantabrigiense* selections and hybrids are very close in performance ('Biokovo', 'Berggarten', and 'St. Ola'). Many *Phlox paniculata* hybrids and selections are also quite similar in yields and longevity. The yield and duration of productive yield can also be regulated by management objective, as in the case of mum production where stock plants yield cuttings on a one-time harvest basis.

Nutritional requirements of herbaceous perennials vary, and each species or cultivar should be grown at the optimum nutritional level (Fig. 4). Nitrogen research conducted at Temple in 2002 from the testing of 10 species of perennials indicated that nitrogen levels greater than 136 ppm N (applied every other irrigation) were not significant in terms of whole plant growth. Plants were typically averaging 2%–3% tissue nitrogen percent in this experiment (at 136 ppm N), but some species tested indicated an ability to act in environmental applications by taking up to as much as 5% tissue N. Leachates increased with increasing treatment level in 2002, and nitrates at the upper treatment levels were typically well above the federal limit of 10 mg·L<sup>-1</sup>.



The variability of perennial species grown in industry, the list of the species suggested for Pennsylvania and New Jersey state Department of Environmental Protection planting recommendations for environmental projects, and the Perennial Plant Associations's generosity led to the research of an additional 10 species in 2003. *Symphyotrichum* (syn. *Aster*) *novae-angliae* 'Purple Dome', *Chelone lyonii*, *Coreopsis verticillata* 'Moonbeam', *Dryopteris intermedia*, *Heliopsis helianthoides*, *Monarda* 'Marshall's Delight', *Penstemon digitalis* 'Husker's Red', *Phlox glaberrima* 'Morris Berd', *Polemonium reptans*, and *Zizia aurea* were submitted to the same methods used in the 2002 study. Similar results occurred, in that no growth benefits of significance occurred above the 136 ppm treatment level (averaging 2%–3.2% tissue N) as with 2002. Some species (*S. novae-angliae* 'Purple Dome' and *H. helianthoides*) demonstrated an excellent potential as plants for environmental use in nitrogen removal from ground and surface water by attaining tissue levels above 4% N.

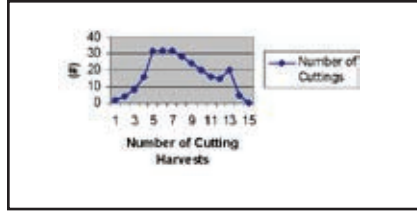


Figure 1. Cutting yield of *Phlox paniculata*.

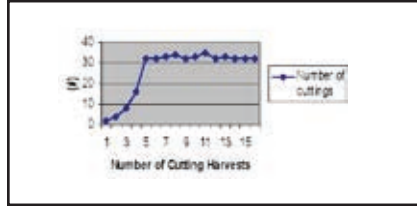


Figure 2. Cutting yield of *Phlox paniculata*.

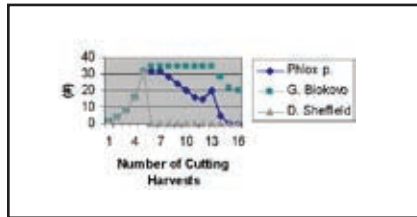


Figure 3. Cutting yield of *Phlox paniculata*, *Geranium*  $\times$  *cantabrigiense* 'Biokovo', and *Den-dranthema* 'Sheffield'.

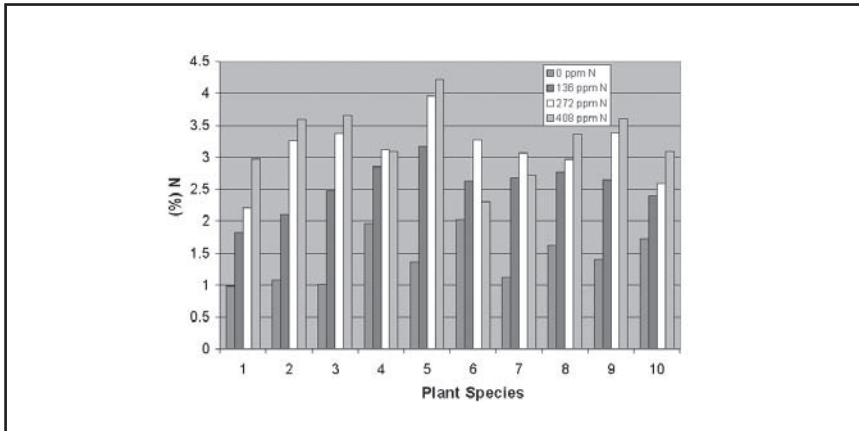


Figure 4. Tissue nitrogen levels of 10 herbaceous perennials (1 = *Eupatorium purpureum* subsp. *maculatum*, 2 = *Hibiscus moscheutos*, 3 = *Lobelia cardinalis*, 4 = *Phlox paniculata*, 5 = *Rudbeckia fulgida*, 6 = *Solidago caesia*, 7 = *Osmunda claytoniana*, 8 = *Dryopteris marginalis*, 9 = *Eupatorium coelestinum*, 10 = *Tiarella cordifolia*).

Nursery experimentation with *Heuchera* 'Snow Angel' has indicated a similar trend to Temple-based research, in that a 125–130 ppm N range (using Peters Peat Lite Special 15–16–17) works best for weekly feed, versus 80–90 ppm N for constant feed (2002–2003). *Heuchera* 'Snow Angel' takes 4 to 6 weeks for cutting development on stock plants, and takes slightly longer than the typical 2 to 4 weeks to root into a 70-unit flat.

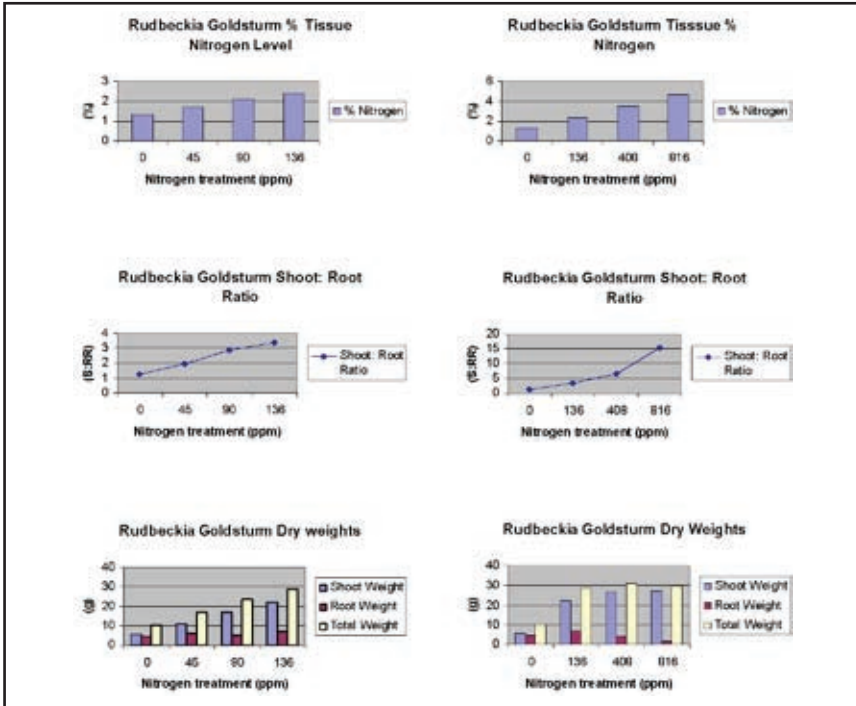
Nutritional rates should also be adjusted for environmental changes and plant growth cycle phases. Growth of perennials in the low-light months will be reduced, and feed should be correspondingly reduced by  $\frac{1}{2}$  to  $\frac{2}{3}$  for most plants and eliminated for plants in dormancy. Greenhouse growth of *Sedum makinoi* 'Ogon' (in September and October) progresses steadily showing a significant increase in plant material and plant canopy increase. With further reductions in light and day length, however, growth will slow, and reductions in fertility should be implemented. By November *S. makinoi* 'Ogon' slowed in growth considerably and produced comparatively little harvestable material for cutting relative to the amount available in the September–October period.

Nutritional management for high yields as well as low environmental impact should be theoretically based and locally enforced. Each individual operation has unique water, media, temperature, light, air circulation, and management conditions. Local enforcement simply stated is taking the set of conditions that exist and choosing the best fertility plan to meet the plant requirement and those circumstances. The choice of using soil incorporated, soil surface applied, liquid applied, or a combination of fertilizer application methods is therefore relative to the individual operation and its production methods. The level established by the 2002–2003 work provides a good guideline as to N rate for the 20 species tested, but questions such as preferred N form, N form ratio, sustainable levels of N fertilization, and N-level cycling remained. So too did the question as to what the upper end of N tolerance was for the species tested in 2002–2003 that showed potential for environmental applications.

## METHODS 2004

The five species of herbaceous perennial plants that demonstrated the greatest tissue levels of nitrogen in 2002–2003 were subjected to two experiments in 2004. *Symphytotrichum novae-angliae* 'Purple Dome', *H. helianthoides*, *M.* 'Marshall's Delight', *P. reptans*, and *Rudbeckia fulgida* var. *sullivantii* 'Goldsturm' were potted into 15.24 cm (6 in. std.) containers filled with Sunshine Mix #2 (Sungro Inc., Bellview, Washington). Sunshine mix #2 is a peat-based potting medium with no nutrient starter charge and only dolomitic limestone added. In the first experiment, the five perennial plant selections were placed in the Temple University Ambler greenhouses in a complete randomized block design with seven replicates. Nitrogen treatment levels were set at 0, 45.33, 90.66, and 135.99 ppm N applied as  $\text{NH}_4\text{NO}_3$ . Potassium was supplied at 79 ppm K, as KCl, and micronutrients as S.T.E.M. (Scotts-Sierra Co., Marysville, Ohio) in a one-time treatment at the beginning of the experimental period. Super phosphate (0-45-0) was incorporated at the rate of  $1.3 \text{ kg}\cdot\text{m}^{-3}$  of medium. Nitrogen and potassium were applied by hand every other irrigation (up to three times per week) with a nutrient solution providing the ammonium nitrate and potassium chloride and irrigation volume was 400 ml per pot (which provided a 10% leached fraction). Container leachate and pH were monitored throughout the experimental period, and leachate was analyzed for nitrogen content (Cedar

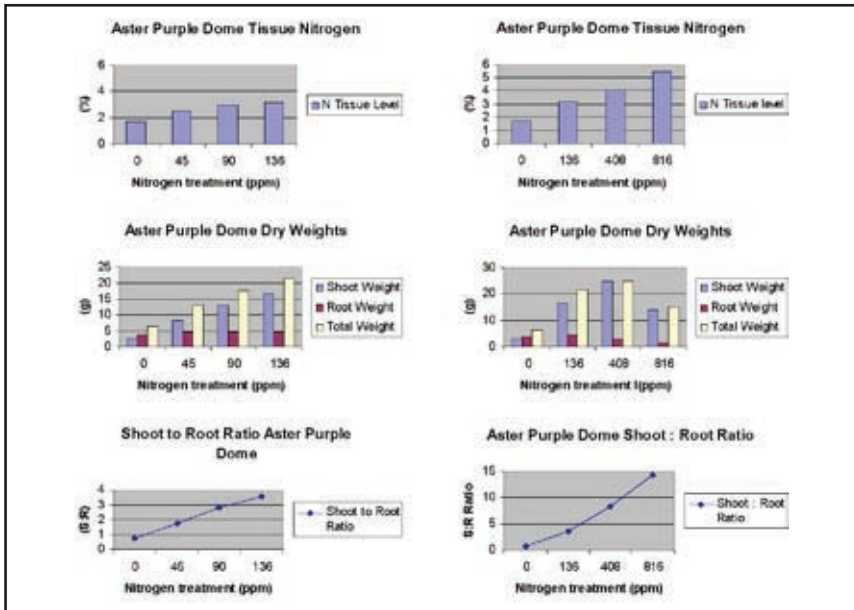




**Figure 5.** *Rudbeckia fulgida* var. *sullivantii* 'Goldsturm' tissue nitrogen levels, dry weights, and shoot to root ratios.

Grove Laboratories Downingtown, Pennsylvania). Light level was measured with a LI-Cor LI 250 light meter and a LI-190SA quantum sensor (LI-Cor Biosciences Lincoln, Nebraska), and greenhouse temperatures were monitored and recorded. Plant grade (a subjective salability rating) from 0–5 (0 being dead and 5 denoting exceptional size and depth of green foliage color) was recorded on a monthly basis, as were plant height, width, growth index (height + width + width)/3, and chlorophyll level (SPAD 502 Minolta), and representative digital images were created. At the end of the experimental period (90 days), the roots were washed free of the substrate, and each plant was separated into roots and shoots. Fresh and dry weights were measured for shoots and roots. Plant shoot tissue was analyzed for nitrogen, phosphorus, potassium, calcium, magnesium, sulfur, boron, copper, iron, manganese, zinc, and sodium (Spectrum Technologies Washington Courthouse, Ohio). Data were analyzed by analysis of variance and regression where applicable. Variables were transformed where necessary to satisfy normality and homogeneity of variance.

A second experiment was set up in the Temple University greenhouses that evaluated the upper end of the nitrogen level tests. This was identical to the first in all respects except the nitrogen treatment levels. Levels in the second experiment were 0, 136, 408, 816 ppm N applied as  $\text{NH}_4\text{NO}_3$ .



**Figure 6.** *Symphytichum novae-angliae* 'Purple Dome' tissue nitrogen levels, dry weights, and shoot to root ratios.

## RESULTS 2004 EXPERIMENTS

In both experiments, *S. novae-angliae* 'Purple Dome', and *R. fulgida* var. *sullivantii* 'Goldsturm' showed similar trends in nitrogen uptake and growth. In the first experiment tissue levels of chlorophyll (SPAD) increased with increasing treatment, as did weight gains and size measurements.

For *R. fulgida* var. *sullivantii* 'Goldsturm', plant weights were greatest at the 136 ppm N treatment, plant height, width, growth index, and percent tissue N all indicated no significant differences above the 90 ppm N level, and chlorophyll (SPAD) measures that numerically increased with increasing N treatment level was not significant above the 45 ppm N treatment level (Fig. 5). Shoot to root (S : R) ratios were above 1 at the control treatment level and were not significantly different from each other above the 90 ppm N treatment level. In the second experiment root injury was observed at the 816 ppm treatment level, and the shoot to root ratio was 15.22, which was significantly different from all the lower treatment levels. Chlorophyll level and tissue N significantly increased with increasing treatment levels exhibiting similar results to the S : R ratio. As in the 2002–2003 studies, there was no significant difference in weight, plant dimensions, or growth index above 136 ppm N treatment level.

*Symphytichum novae-angliae* 'Purple Dome' also exhibited significant weight gains at all treatment levels in the first experiment (0, 45, 90, 136 ppm N) (Fig. 6). Growth index, width, and percent tissue N were not significantly different above the 90 ppm N treatment level. Plant grade and chlorophyll level (SPAD) were not significantly different above the 45 ppm N treatment level. In the second experiment, plant weights exhibited no significant differences above 136 ppm N treat-

ment for root and total plant dry weight. Shoot weight was greatest at the 408 ppm N treatment level. Plant grade height, width, and growth index all showed no significant differences with higher treatment levels than 136 ppm N, which was also the case with chlorophyll (SPAD) measurements.

## CONCLUSIONS

Optimum growth occurred for *R. fulgida* var. *sullivantii* 'Goldsturm', and *S. no-vae-angliae* 'Purple Dome' at 136 ppm N, but sustainable growth occurred at 90 ppm N for both perennials. Plants at this treatment level produced a 2.86 and 2.83 S : R ratio for *Rudbeckia* and *Symphytotrichum*, respectively, which corresponded with a range of 2%–3% tissue N. Established plants grown at the 90 ppm nitrogen treatment level would provide sufficient cutting material for suitable harvests in propagation.

As stock plants mature over their productive life cycle, root systems develop in the containers and the percent of the plant weight harvested in the normal propagation cycle diminishes compared to the total plant weight. This trend would result in a diminished removal of total plant nutrients through the harvesting of the cuttings from the stock plant. The percent of added nutrition for stock plant growth (compared with container plant production for sale) should be equal to the sustainable rate plus the nutrients removed by harvesting the cuttings. For *Rudbeckia* and *Symphytotrichum*, the harvested percent of nutrients would be estimated to range from 1%–10% of the plant weight. The 1%–10% rate, when added to the sustainable N production level, should maintain the S : R ratio of 2.85, an ample amount of shoot production for harvest. However, this is an estimate based on the results of our research, and further experimentation should be undertaken to test the inference.

Perennials grown for stock plants can be cultivated at 60–150 ppm N. Many species, cultivars, and hybrids of perennials can probably be grown at lower N levels than expected, and advantages could be obtained by reduction of the nutrient levels prior to harvesting cuttings. For species that have been tested in the 2002–2004 period, the following nitrogen fertility strategy is recommended for stock plant culture: 125–100 ppm N for the early phase of growth, followed by 80–90 ppm N, and then 50–75 ppm N just prior to harvest of cuttings. This strategy would reduce the nutrient impact for three out of the four intervals (or weeks) in the production cycle, without compromising cutting yield or stock plant quality.

More research is required for completion of the perennial production and propagation picture. Cutting yield should be documented and tested against nutritional inputs directly. Other nutrient elements should be investigated in their role in perennial stock management and cutting yields as well. Then too, many perennials remain, yet to be investigated in their nutritional needs and growth.

## LITERATURE CITED

- Adam, S.A., and E.A. Sluzis. 2005. The nitrogen nutrition of 10 native perennial species. *Perennial Plant Association Journal* Fall 2005:34–45.
- Dubois, J.B., S.L. Warren, and F.A. Blazich. 2000. Nitrogen nutrition of containerized *Anemone × hybrida*. *J. Environ. Hort.* 18:145–148.
- Fenn, M.E., M.A. Poth, J.D. Aber, J.S. Baron, B.T. Bormann, D.W. Johnson, A.D. Lemly, S.G. McNulty, D.F. Ryan, and R. Stottlemeyer. 1998. Nitrogen excess in North American ecosystems: Predisposing factors, ecosystem responses, and management strategies. *Ecol. Applications* 8(3):706–733.
- Gustafson, S., and S.D. Wang. 2002. Effects of agricultural runoff on vegetation composition

- of a priority conservation wetland, Vermont, U.S. J. Environ. Qual. 31:350–357.
- Hartmann, H.T., D.E. Kester, F.T. Davies, Jr., and R.L. Geneve.** 2002. Plant propagation: Principals and practices. 7th ed. Prentice Hall Inc., Englewood Cliffs, New Jersey.
- Kraus, H.T., S.L. Warren, and C.E. Anderson.** 2002. Nitrogen form affects growth, mineral nutrient content, and root anatomy of *Cotoneaster* and *Rudbeckia*. HortScience 37:126–129.
- Lea-Cox, J.D., and D.S. Ross.** 2001. A review of the Federal Clean Water Act and the Maryland Water Quality Improvement Act: The rationale for developing a water and nutrient management planning process for container nursery and greenhouse operations. J. Environ. Hort. 19:226–229.
- Lea-Cox, J.D., D.S. Ross, and K.M. Tefteau.** 2001. A water and nutrient management planning process for container nursery and greenhouse production systems in Maryland. J. Environ. Hort. 19:230–236.
- Mengel, K., and E.A. Kirkby.** 2001. Principals of plant nutrition. Kulwer Academic Pub. Dordrecht, the Netherlands.
- Million, J., T. Yeager, H. Bryant, C. Larsen, J. Shook, and J. Albaro.** 2005. Effects of slope and underlay on surface runoff of irrigation from woven polypropylene ground-cloth. HorTech. 154:772–776.
- Perry, L.P., and S.A. Adam Jr.** 1990. Nitrogen nutrition of container grown *Hemerocallis* × '*Stella de Oro*'. J. Environ. Hort. 8:19–21.
- Rowe, D.B., and B.M. Cregg.** 2002. Effects of incorporating controlled-release fertilizer on adventitious rooting and growth of *Artemisia*, *Gaura*, and *Nepeta*. J. Environ. Hort. 20:1–6.

---

## Germination of *Rudbeckia fulgida* var. *sullivantii* 'Goldsturm'<sup>®</sup>

**Allen R. Pyle**

C. Raker & Sons, Inc., 10371 Rainey Rd., Litchfield, Michigan 49252 U.S.A.

### INTRODUCTION

*Rudbeckia fulgida* var. *sullivantii* 'Goldsturm' is a popular, award-winning perennial. It has consistently remained a top-three-selling perennial at Raker over the last 10 years. Raker annually produces in excess of 2 million 'Goldsturm' plugs from seed.

Like many perennials, consistent success with germinating *Rudbeckia* 'Goldsturm' is challenging, as germination and seed vigor can vary significantly from seed lot to seed lot, regardless of supplier. In our experience, 'Goldsturm' germination typically ranges from 20%–80% for standard lots.

### ENHANCED SEED

There are now multiple suppliers offering enhanced 'Goldsturm' seed, including Benary (ApeX), Jelitto (Gold Nugget<sup>®</sup>), and Kieft (TunedSeed<sup>®</sup>). Our trial results with each product have unfortunately been inconsistent from seed lot to seed lot.

Germination of enhanced seed, regardless of supplier, generally ranges from 60%–90% in our experience. At least some of the inconsistent performance may be due to shelf-life issues with the enhanced products.

Methods for enhancing 'Goldsturm' seed are secret and proprietary. The treatments may include priming, hormone treatment (gibberellic acid), or multi-step processes. Raker uses our own proprietary seed treatment when enhanced 'Goldsturm' seed is not available from suppliers.

- of a priority conservation wetland, Vermont, U.S. *J. Environ. Qual.* 31:350–357.
- Hartmann, H.T., D.E. Kester, F.T. Davies, Jr., and R.L. Geneve.** 2002. Plant propagation: Principals and practices. 7th ed. Prentice Hall Inc., Englewood Cliffs, New Jersey.
- Kraus, H.T., S.L. Warren, and C.E. Anderson.** 2002. Nitrogen form affects growth, mineral nutrient content, and root anatomy of *Cotoneaster* and *Rudbeckia*. *HortScience* 37:126–129.
- Lea-Cox, J.D., and D.S. Ross.** 2001. A review of the Federal Clean Water Act and the Maryland Water Quality Improvement Act: The rationale for developing a water and nutrient management planning process for container nursery and greenhouse operations. *J. Environ. Hort.* 19:226–229.
- Lea-Cox, J.D., D.S. Ross, and K.M. Tefteau.** 2001. A water and nutrient management planning process for container nursery and greenhouse production systems in Maryland. *J. Environ. Hort.* 19:230–236.
- Mengel, K., and E.A. Kirkby.** 2001. Principals of plant nutrition. Kulwer Academic Pub. Dordrecht, the Netherlands.
- Million, J., T. Yeager, H. Bryant, C. Larsen, J. Shook, and J. Albaro.** 2005. Effects of slope and underlay on surface runoff of irrigation from woven polypropylene ground-cloth. *HorTech.* 154:772–776.
- Perry, L.P., and S.A. Adam Jr.** 1990. Nitrogen nutrition of container grown *Hemerocallis* × '*Stella de Oro*'. *J. Environ. Hort.* 8:19–21.
- Rowe, D.B., and B.M. Cregg.** 2002. Effects of incorporating controlled-release fertilizer on adventitious rooting and growth of *Artemisia*, *Gaura*, and *Nepeta*. *J. Environ. Hort.* 20:1–6.

---

## Germination of *Rudbeckia fulgida* var. *sullivantii* 'Goldsturm'<sup>®</sup>

**Allen R. Pyle**

C. Raker & Sons, Inc., 10371 Rainey Rd., Litchfield, Michigan 49252 U.S.A.

### INTRODUCTION

*Rudbeckia fulgida* var. *sullivantii* 'Goldsturm' is a popular, award-winning perennial. It has consistently remained a top-three-selling perennial at Raker over the last 10 years. Raker annually produces in excess of 2 million 'Goldsturm' plugs from seed.

Like many perennials, consistent success with germinating *Rudbeckia* 'Goldsturm' is challenging, as germination and seed vigor can vary significantly from seed lot to seed lot, regardless of supplier. In our experience, 'Goldsturm' germination typically ranges from 20%–80% for standard lots.

### ENHANCED SEED

There are now multiple suppliers offering enhanced 'Goldsturm' seed, including Benary (ApeX), Jelitto (Gold Nugget<sup>®</sup>), and Kieft (TunedSeed<sup>®</sup>). Our trial results with each product have unfortunately been inconsistent from seed lot to seed lot.

Germination of enhanced seed, regardless of supplier, generally ranges from 60%–90% in our experience. At least some of the inconsistent performance may be due to shelf-life issues with the enhanced products.

Methods for enhancing 'Goldsturm' seed are secret and proprietary. The treatments may include priming, hormone treatment (gibberellic acid), or multi-step processes. Raker uses our own proprietary seed treatment when enhanced 'Goldsturm' seed is not available from suppliers.

## GERMINATION ENVIRONMENT

Temperature is a critical factor in germination of 'Goldsturm'. Traditional germination techniques usually involve cold stratification (40–50 °F, 4–10 °C) for several weeks before moving trays to a warm (70–75 °F, 21–24 °C) environment.

Raker uses a warm (85 °F, 30 °C), lit germination chamber for germinating 'Goldsturm'. Trays remain in the warm chamber for 4 days after sowing and are then moved into a greenhouse at 72–75 °F (22–24 °C).

Trays in the germination chamber are wrapped individually in clear plastic to ensure high humidity and proper moisture levels. Light enhances germination in 'Goldsturm', so seed is not covered.

## SOWING

To help ensure good plant stands and meet our guaranteed tray counts, we sow multiple 'Goldsturm' seeds per cell in trays. For 288 trays, we sow two seeds per cell; for 128s, three seeds per cell. We also sow extra trays to use in the patching process ("overstart"), to help ensure can-ship full-plug trays. Overstart for 'Goldsturm' is 40% extra trays, regardless of tray size.

Ensuring good sowing accuracy, with seeds placed directly in the centers of cells, is important in producing high quality seedlings. Seeder operators should be trained well enough to understand their equipment and how to get the best efficiency and accuracy from it.

## CROP TIMING

Crop timing for plug production is generally 6–7 weeks to finish a 288-cell plug and 8–9 weeks to finish a 128-cell plug.

---

# Propagation of *Sarracenia* Species®

**Randolph A. Heffner**

Aquascapes Unlimited Inc., Pipersville, Pennsylvania 18947 U.S.A.

## INTRODUCTION

The notion that the Sarraceniaceae family of carnivorous plants evolved recently in geological time can be attributed to a complete lack of any fossil records (D'Amato, 1998). Most carnivorous plants evolved modified leaves as a survival mechanism to supplement low mineral and nutrient levels. Low nutrient availability within the root zone is due to the inherent wet, mineral deficient, acidic, peaty soils of the habitats in which they are found. North America has probably the widest range of carnivorous plants in the world — most *Sarracenia* species are found in the southeast United States of America (Schnell, 2002). Charles Darwin, among others, studied carnivores and published *Insectivorous Plants* in the 1875.

Carnivorous plants have developed various methods to capture animals; primarily these techniques of capture can be divided into "passive" and "active" methods. All *Sarracenia*s use the passive method of "pitfall." In order to be considered a "carnivorous plant," a plant must lure, catch, kill, and digest its prey (D'Amato, 1998). Glands in the modified leaf shoots of many carnivorous families often produce digestive enzymes. The Victorian botanist, Sir Joseph D. Hooker (1859), was the first

## GERMINATION ENVIRONMENT

Temperature is a critical factor in germination of 'Goldsturm'. Traditional germination techniques usually involve cold stratification (40–50 °F, 4–10 °C) for several weeks before moving trays to a warm (70–75 °F, 21–24 °C) environment.

Raker uses a warm (85 °F, 30 °C), lit germination chamber for germinating 'Goldsturm'. Trays remain in the warm chamber for 4 days after sowing and are then moved into a greenhouse at 72–75 °F (22–24 °C).

Trays in the germination chamber are wrapped individually in clear plastic to ensure high humidity and proper moisture levels. Light enhances germination in 'Goldsturm', so seed is not covered.

## SOWING

To help ensure good plant stands and meet our guaranteed tray counts, we sow multiple 'Goldsturm' seeds per cell in trays. For 288 trays, we sow two seeds per cell; for 128s, three seeds per cell. We also sow extra trays to use in the patching process ("overstart"), to help ensure can-ship full-plug trays. Overstart for 'Goldsturm' is 40% extra trays, regardless of tray size.

Ensuring good sowing accuracy, with seeds placed directly in the centers of cells, is important in producing high quality seedlings. Seeder operators should be trained well enough to understand their equipment and how to get the best efficiency and accuracy from it.

## CROP TIMING

Crop timing for plug production is generally 6–7 weeks to finish a 288-cell plug and 8–9 weeks to finish a 128-cell plug.

---

# Propagation of *Sarracenia* Species®

**Randolph A. Heffner**

Aquascapes Unlimited Inc., Pipersville, Pennsylvania 18947 U.S.A.

## INTRODUCTION

The notion that the Sarraceniaceae family of carnivorous plants evolved recently in geological time can be attributed to a complete lack of any fossil records (D'Amato, 1998). Most carnivorous plants evolved modified leaves as a survival mechanism to supplement low mineral and nutrient levels. Low nutrient availability within the root zone is due to the inherent wet, mineral deficient, acidic, peaty soils of the habitats in which they are found. North America has probably the widest range of carnivorous plants in the world — most *Sarracenia* species are found in the southeast United States of America (Schnell, 2002). Charles Darwin, among others, studied carnivores and published *Insectivorous Plants* in the 1875.

Carnivorous plants have developed various methods to capture animals; primarily these techniques of capture can be divided into "passive" and "active" methods. All *Sarracenia*s use the passive method of "pitfall." In order to be considered a "carnivorous plant," a plant must lure, catch, kill, and digest its prey (D'Amato, 1998). Glands in the modified leaf shoots of many carnivorous families often produce digestive enzymes. The Victorian botanist, Sir Joseph D. Hooker (1859), was the first



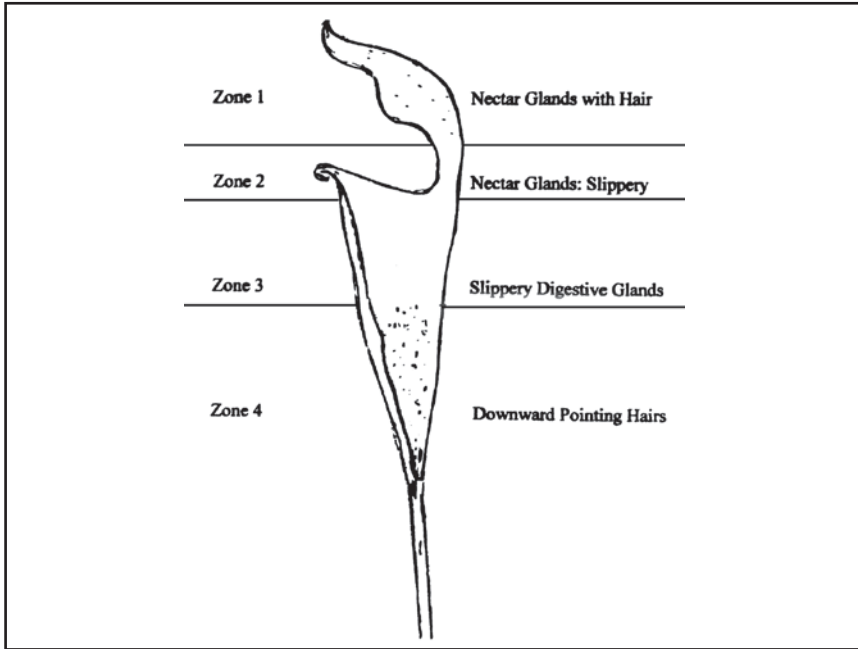


Figure 1. Zonation.

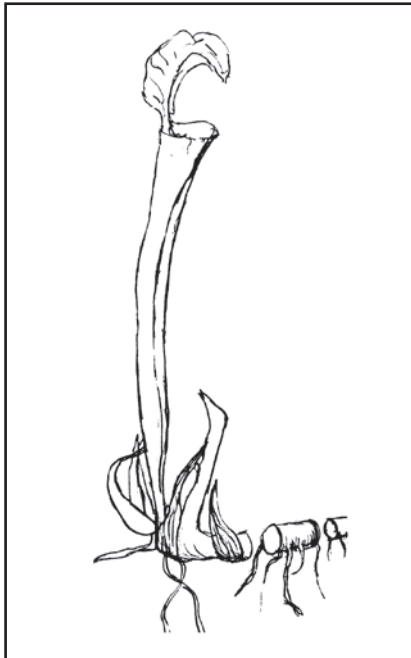


Figure 2. Division of *Sarracenia* rhizome.

to identify four distinct zones within the modified tube leaves of the *Sarracenia* species (Fig. 1).

During the late 1800s commercial nurseries provided a source for unusual exotic plants from all over the world. Among these were members of the Sarraceniaceae family. Many colorful hybrids were produced and subsequently lost over the years. Venus flytraps revived the craze for carnivorous plants in the 1960s. In the 1970s several individuals, including Don Schnell, produced a newsletter and formed the International Carnivorous Plant Society (Slack, 1998). In the 1980s and 1990s huge areas of carnivorous plant habitat were transformed and lost to development, roadways, and forestry. Vegetative propagation through tissue culture and traditional methods has increased proportionally to meet increasing demand for plant material. Seed production/hybridization of existing complex

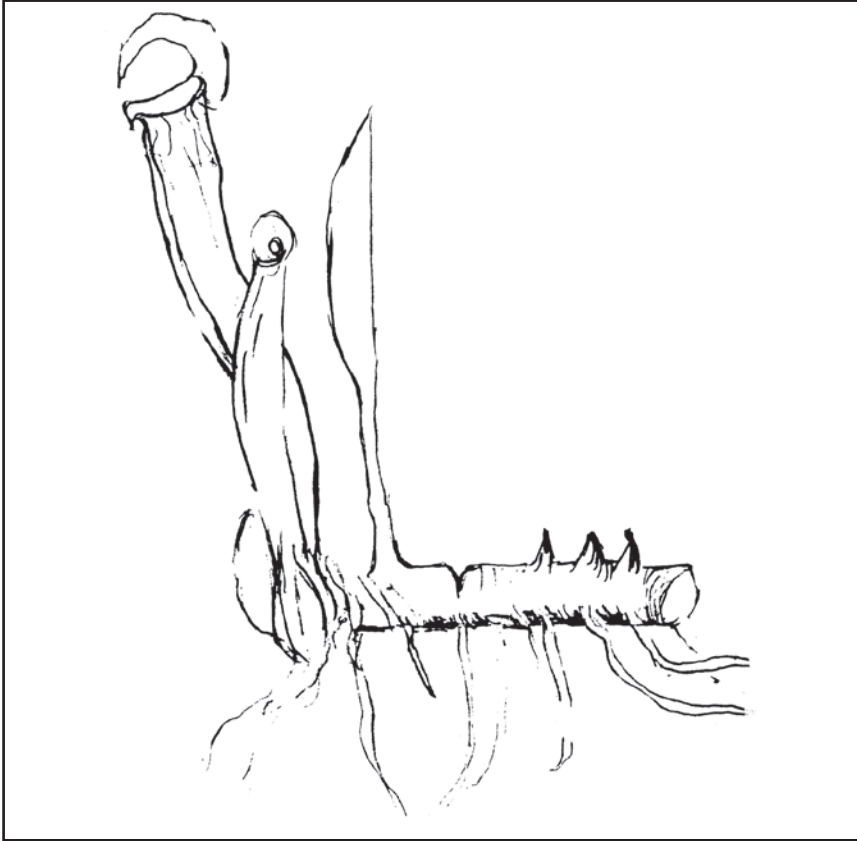
and simple crosses continues to be a source for new seemingly endless range of propagules, many of which exceed the beauty of the natural hybrids found in the world (Mellichamp, 2000).

## PROPAGATION

**Vegetative.** Most *Sarracenia*s produce offshoots of new growing plants along a rhizome. Some species such as *S. purpurea* and *S. psittacina* are extremely slow. We have observed *S. rubra* producing up to 10 offshoots per year. We have found January through February to be most favorable for vegetative divisions in our 60 °F production greenhouse. We divide only after dormancy has broken but prior to the actual growth period where flower buds and new tubes have emerged. Growing tips can be identified easily at this time because they often become enlarged and sprout new roots at the terminal end. The shoots are manipulated in such a way as to delicately snap the offshoot from the longer rhizome sections. A properly harvested propagule should be white inside and have some roots attached (Fig. 2). Notching of the *Sarracenia* rhizome is another method of vegetative production. In this method, the growing tip is allowed to remain growing attached, and “V”-shaped notches are made along the surface of the elongated rhizome. The rhizome is exposed to filtered light, and new growing points often appear along these cuts. Care must be given to prevent fungal infections. Healthy old gnarly rhizomes without growing tips may also be used with some success (Fig. 3).

Vegetative propagules are sized and planted into appropriately sized seed cells filled with pre-moistened 1 perlite : 1 peat moss (v/v) mix. The top of the rhizome should be placed at the surface of the medium and the roots buried under the medium. The propagules are then watered in with a fine mist from overhead and resituated within the media mix if necessary. Thereafter all watering is done via bottom up method with alternated wet/dry periods. The plants must never be allowed to dry out completely. However the “drying down” of the medium increases oxygen concentration within the root zone, helping to promote more root development, which increases survival rate. Fertilizers can be applied routinely with caution at approximately 20% the recommended rate during the active growth period. As with watering, liquid fertilizers are added to the cells bottom up and allowed to come in contact with the root zone for approximately 24 h, after which the fertilizer solution is flushed out from above using overhead irrigation. Neutral, low mineral water must be used in order to flush out any residual salts. *Sarracenia*s as well as most carnivorous plants are salt intolerant. Propagules vary in their growth rates according to their individual vigor, specific species, or cultivar type. A 2-inch × 2-inch plug can be produced in 1 year. A typical 2-inch × 2-inch plug will generally fill out a 1-qt container in the 2nd year. Most species take at least 4–5 years to reach maturity, bloom, and produce seed.

**Seed.** *Sarracenia* flowers are perfectly designed for cross-pollination by bees, although self-pollination is possible. Petals remain open for 1–2 weeks. Pollen will drop when ripe into the umbrella shaped styles. Pollen can be transferred between open flower stigmas or its own to self-pollinate. Pollen stores several weeks in the fridge in dry sealed containers. Phil Sheridan of Woodford, Virginia, has reported dry pollen stored at freezing temperatures may be viable for months (Sheridan, 2004).



**Figure 3.** Notching a *Sarracenia* rhizome will usually encourage new growing tips.

Reciprocal crosses should be done if possible. All crosses are labeled and documented. When possible, record any and all information about parental heritage, origin, date acquired, etc. Petals drop off after 2 weeks; the umbrella style and sepals remain. The ovary continues to ripen throughout the summer. In fall the seed pod often splits. Up to 200 seeds may be produced in one pod. The seeds are reddish brown and the size of a pinhead. Seed can be stored dry in airtight containers at 35–40 °F for several years without significant losses. All *Sarracenia* seeds should be cold wet stratified prior to sowing for at least 30 days. In a warm greenhouse the best time for sowing is early spring/late winter when daylight hours are increasing and soil temperatures are rising. Germination rates of 90% are not uncommon if fresh seed is sown when ambient temperatures are at least 70 °F during the daytime and 40 °F at night. As with most wetland obligate species, seed must be surface sown and watered in lightly. The medium is 1 sand : 1 peat moss (v/v) mix. Germination occurs within 10–20 days. Seed trays are kept at constant moisture levels and allowed to remain in full sun. Seedlings are sorted, sized, and graded in July and placed in appropriately sized cells.

**Table 1.** Simple *Sarracenia* hybrids.

<i>S. × catesbaei</i>	=	<i>S. purpurea × flava</i>
<i>S. × moorei</i>	=	<i>S. flava × leucophylla</i>
<i>S. × popei</i>	=	<i>S. flava × rubra</i>
<i>S. × harperi</i>	=	<i>S. flava × minor</i>
<i>S. × mitchelliana</i>	=	<i>S. purpurea × leucophylla</i>
<i>S. × exornata</i>	=	<i>S. purpurea × alata</i>
<i>S. × chelsonii</i>	=	<i>S. purpurea × rubra</i>
<i>S. × courtii</i>	=	<i>S. purpera × psittacina</i>
<i>S. × areolata</i>	=	<i>S. leucophylla × alata</i>
<i>S. × readii</i>	=	<i>S. leucophylla × rubra</i>
<i>S. × excellens</i>	=	<i>S. leucophylla × minor</i>
<i>S. × wrigleyana</i>	=	<i>S. leucophylla × psittacina</i>
<i>S. × ahlesii</i>	=	<i>S. alata × rubra</i>
<i>S. × rehderi</i>	=	<i>S. rubra × minor</i>
<i>S. × gilpini</i>	=	<i>S. psittacina</i>
<i>S. × formosa</i>	=	<i>S. minor × psittacina</i>

**LITERATURE CITED**

- D'Amato P.** 1998. The savage garden. Ten Speed Press. Berkley, California.
- Darwin, C.** 1875. Insectivorous plants. John Murray. London.
- Hooker, J.D.** 1859. The Origin and development of the pitcher of *Sarracenia*. Linnean Soc. Trans.
- Mellichamp, L.** 2000. Biology Department, University North Carolina, Charlotte, North Carolina. Pers. Comm.
- Schnell, P.E.** 2002. Carnivorous plants of the United States and Canada. Timber Press, Portland, Oregon.
- Sheridan, P.** 2004. Meadowview Biological Research Station, Woodford, Virginia. Pers. Comm.
- Slack, A** 1988. Carnivorous plants. MIT Press, Cambridge, Massachusetts.

# Asters in the Mid-Atlantic Region: Performance Evaluation and Recommendations for Landscape Use<sup>©</sup>

Jeanne Frett and Victor Piatt

Mt. Cuba Center, Inc., Box 3570, Barley Mill Road, Greenville, Delaware 19807-0570 U.S.A.

## INTRODUCTION

Those of you who have kept abreast of recent changes in nomenclature will find it surprising that the topic of this presentation is eastern North American asters, since the taxonomists now state that the genus *Aster* is restricted to Eurasia. Those species that were formerly classified as being in the genus *Aster* have now been divided into separate genera, including: *Symphotrichum*, *Ionactis*, *Eurybia*, *Sericocarpus*, *Doellingeria*, *Ampelaster*, and *Oclemena*.

In 1994, Dr. Guy Nesom, a research botanist, attempted to reclassify the genus into a number of smaller units based on morphology (form and structure) and chromosomes. He concluded that none of the American so-called asters were closely related to Eurasian asters. This was initially met with skepticism, but subsequent molecular and taxonomic research supported Nesom's hypothesis. At Mt. Cuba we have decided to adopt these new names in our plant record system and signage. However, in this presentation, I will continue to list them as asters to avoid confusion, adding their new names as a subtitle.

Asters belong to the daisy family, formerly Composite, now Asteraceae. The flowers at the center of the daisy are really groups (inflorescences) of small fertile flowers, generally yellow, called disk florets, which provide nectar and pollen to visiting insects. These are surrounded by structures that look like petals but are actually ray florets, ranging in color from white through pink, blue, and purple, lengthened in design through evolution to attract insects.

## DESCRIPTION OF EVALUATION PROJECT

Asters, the "stars of autumn," are invaluable additions to the late-season garden. They are suitable for many sites and styles of gardening, from rock gardens and meadows to formal bedding and ecological restoration, and are easily grown and propagated.

In 2002, Mt. Cuba Center, located near Wilmington, Delaware (USDA Hardiness Zone 7A/6B) initiated a project to evaluate 56 commercially available species and cultivars of asters predominantly native to the Eastern U.S.A., making a special point to include lesser-known species that have not been fully evaluated for their potential ornamental use. Data were collected from 2003–2005. Our goal was to recommend superior taxa based on the following observations: floral display (flower color, inflorescence size, flower coverage, bloom period); habit (height, width, foliage quality); habit quality (need for staking or pinching); winter hardiness; cultural adaptability; and disease and pest resistance. Ratings were based on a 1–5 scale; 1 = very poor, 5 = excellent. See Table 1 for a summary of this information.

All plants were grown in an 11,000 sq. ft. trial garden, protected by an 18- to 36-inch wire fence, within a 100-acre garden protected by a 10-ft deer exclusion fence. Most beds were in full sun; partial shade was provided to woodland species by several nearby mature pines and sweet gum trees located outside the fence. The clay-loam soil in the trial garden, site of a former cut flower garden, had been amended

Table 1. Asters in the Mid-Atlantic region: Performance evaluation summary.

Aster taxa	Flower color/RHS no.	Flower size (inches)	Peak bloom	Bloom period	Size (inches) (H x W)	Rating*
<i>Ampelaster carolinianus</i> (syn. <i>A. carolinianus</i> )	light violet blue (84B/C)	1 <sup>1</sup> / <sub>4</sub>	11/26	mid Nov – early Dec	83 x 41	3.9
<i>Doellingeria umbellata</i> (syn. <i>A. umbellatus</i> )	white (white)	1/2 – 3/4	8/18	late July – late Aug	23 x 52	4.7
<i>Eurybia divaricata</i> 'Eastern Star' (syn. <i>A. divaricata</i> 'Eastern Star')	white (white)	3/4	9/24	early Sept – mid Oct	25 x 50	4.5
<i>Eurybia divaricata</i> 'Silver Spray' (syn. <i>A. divaricata</i> 'Silver Spray')	white (white)	3/4 – 1	9/10	early – late Sept	40 x 70	4.6
<i>Eurybia divaricata</i> "Raiche Form" (syn. <i>A. divaricata</i> "Raiche Form")	white (white)	3/4 – 1	9/10	late Aug – late Sept	21 x 63	4.6
<i>Eurybia hemispherica</i> <i>A. paludosus</i> subsp. <i>hemisphericus</i> )	dark violet blue (90A-D)	1 <sup>1</sup> / <sub>8</sub> – 1 <sup>1</sup> / <sub>2</sub>	9/22	mid Sept – early Oct	23 x 44	4.5
<i>Eurybia macrophylla</i> (syn. <i>A. macrophyllus</i> )	light violet blue (91B)	1 – 1 <sup>1</sup> / <sub>4</sub>	9/5	late Aug – late Sept	49 x 55	4.2
<i>Eurybia macrophylla</i> 'Albus' (syn. <i>A. macrophyllus</i> 'Albus')	white (white)	3/4 – 1 <sup>1</sup> / <sub>4</sub>	7/21	late July – late Aug	35 x 74	4.3
<i>Eurybia schreberi</i> (syn. <i>A. schreberi</i> )	white (white)	3/4 – 1	7/21	mid July – mid Aug	32 x 19	4.4
<i>Eurybia spectabilis</i> (syn. <i>A. spectabilis</i> )	medium violet (85 A/B)	2 – 2 <sup>1</sup> / <sub>4</sub>	9/24	early Sept – early Oct	14 x 60	4.5
<i>Eurybia</i> x <i>herveyi</i> (syn. <i>A.</i> x <i>herveyi</i> )	light violet (85B)	1 – 1 <sup>1</sup> / <sub>4</sub>	9/15	mid Aug – early Oct	37 x 41	4
<i>Ionactis tinariifolium</i> (syn. <i>A. tinariifolius</i> )	light violet (88D)	1 – 1 <sup>1</sup> / <sub>4</sub>	9/22	early – late Sept	15 x 25	4.6
<i>Oclemena acuminata</i> (syn. <i>A. acuminatus</i> )	white (white)	3/4 – 1	9/18	early – late Sept	31 x 57	4.6

<i>Oclemena nemoralis</i> (syn. <i>A. nemoralis</i> )	medium purple (75A)	1	9/1	late Aug – early Sept	11 × 40	3.9
<i>Symphotrichum concolor</i> (syn. <i>A. concolor</i> )	medium violet blue (90C/D)	3/4 – 1	10/25	mid Oct – late Nov	19 × 35	dead
<i>Symphotrichum cordifolium</i> (syn. <i>A. cordifolius</i> )	light violet (85C)	1/2 – 5/8	10/7	late Sept – late Oct	34 × 77	4.4
<i>Symphotrichum cordifolium</i> 'Photograph'	light purple (76A)	1 – 1 1/4	9/24	late Sept – late Oct	36 × 56	4.2
<i>Symphotrichum drummondii</i> (syn. <i>A. drummondii</i> )	light violet (85B)	3/4 – 1	10/7	mid Sept – mid Oct	60 × 80	4.5
<i>Symphotrichum dumosum</i> (syn. <i>A. dumosus</i> )	light violet (85A/B)	5/8	9/15	late Aug – late Sept	48 × 45	4.6
<i>Symphotrichum dumosum</i> 'Rose Serenade'	light purple (76A)	1 – 1 1/4	9/24	mid Sept – mid Oct	27 × 62	4.3
<i>Symphotrichum dumosum</i> 'Rose Serenade'	light purple (76A)	1 – 1 1/4	9/24	mid Sept – mid Oct	27 × 62	4.3
<i>Symphotrichum eliotii</i> ( <i>A. eliotii</i> )	medium purple (77C)	1 – 1 7/8	12/3	late Nov – early Dec	80 × 72	3.6
<i>Symphotrichum ericoides</i> 'Pink Star'	light purple violet (80B/C)	3/4 – 7/8	9/22	mid Sept – mid Oct	60 × 36	3.8
<i>Symphotrichum ericoides</i> var. <i>prostratum</i> 'Snow Flurry'	white (white)	1/4	10/14	mid – late Oct	9 × 50	3.8
(syn. <i>A. ericoides</i> f. <i>prostratus</i> 'Snow Flurry')						
<i>Symphotrichum georgianum</i> (syn. <i>A. georgianus</i> )	medium violet (88A)	2 1/4 – 2 1/2	11/4	mid Oct – late Nov	48 × 80	4
<i>Symphotrichum grandiflorum</i> (syn. <i>A. grandiflorus</i> )	medium violet (88A)	1 1/2 – 1 1/4	10/27	mid Oct – late Nov	46 × 72	4.6
<i>Symphotrichum laevis</i> 'Bluebird'	medium violet blue (90D)	1 1/4 – 1 1/2	9/27	late Sept – late Oct	48 × 40	4.8
(syn. <i>A. laevis</i> 'Bluebird')						
<i>Symphotrichum laevis</i> 'Calliope'	medium violet (85A/B)	1 – 1 1/2	9/26	mid Sept – early Oct	32 × 67	2.6
(syn. <i>A. laevis</i> 'Calliope')						



<i>Symphytotrichum lanceolatum</i> (syn. <i>A. lanceolatus</i> )	light violet (85C)	$\frac{3}{4}$ – 1	9/18	early – late Sept	50 × 36	3.5
<i>Symphytotrichum lateriflorum</i> 'Lady in Black' (syn. <i>A. lateriflorus</i> ) 'Lady in Black'	white (white)	$\frac{1}{2}$	9/30	mid Sept – mid Oct	45 × 55	4.5
<i>Symphytotrichum lateriflorum</i> 'Lovely' (syn. <i>A. lateriflorus</i> 'Lovely')	light violet (84C)	$\frac{1}{2}$	9/18	early – late Sept	30 × 52	4.7
<i>Symphytotrichum novae-angliae</i> 'Andenkenan Alma Pötschke' (syn. <i>A. novae-angliae</i> ) 'Andenkenan Alma Pötschke'	medium red purple (67A/B)	$1\frac{1}{4}$ – $1\frac{1}{2}$	9/20	mid Sept – early Oct	37 × 45	3.6
<i>Symphytotrichum novae-angliae</i> 'Barr's Blue' (syn. <i>A. novae-angliae</i> ) 'Barr's Blue'	medium violet (88B)	$1\frac{3}{4}$ – 2	9/30	mid Sept – early Oct	38 × 36	3.9
<i>Symphytotrichum novae-angliae</i> 'Hella Lacy' (syn. <i>A. novae-angliae</i> ) 'Hella Lacy'	medium violet (88A/B)	$1\frac{1}{2}$ – $1\frac{3}{4}$	9/27	mid Sept – early Oct	52 × 48	2.5
<i>Symphytotrichum novae-angliae</i> 'Honeysong Pink' (syn. <i>A. novae-angliae</i> ) 'Honeysong Pink'	medium red purple (70B/C)	$1\frac{1}{4}$ – $1\frac{1}{2}$	9/20	early – late Sept	61 × 48	3.5
<i>Symphytotrichum novae-angliae</i> 'Lachsglut' (syn. <i>A. novae-angliae</i> ) 'Lachsglut'	medium red purple (68A/B)	$1\frac{1}{4}$ – $1\frac{1}{2}$	9/24	mid – late Sept	58 × 45	3.5
<i>Symphytotrichum novae-angliae</i> 'Mrs. S.T. Wright' (syn. <i>A. novae-angliae</i> ) 'Mrs. S.T. Wright'	medium violet (88C)	2 – $2\frac{1}{2}$	9/24	mid – late Sept	38 × 64	3.9
<i>Symphytotrichum novae-angliae</i> 'Purple Dome' (syn. <i>A. novae-angliae</i> ) 'Purple Dome'	medium violet (87A)	$1\frac{1}{2}$ – $1\frac{3}{4}$	9/24	mid Sept – early Oct	25 × 44	3.9
<i>Symphytotrichum novae-angliae</i> 'Rosa Seiger' (syn. <i>A. novae-angliae</i> ) 'Rosa Seiger'	medium red purple (64B/C)	$1\frac{1}{4}$ – $1\frac{1}{2}$	9/24	mid – late Sept	36 × 72	3.9

<i>Symphotrichum novi-belgii</i> 'Alert' (syn. <i>A. novi-belgii</i> 'Alert')	medium purple violet (80A)	1 – 1 <sup>1</sup> / <sub>8</sub>	9/20	mid – late Sept	17 × 28	4.4
<i>Symphotrichum novi-belgii</i> 'Heinz Richard' (syn. <i>A. novi-belgii</i> 'Heinz Richard')	medium purple violet (82C)	1 <sup>1</sup> / <sub>8</sub> – 1 <sup>1</sup> / <sub>4</sub>	9/20	mid – late Sept	20 × 36	4.1
<i>Symphotrichum novi-belgii</i> 'Nesthäkchen' (syn. <i>A. novi-belgii</i> 'Nesthäkchen')	medium violet (84B/C)	1 – 1 <sup>1</sup> / <sub>4</sub>	9/20	mid – late Sept	16 × 30	3.4
<i>Symphotrichum novi-belgii</i> 'Richness' (syn. <i>A. novi-belgii</i> 'Richness')	medium violet (87A)	1 <sup>1</sup> / <sub>8</sub> – 1 <sup>1</sup> / <sub>4</sub>	9/20	mid – late Sept	37 × 72	2.9
<i>Symphotrichum novi-belgii</i> 'Wood's Light Blue' (syn. <i>A. novi-belgii</i> 'Wood's Light Blue')	medium violet blue (90C/D)	1 <sup>1</sup> / <sub>4</sub>	9/20	mid – late Sept	22 × 42	3.5
<i>Symphotrichum novi-belgii</i> 'Wood's Pink' (syn. <i>A. novi-belgii</i> 'Wood's Pink')	light red purple (74D)	1 <sup>1</sup> / <sub>8</sub> – 1 <sup>1</sup> / <sub>2</sub>	9/20	mid – late Sept	16 × 33	3.5
<i>Symphotrichum novi-belgii</i> 'Wood's Purple' (syn. <i>A. novi-belgii</i> 'Wood's Purple')	medium violet (88B/C)	1 – 1 <sup>1</sup> / <sub>4</sub>	9/20	mid – late Sept	14 × 32	4.6
<i>Symphotrichum oblongifolium</i> (syn. <i>A. oblongifolius</i> var. <i>angustatus</i> )	medium violet blue (90C)	1 <sup>1</sup> / <sub>2</sub> – 1 <sup>3</sup> / <sub>4</sub>	11/1	mid Oct – mid Nov	31 × 48	4.4
<i>Symphotrichum oblongifolium</i> 'Fanny's' (syn. <i>A. oblongifolius</i> 'Fanny's')	medium violet blue (90C)	1 <sup>1</sup> / <sub>2</sub> – 1 <sup>3</sup> / <sub>4</sub>	11/15	late Oct – late Nov	35 × 76	4.3
<i>Symphotrichum oblongifolium</i> 'October Skies' (syn. <i>A. oblongifolius</i> 'October Skies')	medium violet blue (90B/C)	1 <sup>1</sup> / <sub>8</sub> – 1 <sup>1</sup> / <sub>4</sub>	10/14	late Sept – late Oct	25 × 38	4.7
<i>Symphotrichum oblongifolium</i> 'Raydon's Favorite' (syn. <i>A. oblongifolius</i> 'Raydon's Favorite')	medium violet blue (90C)	1 <sup>3</sup> / <sub>4</sub>	10/24	mid Oct – mid Nov	36 × 72	4.6

<i>Symphotrichum patens</i> (syn. <i>A. patens</i> )	dark violet (88A)	1 – 1 <sup>1</sup> / <sub>8</sub>	10/7	late Sept – mid Oct	37 × 18	3.4
<i>Symphotrichum pilosum</i> (syn. <i>A. pilosus</i> )	white (white)	<sup>5</sup> / <sub>8</sub>	9/25	mid Sept – mid Oct	54 × 48	3.4
<i>Symphotrichum prenanthoides</i> (syn. <i>A. prenanthoides</i> )	medium violet blue (91A)	<sup>5</sup> / <sub>8</sub>	9/30	mid Sept – mid Oct	48 × 87	3.4
<i>Symphotrichum puniceum</i> (syn. <i>A. puniceus</i> )	medium violet blue (94C)	1 – 1 <sup>1</sup> / <sub>4</sub>	10/3	late Sept – late Oct	93 × 180	3.7
<i>Symphotrichum reflexum</i> (syn. <i>A. retroflexus</i> )	medium violet blue (90D)	1 <sup>1</sup> / <sub>4</sub> – 1 <sup>1</sup> / <sub>2</sub>	9/30	late Sept – mid Oct	45 × 29	4.1
<i>Symphotrichum turbinellum</i> (syn. <i>A. turbinellus</i> )	medium violet (85A/B)	1 <sup>1</sup> / <sub>4</sub> – 1 <sup>1</sup> / <sub>2</sub>	10/7	late Sept – mid Oct	38 × 68	4.8

\* Overall Ratings — 5 = excellent, 4 = good, 3 = fair, 2 = poor, 1 = very poor

over the years with composted leaves. It had an average pH of 7.0. The planting rows were mounded 2–4 inches to assure good drainage.

Maintenance was minimal to simulate home gardening conditions. Beds were periodically weeded and hand watered during periods of drought. The beds were not fertilized and were mulched with shredded leaves and hardwood bark. Plants were routinely deadheaded to prevent reseeding. Winter protection was not provided.

### TOP-RATED ASTERS

*Symphotrichum laeve* 'Bluebird' (syn. *Aster laevis* 'Bluebird', smooth aster). The reasons for its high rating include attractive and pest-free foliage that is generally pleasing throughout the seasons, vigorous, upright habit that under most conditions does not require staking and can be controlled through pinching, excellent flower coverage and quality, and drought tolerance. It may grow taller and perhaps open up on rich soils.

*Symphotrichum turbinellum* (syn. *Aster turbinellus*, prairie aster). This aster was highly rated because of its attractive mounding habit, excellent foliage and flower texture and color, excellent flower coverage, health, and vigor. It is drought tolerant and disease resistant. It may open up on rich soils, but because of its billowy habit, the overall appearance it not unattractive.

*Symphotrichum lateriflorum* 'Lovely' (syn. *Aster lateriflorus* 'Lovely'), calico aster. Reasons for recommendation include its dwarf, bushy habit and texture reminiscent of a dwarf conifer, excellent flower number and coverage, drought and disease tolerance, and its attractive appearance without the need of frequent division. When in flower, it hums with insects,

making it a great pollinator. As the plant ages, it has a slight tendency to open up in the middle.

***Symphotrichum oblongifolium* ‘October Skies’ (syn. *Aster oblongifolius* ‘October Skies’), aromatic aster.** It is recommended because of its smaller stature and tighter habit compared to *S. oblongifolium* ‘Raydon’s Favorite’ and var. *angustatus*, its aromatic foliage, disease and pest resistance, attractive flower color, coverage and persistence, mounding, cloud-like habit, and vigor. It doesn’t need pinching, and the branches support each other; if the foliage opens up it fills in with time.

***Doelingeria umbellata* (syn. *Aster umbellatus*), flat-topped white aster.** We rated this plant highly because of its attractive floral display that fades to an attractive greenish white color for weeks after peak bloom and its clean, neat foliage, attractively arranged on the stems that are ornamental and can stand alone after the plant flowers. It is drought tolerant and pest and disease resistant.

***Oclemena acuminata* (syn. *Aster acuminatus*), mountain aster.** This plant received a high rating because of its attractive foliage, initially light to medium green, acquiring coppery overtones as it matures, which remains ornamentally attractive throughout the season. It has burgundy stems and a pleasing mounding habit. The flowers are well presented at the ends of the stems, and there is a pleasing contrast between the white flowers and the foliage. If the stems do splay as they mature, the plant throws new stems at its middle, making it a good groundcover.

***Eurybia divaricata* “Raiche Form” (syn. *Aster divaricatus* “Raiche Form”), white wood aster.** This plant can be recommended because of its attractive foliage, mounding habit, pleasing arrangement and excellent coverage of nice-sized flowers. Multiple pinching produces a more attractive habit and prevents splaying. It is tolerant of dry shade and disease and pest resistant. *Eurybia divaricata* ‘Silver Spray’ is very similar in appearance but did not seem quite as vigorous in our trial.

***Symphotrichum dumosum* (syn. *Aster dumosus*), bushy aster.** The reason for its high rating is because of its attractive flower color displayed well around the stem, clean foliage that persists so that it doesn’t become bare-kneed, and disease and pest resistance. It performed well during a very wet summer. Pinching the plant early in the season produces a denser floral display.

***Symphotrichum grandiflorum* (syn. *Aster grandiflorus*), large-flowered aster.** It forms an attractive upright oval, which can be pinched to produce a bushier habit and denser floral display. It performed well throughout a wet year, is pest and disease resistant, and does not need frequent division.

***Ionactis linariifolium* (syn. *Aster linariifolius*), stiff aster.** It is highly recommended because of its low stature, conifer-like texture, upright-facing flowers produced in abundance, disease and pest resistance, and drought tolerance. It occasionally opens up in the center but will fill in with time. It doesn’t need frequent division.

***Symphotrichum drummondii* (syn. *Aster drummondii*), Drummond’s aster.** It has potential as a cut flower, is pest and disease resistant, and drought tolerant.

***Symphotrichum novi-belgii* ‘Wood’s Purple’ (syn. *Aster novi-belgii* ‘Wood’s Purple’), New England aster.** It is recommended because of its relatively clean

foliage, rich flower color, vigor, attractive low mounding habit with or without pinching, branches that do not splay open, and almost complete flower coverage

***Eurybia hemispherica* (syn. *Aster paludosus* subsp. *hemisphericus*), prairie wood aster.** This plant is recommended because of its very attractive flower color, pleasing and unusual foliage texture, relatively clean foliage, and spreading habit that is not aggressive. The stems do have a tendency to be floppy, which suggests using them for bank planting where this could be used create a cascading effect.

***Eurybia spectabilis* (syn. *Aster spectabilis*), showy aster.** The reasons to recommend this plant include its large flowers produced over a long period of time, nice fall and winter burgundy-colored foliage, insect and disease resistance, and rhizomatous habit that is not aggressive. Its chief problem is its stems, which tend to splay open rather than remaining upright.

#### ADDITIONAL READING

- Armitage, A.M. 1997. Herbaceous perennial plants. Stipes Pub., Champaign, Illinois.
- Jones, S.B., and L. Foote. 1990. Gardening with native wild flowers. Timber Press, Portland, Oregon.
- Hawke, R. 2002. Plant evaluation at the Chicago Botanic Garden. Perennial Plants, Autumn, 2002.
- Picton, P. 1999. The gardener's guide to growing asters. Timber Press, Portland, Oregon.
- Rickett, H.W. 1967. Wild flowers of the United States, McGraw-Hill, New York.

---

## Utilization of Global Assets for the Production of Nursery Products<sup>®</sup>

David B Kirwan

Foremostco, Inc., 8457 NW 66th Street, Miami, Florida 33166 U.S.A.

#### INTRODUCTION OF FOREMOSTCO, INC.

Foremostco, Inc (FMSTCO) is a leading grower/distributor of ornamental plants, annuals, perennials, foliage, and landscape material to the floriculture industry. Currently importing 20% of all plants brought into the country.

FMSTCO provides a steady supply and wide array of year-round availability of cuttings (rooted and unrooted), vegetative and tissue cultured liners, air-layered plants, seeds, bulbs, canes, and rhizomes.

FMSTCO has an organized sourcing network throughout Malaysia, Thailand, China, Taiwan, Costa Rica, Guatemala, Honduras, El Salvador, Nicaragua, Mexico, Brazil, Israel, South Africa, Ireland, United Kingdom, Denmark, Holland, Germany, Belgium, New Zealand, Australia, as well as Canada and the U.S.A.

FMSTCO directly employs 200 people with another 2300 directly associated to the operations that provide products to the company, utilizing about 5000 acres of production area.

FMSTCO maintains an automated, around-the-clock logistics department, which provides rapid in-house expediting of shipments, U.S.A. customs-certified staff that handles the customs processes, and U.S.D.A. clearance.

foliage, rich flower color, vigor, attractive low mounding habit with or without pinching, branches that do not splay open, and almost complete flower coverage

***Eurybia hemispherica* (syn. *Aster paludosus* subsp. *hemisphericus*), prairie wood aster.** This plant is recommended because of its very attractive flower color, pleasing and unusual foliage texture, relatively clean foliage, and spreading habit that is not aggressive. The stems do have a tendency to be floppy, which suggests using them for bank planting where this could be used create a cascading effect.

***Eurybia spectabilis* (syn. *Aster spectabilis*), showy aster.** The reasons to recommend this plant include its large flowers produced over a long period of time, nice fall and winter burgundy-colored foliage, insect and disease resistance, and rhizomatous habit that is not aggressive. Its chief problem is its stems, which tend to splay open rather than remaining upright.

#### ADDITIONAL READING

- Armitage, A.M. 1997. Herbaceous perennial plants. Stipes Pub., Champaign, Illinois.
- Jones, S.B., and L. Foote. 1990. Gardening with native wild flowers. Timber Press, Portland, Oregon.
- Hawke, R. 2002. Plant evaluation at the Chicago Botanic Garden. Perennial Plants, Autumn, 2002.
- Picton, P. 1999. The gardener's guide to growing asters. Timber Press, Portland, Oregon.
- Rickett, H.W. 1967. Wild flowers of the United States, McGraw-Hill, New York.

---

## Utilization of Global Assets for the Production of Nursery Products<sup>®</sup>

David B Kirwan

Foremostco, Inc., 8457 NW 66th Street, Miami, Florida 33166 U.S.A.

#### INTRODUCTION OF FOREMOSTCO, INC.

Foremostco, Inc (FMSTCO) is a leading grower/distributor of ornamental plants, annuals, perennials, foliage, and landscape material to the floriculture industry. Currently importing 20% of all plants brought into the country.

FMSTCO provides a steady supply and wide array of year-round availability of cuttings (rooted and unrooted), vegetative and tissue cultured liners, air-layered plants, seeds, bulbs, canes, and rhizomes.

FMSTCO has an organized sourcing network throughout Malaysia, Thailand, China, Taiwan, Costa Rica, Guatemala, Honduras, El Salvador, Nicaragua, Mexico, Brazil, Israel, South Africa, Ireland, United Kingdom, Denmark, Holland, Germany, Belgium, New Zealand, Australia, as well as Canada and the U.S.A.

FMSTCO directly employs 200 people with another 2300 directly associated to the operations that provide products to the company, utilizing about 5000 acres of production area.

FMSTCO maintains an automated, around-the-clock logistics department, which provides rapid in-house expediting of shipments, U.S.A. customs-certified staff that handles the customs processes, and U.S.D.A. clearance.

### Why Do We Do This?

- Quality
- Reliability
- Cost

### HOW THIS CAN BE ACCOMPLISHED

#### Breeding and Genetics.

- **Private Companies/Individual Breeders.** In house research and development departments continue to make seed crosses, complete trials, and market testing before distribution of product. We have done our best to support their efforts and work exclusively with breeders allowing us to maximize their investments by collecting royalties and providing distribution to growers.
- **University Programs.** As with private companies we are able to return royalty fees back to research departments both in the U.S.A. and worldwide to further research.
- **Localized Plant Markets.** Mom-and-Pop small businesses selling their products. In most cases these products are only available in “local” markets. Our ability to plug into this system allows us to obtain remote genetic material and promote to our customers.
- **Nature and Conservancy Groups.** As new species are found and later made commercially viable we are able to obtain rare or endangered species, produce with agreements and eventually fund more projects with returning royalties. We must pay attention to all governmental regulations, U.S.A. and others, as well as being mindful of CITES agreements.
- **Trade Shows and Auctions.** Available in regional markets. With a more organized system we are able to develop long-term relationships and in turn allows us to obtain commercially produced genetic material and quickly get it into the hands of our customers.
- **Remote Exploration for New Genetics.** Occasional and deliberate exploration of habitats, with permission allows us to locate some new genetics.

### TECHNOLOGY

#### Modern High Technology

- **Computerization:** The ability to duplicate repeatable growing protocols to provide the most efficient methods for production.
- **Computerization and Mechanical Automation:** The ability to move stock plants to a central processing area for making cuttings improves efficiencies and quality and enables some companies to produce products in a perfect greenhouse environment that may not necessarily be located in an ideal country. Denmark production — high labor costs — poor outdoor conditions can be overcome with the additional on environmental controls in the greenhouses and labor saving machines.
- **Tissue Culture Laboratories:** Allows for rapid, sterile, and homogenous products to be produced. Labor-intensive products can



be grown in relatively cheaper labor markets allowing competitive pricing.

**Low Technology.** Using good sanitation practices but smart low-tech methods to achieve.

- **Concrete Floors.** These reduce disease pressure, improve the working environment, and increase repeatable quality.
- **Foot baths/double door entry.** Slow the transmission of disease and insect problems keeping stock materials free from viruses ultimately improving quality.
- **Thrips Screens.** In general for virus-sensitive crops this is very effective in insuring proper insect controls.
- **Cultural Practices.** Washing of hands, wearing of gloves, and suits limit the exposure to potential problems.

## LABOR

- **Costs** — in high-cost countries — the employees are more skilled but with higher pay. These higher labor costs can be offset by automation. Bulky stock production that requires large production areas to produce products must be grown in areas where labor costs are lower. Typically these workers are not school educated but very well trained in the work skills that are required to complete their tasks.
- **Availability** – of labor even in Central America and Mexico is a challenge. As middle class jobs are available workers tend to avoid the rigors of nursery work. Selections of towns/villages and countries are very important. An operation with a small labor pool will struggle to meet the peak demands of shipping
- **Quality** – Desire to do a good job is important for choosing an effective work staff. We look to work with companies who value their employees, pay a good wage, offer training and contain a “can-do spirit.”

**Utilizing Localized Microclimates: Usable Sunlight, Temperature, Humidity, and Day Length.** We attempt to match conditions best suited for a particular crop. The tropics have many microclimates. The coastal areas are typically hot and moist, which is excellent for tropical ornamentals but disastrous for cool weather dry climate crops. Many of the Central American countries have mountain ranges that create microclimates. We are able to locate growing areas in isolated valleys or at high or low altitudes. A cool, dry area to grow *Hedera* ivy is perfect, while cool, wet climates to grow other items such as ferns are best. Typically governmental data is limited, and we rely on locals to give us input on the local weather conditions. We will also review the local flora and fauna, which is usually the best indicator of climate. We are able to modify climate somewhat by shade houses and greenhouses. This affords us additional controls for periods of excessive rains or droughts. Light levels are critical to determine the optimum growing conditions. If we have perfect temperatures and rain, low light levels will prevent good production.

---

## SEASONALITY

- Tropics
- Temperate climates
- Northern versus Southern Hemisphere
  - Seed production
  - Growing and dormant crops

Typically stock plants will produce at high levels when the cutting material is needed the least. For this reason we look to the opposite hemispheres on many of the products that we grow. If peak usage of cuttings is in the spring we can some times tailor-make the stock to produce high yields when they are needed the most. Seed production from South America is opposite North America. We are therefore able to utilize fresh seed year round, thus improving our yields, consistency, quality, and dependability.

## TRANSPORT LOGISTICS

- Temperature-controlled post-harvest using precoolers, temperature controlled trucks.
- Airlines for quick transport.
- Working closely with U.S.D.A. to meet all requirements.
- Live computer control for shipment status.

---

## ***Epimedium: Back to Basics***®

### **Anthony Eversmier**

7838 Babikow Road, Baltimore, Maryland 21237 U.S.A.

## INTRODUCTION

Propagating a new plant is just as challenging as remembering how to produce more familiar plants on a daily schedule. When learning a new plant, I try to keep the concept basic and true to how the plant grows in nature.

In Spring 1995 we started growing *Epimedium*. It was not until 1996 that we started experimenting with the idea of propagation. Early production of 1-qt material was purchased in from an outside source and potted for final sale. We decided to try propagation as a means of reducing price and servicing our customer with a better quality product.

Early propagation was successful by division, but the total yields were low and the cultivars were few. We needed a project for our winter propagation schedule, and *Epimedium* was just the kind of project that could fill a greenhouse in a 2-week timeframe. Propagation and production usually occurs in late November just prior to our *Anemone* and *Astilbe* crop production in early December.

Our experimenting over the years has given us insight into which cultivars grow the best in our Mid-Atlantic location. In response to our success, landscapers have been purchasing *Epimedium* selections that will flourish and perform for many years to come in the Mid-Atlantic region.

Wholesale suppliers are very important to achieving our production goals. Quality fresh bare-root plants definitely make the best propagation material. Setting the

---

## SEASONALITY

- Tropics
- Temperate climates
- Northern versus Southern Hemisphere
  - Seed production
  - Growing and dormant crops

Typically stock plants will produce at high levels when the cutting material is needed the least. For this reason we look to the opposite hemispheres on many of the products that we grow. If peak usage of cuttings is in the spring we can some times tailor-make the stock to produce high yields when they are needed the most. Seed production from South America is opposite North America. We are therefore able to utilize fresh seed year round, thus improving our yields, consistency, quality, and dependability.

## TRANSPORT LOGISTICS

- Temperature-controlled post-harvest using precoolers, temperature controlled trucks.
- Airlines for quick transport.
- Working closely with U.S.D.A. to meet all requirements.
- Live computer control for shipment status.

---

## ***Epimedium: Back to Basics***®

### **Anthony Eversmier**

7838 Babikow Road, Baltimore, Maryland 21237 U.S.A.

## INTRODUCTION

Propagating a new plant is just as challenging as remembering how to produce more familiar plants on a daily schedule. When learning a new plant, I try to keep the concept basic and true to how the plant grows in nature.

In Spring 1995 we started growing *Epimedium*. It was not until 1996 that we started experimenting with the idea of propagation. Early production of 1-qt material was purchased in from an outside source and potted for final sale. We decided to try propagation as a means of reducing price and servicing our customer with a better quality product.

Early propagation was successful by division, but the total yields were low and the cultivars were few. We needed a project for our winter propagation schedule, and *Epimedium* was just the kind of project that could fill a greenhouse in a 2-week timeframe. Propagation and production usually occurs in late November just prior to our *Anemone* and *Astilbe* crop production in early December.

Our experimenting over the years has given us insight into which cultivars grow the best in our Mid-Atlantic location. In response to our success, landscapers have been purchasing *Epimedium* selections that will flourish and perform for many years to come in the Mid-Atlantic region.

Wholesale suppliers are very important to achieving our production goals. Quality fresh bare-root plants definitely make the best propagation material. Setting the

product arrival date is also important; our goal is late November. When the plants arrive, we count all material and immediately place the product in our cold storage unit. We hold the plant material at 38 °F until we start production.

Processing begins as soon as possible. We work on one selection at a time. The plants are unpacked in our production area, rinsed twice to rehydrate and remove the excess peat moss, and placed in crates to drain.

Epimediums are easy to divide when you know the cultivars. Here are some of my notes for identifying each taxon.

- 1) *Epimedium grandiflorum*. Pale green leaves, white flowers, tight division, 5 to 10 per clump, compact vigorous growth, May.
- 2) *Epimedium grandiflorum* 'Lilafee'. Dark green leaves, lavender flowers, tight division, 5 to 10 per clump, compact vigorous growth. May.
- 3) *Epimedium rubrum*. Small heart-shaped leaves trimmed in red, rose-red flowers, tight division, 3 to 8 per clump. Compact vigorous growth, May.
- 4) *Epimedium* × *perralchicum* 'Frohnleiten'. Red foliage, yellow flowers, loose divisions 2 to 5 per clump, slow growth. May.
- 5) *Epimedium* × *versicolor* 'Sulphureum'. Large robust division, soft yellow flowers pale green foliage, 3 to 5 divisions per clump, vigorous growth, May.
- 6) *Epimedium* × *youngianum* 'Niveum'. True green leaves, white flowers, tight division 3 to 8 per clump, compact vigorous growth, May.

## PRODUCTION

The following planning and plants' portions I use as a checklist for the production crew.

### Planning.

- Ordering takes place in July, 500 to 700 of each.
- Choosing the most vigorous and reliable taxa is very important.
- Shipments are due to arrive in late November and early December.
- Set aside at least 2,000 ft<sup>2</sup> of greenhouse space.
- New cell pack materials on hand, 72's and 128's.
- At least 80 3-ft<sup>3</sup> bags of Sunshine LP5 mix will be needed.
- Prepare last year's records for yield comparison.
- Confirm if liquid shade is in stock at the nursery.
- Call broker 2 weeks in advance and confirm the arrival date of the stock plants.

### Plants.

- Receive plants, late November or early December.
- Immediately place in cold storage.
- Inventory boxes.
- Gather labels.
- Select first plant.
- Unpack as soon as possible.
- Rinse with water to rehydrate.
- Place into crates for processing.

- Gather proper tools.
- Refresh crew's memory on proper techniques and handling of plant material.
- Divide.
- Trim roots to fit into the cell (leave as much root as possible for plant health).
- Size and separate divisions.
- Rinse and cover till transplanting.
- Transplant into 72's and 128's.
- Cover with at least 2 inches of soil and as much as 4 inches of soil to protect all woody tissue and eyes of the plant.
- Place in a cool greenhouse, nights 38 °F and days 52 °F.
- Stock plant order minimum is 500, depends on availability.
- Each crop yield is at least 5,000 cells. This depends on the stock received.
- Every part of the plant is used; depending on the selection even the small eyes are placed in 128's (such as 'Lilafee' and 'Niveum').

### **Production.**

- Total production usually takes 2 weeks with an average of three people working.
- Labels should be stored under the cell pack and colored labels used to identify each separate plant type.
- Gradually allow the greenhouse to warm up with the outside temperatures.
- Airflow and ventilation is very important.
- First application of shade is the last week in March, depending on the weather.
- New foliage usually occurs 2 weeks after the first crop has been finished.
- Allow for even drying of soil and spot water depending on the weather.
- Maintain a layer of shade on the house as the days increase in length and temperature. Cool soil temperature is very important.
- First application of feed usually occurs at the end of March (9N-45P-15K at 90 ppm).
- One application of Clearly's 336 to prevent disease.
- Final application of feed occurs mid April (21N-8P-18K at 120 ppm).
- First plant out of crops occurs in mid May.

## Update on Micropropagation of Trillium Taxa

**S.L. Kitto, David Opalka, and Jesse Sinanan**

Department of Plant and Soil Sciences, University of Delaware, 531 S. College Ave., Newark, Delaware 19716-2170 U.S.A.

Our laboratory works on the development of micropropagation protocols for trilliums with the objective of making superior cultivars available to the gardening public. Superior trillium cultivars can have unique flower color, double flowers, or special leaf variegation or be fast multipliers. We can establish trilliums in culture from vegetative material. We can proliferate the rhizomes in culture and produce thousands of rhizomes in a much shorter time frame than under field conditions. The current stumbling block appears to be physiological and centered on the in vitro-proliferated trillium mini-rhizomes. We will report on three recent areas of research: (1) refinement of the surface disinfection protocols, (2) visualization of mini-rhizome initiation and proliferation, and (3) qualification of carbohydrate reserves within in vitro-generated rhizomes with respect to in vitro and ex vitro treatments.

### FRACTIONAL DISINFESTATION

A new protocol for surface disinfecting plant material has improved the ease with which we have been able to establish trilliums in vitro. This protocol was developed by Dr. Alice Waegel, a microbiologist, who worked in the laboratory fall 2001. We have refined this protocol, which involves placing the plant material in a medium that will encourage the germination and growth of the microbial contaminants for 4 h followed by a 10 min 10% bleach treatment and three 10 min water rinses. This cycle of vegetative microbial growth followed by a bleaching death can be repeated any number of times and has greatly facilitated our work with trilliums. We now know that we can expect high rates of clean up, which is important with plants that commonly have only small amounts of plant tissue available. Using this protocol we have been able to establish the double white *T. grandiflorum* 'Flore Pleno' in vitro.

### VISUALIZATION OF PROLIFERATION IN VITRO

We wanted to document what happened to a mini-rhizome during culture. Trillium rhizomes proliferate slowly and, it seems, randomly in vitro. We can culture a singlet mini-rhizome and weeks later we have proliferative masses containing rhizomes of many different sizes. But how does it happen? When are secondary mini-rhizomes generated and where do they come from? We chose to study this proliferation phenomenon using *Trillium maculatum*, a relatively fast proliferator in vitro. Five singlet mini-rhizomes were individually cultured in Magenta G-5 boxes containing trillium proliferation medium. Rhizomes were then photographed one or two times a week for 15 weeks. Care was taken during monthly subcultures to maintain the identical orientation. The "movie" created from these photos using Microsoft Producer for PowerPoint 2003 demonstrated that *T. maculatum* rhizome growth in vitro is dynamic and cyclic, as green leaves turned brown, new mini-rhizomes were generated within the axils.

### CARBOHYDRATE RESERVES IN TRILLIUM RHIZOMES

We had been chilling rhizomes prior to field establishment based on personal experience and the literature. Trillium and close relatives require a cold treatment either

of the seed for germination or (for lack of a better phrase) for maturation of the rhizome prior to flowering. We were looking for a treatment regime that would “trick” the *in vitro* trillium rhizomes. We were searching for a cold-warm cycling regime that the rhizomes could be subjected to that would result in “mature” rhizomes that would be ready to flower once planted/potted out. We had been chilling (4 °C) the rhizomes for 10 to 12 weeks and were having very little success with establishing the rhizomes. We cut a rhizome that had been chilled for 10 weeks, stained it with iodine to visualize the presence of starch, and to our surprise there was very little stain response. An experiment was set up to examine starch level in rhizomes over time. Rhizomes that had been either cold treated (4 °C) or warm treated (greenhouse) were harvested weekly and stained with iodine to visualize starch. While the iodine staining was very crude, making it difficult to draw any but the grossest conclusions, it appeared that the *in vitro* rhizomes contained starch but that the starch dissipated over an 8-week cold or warm treatment post culture.

---

## Judge Them by Their Appearance: Trialing Landscape Shrubs at Longwood Gardens

**Debbie Metrustry**

Longwood Gardens, PO Box 501, Kennett Square, Pennsylvania 19348 U.S.A.

### GENERAL INTRODUCTION

The shrub trials at Longwood Gardens were started in 1997 with the objective to provide information to the industry and amateur growers alike on what happens to a plant *after* it leaves the nursery — in other words, to answer the question: “how well does it do in a typical landscape situation?” The difference between our trials and others, and our strength as we see it, is that as well as being conducted over a long period of time, we use a great range of people to evaluate these plants. Our evaluators include students, staff, and volunteers, who between them demonstrate a variety of horticultural expertise and experience: they are our representative sample of the general gardening public. This makes for a reliable and exciting long-term study.

### HISTORY

The construction of the site for the plant trials began in 1996 with the selection of four sites, designated fields A–D, comprising nearly 7 acres in the nursery area of the gardens. The fields were not tilled, grass was eliminated by herbicides to make the planting beds, and 3–4 inches of mulch were added. Planting began shortly afterwards, in 1997.

Each field was divided into numbered rows of planting beds 12 ft wide separated by 8-ft grass strips. A brass tag mounted on a fiberglass stake every 10 ft along the row indicates distance from the beginning of the row and an additional sign marks every 50 ft. Each shrub is assigned a specific location and a location number, which makes navigation in the fields logical and straightforward.

It had been decided that a large proportion of the plants would be commonly used and commercially available, a good number would be commercially available but less widely used, and a small proportion would originate from wild-collected seed, seed exchanges with other botanical gardens world-wide, or other noncom-



of the seed for germination or (for lack of a better phrase) for maturation of the rhizome prior to flowering. We were looking for a treatment regime that would “trick” the *in vitro* trillium rhizomes. We were searching for a cold-warm cycling regime that the rhizomes could be subjected to that would result in “mature” rhizomes that would be ready to flower once planted/potted out. We had been chilling (4 °C) the rhizomes for 10 to 12 weeks and were having very little success with establishing the rhizomes. We cut a rhizome that had been chilled for 10 weeks, stained it with iodine to visualize the presence of starch, and to our surprise there was very little stain response. An experiment was set up to examine starch level in rhizomes over time. Rhizomes that had been either cold treated (4 °C) or warm treated (greenhouse) were harvested weekly and stained with iodine to visualize starch. While the iodine staining was very crude, making it difficult to draw any but the grossest conclusions, it appeared that the *in vitro* rhizomes contained starch but that the starch dissipated over an 8-week cold or warm treatment post culture.

---

## Judge Them by Their Appearance: Trialing Landscape Shrubs at Longwood Gardens

**Debbie Metrustry**

Longwood Gardens, PO Box 501, Kennett Square, Pennsylvania 19348 U.S.A.

### GENERAL INTRODUCTION

The shrub trials at Longwood Gardens were started in 1997 with the objective to provide information to the industry and amateur growers alike on what happens to a plant *after* it leaves the nursery — in other words, to answer the question: “how well does it do in a typical landscape situation?” The difference between our trials and others, and our strength as we see it, is that as well as being conducted over a long period of time, we use a great range of people to evaluate these plants. Our evaluators include students, staff, and volunteers, who between them demonstrate a variety of horticultural expertise and experience: they are our representative sample of the general gardening public. This makes for a reliable and exciting long-term study.

### HISTORY

The construction of the site for the plant trials began in 1996 with the selection of four sites, designated fields A–D, comprising nearly 7 acres in the nursery area of the gardens. The fields were not tilled, grass was eliminated by herbicides to make the planting beds, and 3–4 inches of mulch were added. Planting began shortly afterwards, in 1997.

Each field was divided into numbered rows of planting beds 12 ft wide separated by 8-ft grass strips. A brass tag mounted on a fiberglass stake every 10 ft along the row indicates distance from the beginning of the row and an additional sign marks every 50 ft. Each shrub is assigned a specific location and a location number, which makes navigation in the fields logical and straightforward.

It had been decided that a large proportion of the plants would be commonly used and commercially available, a good number would be commercially available but less widely used, and a small proportion would originate from wild-collected seed, seed exchanges with other botanical gardens world-wide, or other noncom-

**Table 1.** Genera with more than 20 taxa per genus.

Genus	Taxa (no.)
<i>Ilex</i>	117
<i>Viburnum</i>	110
<i>Buddleja</i>	79
<i>Spiraea</i>	75
<i>Syringa</i>	66
<i>Berberis</i>	51
<i>Hydrangea</i>	46
<i>Cornus</i>	40
<i>Hypericum</i>	40
<i>Deutzia</i>	39
<i>Philadelphus</i>	38
<i>Prunus</i>	38
<i>Forsythia</i>	36
<i>Potentilla</i>	29
<i>Sambucus</i>	28
<i>Cotoneaster</i>	23
<i>Callicarpa</i>	20
<i>Clethra</i>	20
<i>Vaccinium</i>	20

mercial sources. The commercial sources range from large landscape suppliers to small, specialist nurseries. Plants grown from seed were grown in the nursery for around 2 years before planting. Other plants bought in or donated by some of the larger nurseries were kept in the nursery until ready for planting.

There is a total head count of over 1300 taxa, and three specimens of each plant were installed. Only broad-leaved plants with potential ornamental qualities were included, and plants were spaced 4, 6, or 12 ft apart depending on the expected final spread of the mature shrub. In some instances plants were doubled on the row, providing north and south planting spaces for those that prefer north-facing conditions. Other than those in the north-facing spaces that have more shelter because of the double planting, all other shrubs must be happy in full sun to survive.

There are 100 genera in all, with 19 main groups of genera that have more than 20 taxa per genus (Table 1).

The establishment phase lasted for 2 years. During this time there were some losses due to a particularly hard winter; these were replaced, but after this phase further losses were no longer replaced

and any plants that died were deemed to have failed.

Since the point of the shrub trials is to test these plants for landscape use, the minimum of maintenance has been given, they have just had what would be expected in the typical landscape setting. They were irrigated, mulched, and weeded during the establishment phase, irrigation was discontinued after this, and mulching and weeding continue as necessary. Cut-back shrubs such as *Cornus* or *Vitex* are pruned annually. Shrubs that need thinning such as *Philadelphus* or *Deutzia* may have a third of the growth removed each year but aside from that, as a general rule, only winter-caused injury or diseased material is pruned. Pests and diseases are not controlled, but merely observed and recorded. As each genus is recorded and published it will be replaced with another so that the process can continue indefinitely.

## DATA COLLECTION

The establishment phase lasted for the first 2 years, and then the data collection began in 1999 to 2000. A computer database was developed in which the evaluators, now mostly students, record their observations under the following categories: size,

growth habit, stems, foliage, flowers, fruiting, overall rating, environmental injury, and pests, and pathogens. The date the information was recorded is always entered before their comments, and other information was pre-entered, such as plant name, location and accession number, source, and number of plants.

The evaluators are encouraged to compare plants with each other. They use an overall rating system that is intended to promote these comparisons but also provide an abstract and relative rating system, where (1) denotes an “unattractive” appearance, (2) denotes an “acceptable” appearance, (3) denotes an “attractive” appearance, (4) denotes a “very attractive” appearance, and (5) denotes the “best of class,” or most attractive plant in the group.

In the first instance, out in the field, the evaluators fill in a data sheet, and when they return to the office their data is transferred into the database. Students rotate through the department constantly, so the aim is to have them out in the field collecting data regularly, in order that a complete picture can be built up of each plant throughout the year. This data collection phase has continued to the present, and it now overlaps with the summary and publication phase of the trials.

## SUMMARY AND PUBLICATION

Once a substantial amount of information has been gathered on a particular genus, a report for each plant within that genus is electronically generated. This lists all the data that have been entered for that particular plant. At this point one of our volunteers takes over. She writes a one-page summary on each plant using the information in the report. The information from the summary is then used by the curatorial intern as part of her research for a paper on a particular genus or group of plants in the shrub trials, and a number of papers have been written and subsequently published by *The American Nurseryman*. Articles written and published so far presented results for *Berberis*, *Buddleja*, *Cornus*, and *Prunus*, with those for *Vitex* to be published soon. Each article focused on a different aspect of the plant group: for example, the articles on *Buddleja* concentrated on its flowering habits and seed production, while that on *Cornus* concentrated on stem color. In this way the results of the trials are given first to the industry and then to the public at large via the website.

Summaries of each plant in specific plant groups are also published on our website <[www.longwoodgardens.org/Plants&Horticulture/PlantEvaluationShrubTrials/Intro.htm](http://www.longwoodgardens.org/Plants&Horticulture/PlantEvaluationShrubTrials/Intro.htm)>. Shrub groups that have been summarized and published on the web include *Buddleja* and *Ilex verticillata*, with shrub dogwoods to be added shortly.

## CONCLUSION

The shrub trials here have generated much interest and have been successful in relating information to the industry as well as the general gardening public. Its strength is that while based on subjective experience and views of the evaluators, the results have an impartiality that is unlikely to be found in nursery catalogues and similar trade publications.

An experience of a plant is a complex thing: what appeals to one person may not appeal to another. However, tastes change over time and our group of evaluators will undoubtedly reflect the wider view. The results should therefore be useful to both the industry and the consumer, as the former need to know what is desired by the consumer, and the latter benefit from knowing which plants look best, and will do best for them in typical local conditions.

As a privileged link between the industry on the one hand and the study of plants on the other, Longwood is in an ideal position to mount this sort of study and will itself reflect and be guided by its discoveries, as well as sharing them with the horticultural and gardening world at large.

---

## Conifer Propagation®

**George Smith**

Blue Sterling Nursery, 372 Seeley-Cohansey Rd., Bridgeton, New Jersey 08302 U.S.A.

### INTRODUCTION

Propagation of rooted cuttings at Blue Sterling Nursery has always been a top priority both to ensure proper cultivar nomenclature and as a means to control quality. We have used many different methods and experimented many different ways. Out of the many factors to consider while propagating, timing and the space needed were definitely the biggest. The balancing of space available vs. amount needed always seemed to be an issue. Then there was the timing aspect to think about; plants all have a time when taking cuttings is most successful. And all of this is still somewhat based on actual demand or potential demand of that item years before it is saleable. With owners (Jim and Barb) always traveling across the globe searching for new and unusual plants, there always seemed to be more things added. It was very common to receive one 6-inch plant with the expectation of getting 500 cuttings ASAP because of the potential sales value. When talking about a dwarf cultivar it takes multiple cuts to even get 25 cuttings. Sometimes that meant we had to actively force certain plants to continually be able to get cutting wood. So needless to say we had to be very flexible both in timing and also space. While the propagation of most items was well within the proper time frame for great success, others were nowhere close. So like the rest of you, we always had to improvise. Mother Nature doesn't always like to be fooled, and you know how she can get.

### GOALS

- Ensuring proper nomenclature of each cutting.
- Achieving highest percentage of success on all cultivars.
- Provide top quality liners to production department.
- Doing all of above as efficiently as possible.

### EARLY FACILITY (CIRCA 1983–2000)

- 25 ft × 100 ft arched steel structure with two layers of clear poly.
- Raised benches separated into eight different zones each with controllable under bench heat.
- Each zone had separate misting capabilities controlled by electronic leaf devices.
- Cooling and venting was by two huge fans on the west end and shutters on east end.
- Two oil-fired hot air heaters connected with poly tube for better heat distribution.

As a privileged link between the industry on the one hand and the study of plants on the other, Longwood is in an ideal position to mount this sort of study and will itself reflect and be guided by its discoveries, as well as sharing them with the horticultural and gardening world at large.

---

## Conifer Propagation®

**George Smith**

Blue Sterling Nursery, 372 Seeley-Cohansey Rd., Bridgeton, New Jersey 08302 U.S.A.

### INTRODUCTION

Propagation of rooted cuttings at Blue Sterling Nursery has always been a top priority both to ensure proper cultivar nomenclature and as a means to control quality. We have used many different methods and experimented many different ways. Out of the many factors to consider while propagating, timing and the space needed were definitely the biggest. The balancing of space available vs. amount needed always seemed to be an issue. Then there was the timing aspect to think about; plants all have a time when taking cuttings is most successful. And all of this is still somewhat based on actual demand or potential demand of that item years before it is saleable. With owners (Jim and Barb) always traveling across the globe searching for new and unusual plants, there always seemed to be more things added. It was very common to receive one 6-inch plant with the expectation of getting 500 cuttings ASAP because of the potential sales value. When talking about a dwarf cultivar it takes multiple cuts to even get 25 cuttings. Sometimes that meant we had to actively force certain plants to continually be able to get cutting wood. So needless to say we had to be very flexible both in timing and also space. While the propagation of most items was well within the proper time frame for great success, others were nowhere close. So like the rest of you, we always had to improvise. Mother Nature doesn't always like to be fooled, and you know how she can get.

### GOALS

- Ensuring proper nomenclature of each cutting.
- Achieving highest percentage of success on all cultivars.
- Provide top quality liners to production department.
- Doing all of above as efficiently as possible.

### EARLY FACILITY (CIRCA 1983–2000)

- 25 ft × 100 ft arched steel structure with two layers of clear poly.
- Raised benches separated into eight different zones each with controllable under bench heat.
- Each zone had separate misting capabilities controlled by electronic leaf devices.
- Cooling and venting was by two huge fans on the west end and shutters on east end.
- Two oil-fired hot air heaters connected with poly tube for better heat distribution.

## MATERIALS

**Media.** Our propagation mix consisting of 4 peat moss : 40 bark : 2 sand to which is added  $\frac{1}{3}$  perlite for aeration.

**Flats.** 18 or 36 cell trays and 18 × 24 inch flats.

**Hormone.** Dip 'N Grow®.

**Fertilizers.** Peters 20-20-20 water-soluble and Nutricote 18-6-8 slow-release fertilizer.

## METHOD

The following is our method for rooting *Chamaecyparis obtusa*.

### Taking Cuttings.

- In the morning, estimated amount needed to complete daily totals.
- From proper location on plant.
- Placed into empty flats under constant mist within minutes of cutting.

### Preparation.

- Removal of lower branches by cutting close to stem to not damage cambium layer.
- Slight trimming of tops to even out crop.
- Light wounding if needed.

### Dipping in Hormone.

- Mixing appropriate concentration fresh daily.
- Assembling stems evenly by handful and dipping into solution for a few seconds.

**Sticking.** One per cell or 100 per flat depending on size.

**Labeling Each Tray or Flat.** Plant name, date stuck, hormone concentration used.

## MAINTENANCE OF ROOTED CUTTINGS

**Fungus/Pest Prevention.** Application of combination sprays every 7 to 10 days rotating chemicals to prevent resistance.

### Fertilizing of Rooted Cuttings.

- Applying liquid through injection with a rate of 50–100 ppm every 4th or 5th watering.
- Applying slow release at lowest rate to cell trays.

**Pruning.** Very light trimming to promote growth.

**Watering.** Hand watering as needed.

## RESULTS

- After 14 to 28 days callus tissue would start to form.
- After 6 to 8 weeks roots started to appear.
- At approximately 12 to 14 weeks light trimming occurred.
- At 18 weeks cuttings were ready to transplant to individual cells or to 1-gal containers to be hardened off before going to production.
- Labeling again occurred with strip labels for field use.

## Understock—Keys to Success®

**Brad Thompson**

Foxborough Nursery, Inc., 3611 Miller Road, Street, Maryland 21154 U.S.A.

### INTRODUCTION

There are three important parts to grafting. First would be the selection and quality of understock, this is the most important. Second would be the actual grafting and after care during the graft healing process. Third and final would be the first year of growing in its selected pot and growth environment.

### PLANT SPECIFICS

***Acer palmatum***. Starting with a plug understock liner in certain plant taxa gives us a better graft take and is more economical. *Acer palmatum* understock in a plug liner form gives us the best growth for grafting within 4 months of potting.

We do all of our bumping up the beginning of June of each year. The succession of growth is for the graft to be in its grafting pot for 4 to 8 months, then it will go into a 1-gal container for 1 full year and then into a 2-gal for 1 full year before going to the field. Our grafted maples are spaced in their flats for air circulation and light after grafting.

The cutleaf forms of *A. palmatum* are slower to form a full head, but they do maintain strong vigor and health.

***Carpinus betulus* 'Fastigiata'**. *Carpinus* also develop very well out of a 3-inch understock pot into a 1-gal container. We get very strong terminal growth in 4 months.

***Cedrus deodara***. We grow many cultivars of conifers, and our key to the success of our production is starting out with the best understock possible. *Cedrus deodara* is only available to us as a bare-root liner and not a plug liner. The problem that occurs with bare-root conifer seedlings is the inconsistency of the seedlings. They will vary greatly with height and caliper. It takes valuable time during the grafting season to go through these understocks and pick the best plants. This is a direct cost to us.

***Chamaecyparis nootkatensis***. *Chamaecyparis nootkatensis* cultivars (i.e. 'Strict Weeper') grow rapidly when potted into a 1-gal container.

***Cornus kousa***. *Cornus* and *Hamamelis* seedlings are more vigorous and therefore can be potted up as bare-root seedlings. They will make up and be ready in 4 months for summer grafting with excellent root development and top growth. Consideration must be given in controlling top growth when we have a cool, wet spring and early summer. The tops may need to be pruned back to increase caliper. It is our goal at grafting to match the scion and understock wood.

Though *Cornus* is available in a budded bare-root liner, it is still economical for us to graft it during the dormant season.

***Hamamelis virginiana***. Consideration must be given in controlling top growth when we have a cool, wet spring and early summer. The tops may need to be pruned back to increase caliper. It is our goal at grafting to match the scion and understock



wood. We will graft *Hamamelis* as a summer and also a winter graft. Summer grafts are under mist, and the winter grafts are waxed.

***Picea abies* and *Picea pungens*.** *Picea abies* plug liners give us a superior understock over the bare-root seedlings. Even though they may be different heights, they still maintain a closer caliper match and less variation in top growth.

Bare-root liners vary greatly in uniformity and root growth size. They require much time to root prune and prune the tops back to work in our pot system. With plug conifer liners we only need to pot them up. No root pruning and no top pruning needed. This makes for a faster growth start in the understock pot. Again the vigor and health of the plant is superior.

*Picea* and *Pinus* grafts respond better in their growth development when put into a growing condition of good drainage and air circulation. Mesh pots increase our survival rate in 1-gal containers.

*Picea pungens* cultivars are the slowest of the conifer group to develop. They take more care and attention. Our success ratio is greater with grafting onto a plug liner as compared to a bare-root liner. *Picea pungens* understock tops are left on the first season of growing in the 1-gal pot. They are removed the following early spring before new growth starts.

***Pinus strobus* and *Pinus flexilis*.** *Pinus strobus* is another conifer that shows a wide range of inconsistency with a bare-root seedling. Time is money, and when we can simply inject a plug into its pot and not waste time pruning, we save greatly. Our conifers are grafted December through February. The understock was potted in March of that year.

***Tsuga canadensis*.** *Tsuga* bare-root liners also range in size and may require us to hold on to the liner for an extra year. We find that caliper development can be very slow.

## Cutting Propagation of Large Leaf Rhododendrons and Deciduous Azaleas®

Henry "Hank" Schannen

RareFind Nursery, 957 Patterson Rd., Jackson, New Jersey 08527 U.S.A.

### BACKGROUND

RareFind Nursery is a specialty nursery in central New Jersey. Our customer base is internet mail order, retail at the nursery, and high-end landscapers. We carry over 2,000 plants, half of which are rhododendrons and azaleas. Propagating our own rhododendrons is a necessity, due to the fact that our list contains cultivars not available elsewhere. Many of our plants are being propagated for the first time; therefore there is no rooting track record, as there is for standards such as 'Roseum Elegans', 'Nova Zembla', and 'Catawbiense Album'. In fact we rarely sell these standards, which are easily rooted. We do purchase tissue culture plants, which account for perhaps 50 of the 1,000 or so rhododendron and azalea cultivars we typically stock. Therefore we must root our own, usually in smaller lots, for which we are often "flying blind" with little specific cultivar experience. In a given year we root approximately 10,000 rhododendrons, but we rotate our list of plants and limit it to about 500 cultivars per year. This is not a formula for efficiency!

### ROOTING LARGE-LEAF RHODODENDRON: ELEPIDOTES

- We typically start taking large-leaf rhododendrons on Aug. 1 and continue into November, refrigerating the cuttings in plastic bags for up to a week. Due to the large number of taxa we propagate, clearly marking each bag is important.
- All cuttings are taken off of this year's growth and are probably classified as semihardwood cuttings.
- Our preferred cutting wood is slender, in the 1/4-inch caliper range; however we will use heavier caliper material if the wood is scarce or if we are trying to swiftly increase the number of plants. Rooting success tends to decrease as the caliper increases.
- Successful rooting can also be dependant upon the age of the plant donating the wood. We see higher success rates from younger plants.
- The donor plants should be well watered, and the cuttings should be turgid. Cuttings are typically taken in the 4- to 5-inch range and cut back to 3 to 4 inches.
- Excess leaves are cut off until we have a rosette of 3 to 4; if the leaves are large, they will be trimmed back to half their normal length to reduce transpiration and to enhance air circulation.
- Using a box cutter, both sides of the cutting are wounded, slicing down to the cambium.
- A standard plastic tray (with drain holes) containing an 18-cell insert is prepared. The medium is 1 supercoarse perlite : 1 peat (v/v), pre-watered, but well drained.

- The rooting hormone we use is Dip 'N Gro® concentrate. We modify the dilution rate as the season progresses and the cuttings harden:

Month	Dilution Ratio
August	15:1 and 10:1
September	10:1 and 8:1
October	8:1
November	8:1 and 5:1

- As many cuttings as can be held are dipped in the hormone solution for 5 to 6 sec and then placed one to a cell in the plastic flat.
- The cuttings are watered in and placed under intermittent mist; in our case it is 5 to 6 sec on and 5 min off. This timing must be watched and adjusted depending upon the weather—especially on cloudy versus sunny days.
- Some of our benches are tented, and others only have plastic sides. We do not see differences between the two methods.
- Our large Lexan propagating house is run at 65 °F in fall and winter. Hot-water bottom heat is run at 70 °F.
- Rooting begins at 30 days, and feeding with ¼-strength liquid fertilizer begins at 45 days.
- As rooting progresses, the heavier rooted trays are moved to another heated house until spring when they are up potted into 300's. Liquid fertilization continues at half the normal rate. As they go outside, the full rate is applied.
- Overall success rates are generally in the 65% to 70% range, but individual cultivars can be highly variable. This rate is lower than what has been reported for standard cultivars, but given the untested cultivars we grow, we are not sure if the ratio can be improved.

## ROOTING DECIDUOUS AZALEAS

- Ninety five percent of the 120 deciduous azaleas we grow are American natives or native hybrids. There are 20 cultivars, which are in tissue culture, and the remainder is rooted cuttings. The basic rooting principles are the same for large-leaf rhododendrons and deciduous azaleas, but some of the details change:
- Deciduous azalea cuttings are taken in late May to early June. They are usually classified as softwood cuttings and are just hard enough to snap.
- Our rooting medium, the stripping of leaves, wounding techniques, misting and bench heating are the same, except more care needs to be taken due to the fragile nature of the softwood cuttings. Cuttings are stuck in 24 cell trays
- We use Dip 'N Gro in the following dilutions:
 

Month	Dilution ratio
May	20:1 and 15:1
June	15:1 and 10:1
- Rooting occurs in the 4 to 5 week range. One-quarter-strength liquid feeding begins at the 6-week level and gradually increases to half-strength until they are potted in 300's in spring.
- We do run extra lighting in the fall to force growth or bud swelling before they go into dormancy. We also apply more heat in the spring to encourage their breaking dormancy.

## Chip Budding Hard-to-Root Magnolias<sup>®</sup>

**Richard Hesselein**

Pleasant Run Nursery, Inc., P.O. Box 247, Allentown, New Jersey 08501 U.S.A.

For many years, magnolias have been one of my favorite groups of plants. Their glorious spring flowers, with a variety of shapes, colors, degrees of fragrance and bloom time, make them as a group some of spring's most magnificent flowering plants.

Not all magnolias are easy to propagate by cuttings. In fact, some have proven to be so difficult that the low percentage of success renders them virtually not economical to reproduce. At Pleasant Run Nursery, we propagate our magnolias by the method of chip budding. This has proven to be so successful that we rarely fall below a 90% bud take. Over the years, we have learned a few techniques, which have helped to keep our percentage of take consistently high.

In the spring, we purchase bare-root *Magnolia kobus* seedlings, which we immediately pot up in containers. We prefer to use *M. kobus* over *M. acuminata* because our bud take is significantly better with this species. The size of understock that we prefer is  $\frac{3}{16}$  inch or  $\frac{1}{4}$  inch in caliper; this ensures a proper size at the time of chip budding. We pot the understock in a 1.60-gal container (trade #2) in mid-March, using a medium-rate slow-release fertilizer. The understock is allowed to grow all summer, and by September it is ready for budding. The maturity of the budwood is what actually determines the start date of budding. What we look for are well-defined lenticels and the lack of really green wood. In New Jersey, this is usually from mid-September through early October.

Now that the understock and budwood are ready, the chip budding process can begin. The necessary tools include: a good quality grafting knife and medium-coarse sharpening stones, hand pruners, rubbing alcohol, clean rags, and  $\frac{1}{2}$ -inch white polyethylene budding tape. First we prepare the understock by removing all leaves and secondary stems 6–8 inches above the soil level in the container. The understock is then brushed gently with a clean rag to remove any remaining debris. Next the budwood is collected. We usually try to collect enough for 1 to 2 days of budding at a time. It is important to use only current year wood and to try to find wood that has many vegetative buds, not flower buds. Good budstocks will usually have between 5 to 20 buds. Remove the leaves with hand pruners by cutting the petiole  $\frac{1}{4}$  inch from where it attaches to the budstick. This is also a good time to cut off the green or unripened wood near the tip of the budstick. Tie up the prepared budsticks in bundles and be sure to label each bundle. These can then be wrapped in moist burlap and stored in a cool place or a refrigerator. (If taken care of properly, budwood can be stored under refrigeration for several weeks without harm.)

Preparation of the understock to receive the chip bud can now take place. Find a smooth and straight area on the understock 2 to 3 inches above the soil level. Take the sharpened grafting knife and make a  $\frac{1}{8}$ -inch-deep cut towards the base of the understock at an angle of about 20° to 30°, to form a small tab. Make a second cut about  $1\frac{1}{2}$  inches above the tab and  $\frac{1}{8}$  inches deep. Push the knife blade down while maintaining the depth of  $\frac{1}{8}$  inch until this cut meets the small tab. At this time the small piece of wood should fall off to expose the woody tissue and cambium.

The next step will be to remove from the budstick a bud chip, which must be the same shape and depth as the cut in the understock. To do this, hold the base of the

budstick towards you and make a  $\frac{1}{8}$  inch deep cut with an angle of  $20^\circ$  to  $30^\circ$  about  $\frac{1}{4}$  to  $\frac{1}{2}$  inch, below the scion bud. Make a second cut  $\frac{1}{8}$  inches deep approximately  $\frac{3}{4}$  inches above the scion bud. Draw the knife down behind the bud to form the small veneer. Hold the scion bud chip between your thumb and forefinger. Do not touch the cut surface in order to avoid contamination of the bud union. The bud chip can now be placed on the cut made in the understock. The tab on the understock should hold the bud in place long enough to be tied in. A good bud chip to understock match should show a very narrow margin of exposed cut surface on the understock, around the perimeter of the bud chip. Small supplemental cuts can be made in the understock and bud chip to ensure a good match. Use caution not to touch any cut surfaces.

The bud should be tied in as soon as possible after the carpentry is complete. Remove an 8 to 10 inch long piece of  $\frac{1}{2}$  inch white polyethylene budding tape from the roll. Stretch one end of the tape over and beyond the basal cut and, maintaining tension, begin tying the bud in. Each wrap around the understock should have an overlap, keeping the tension steady as you cover the chip. Magnolia buds are quite large and fragile, so avoid covering them with the budding tape. Keep the wraps tight enough that all cut surfaces are covered and only the scion bud is exposed. Continue to wrap  $\frac{1}{2}$  to 1 inch above the chip and tie off with a half-hitch knot.

If the temperature remains warm, the budding tape can be cut off in 4–6 weeks. Callus tissue should be visible around the entire cut in the understock and the leaf petiole should easily fall off. If the callus tissue is not well formed, rewrap the bud chip and inspect in another 7–10 days. Removing the ties too early will cause the bud chips to peel away from the understock. Leaving the ties on too long can cause the bud chip to rot or the callus tissue to grow over and cover the bud chip.

Overwintering the chip-budded understock requires some preparation and attention. By late November, all of our understock is set pot-to-pot in an overwintering house, which provides some minimal heat. We cover the house with 55% 3-mil, white overwintering poly, and only provide enough heat to keep the pots from freezing solid. We have found that magnolia roots can be damaged in an unheated house during a very cold winter. By the end of February the understock is ready to be cut back. Using a sharp pair of hand pruners, cut off the understock about  $\frac{1}{16}$  inch above the top of the chip bud. The cut can be flat, although we cut at about a  $30^\circ$  angle with the short side being on the back of the understock. This allows the bud to callus easily over the understock cut.

As the weather warms, the buds will begin to swell and eventually elongate. When the buds are about 1 to  $1\frac{1}{2}$  inches long we install Grow-Straights<sup>®</sup> (at this time we also rub off any understock buds, which may have begun to grow). J. Frank Schmidt and Son in Boring, Oregon, developed Grow-Straights. They are simply a piece of right-angled metal, pointed at one end so they can be more easily pushed into the soil. They are available in several lengths, and the 12-inch length works best for us. The Grow-Straights are pushed into the soil in front of the elongated bud, keeping the new growth inside the right angle. We find using Grow-Straights offers several advantages: they protect the bud from being blown off by the wind, they eliminate “dog-leg” (right angle) stems, and they reduce the need for staking certain cultivars. Our magnolias are ready for sale by mid May or the beginning of June the year after the understock is planted. Most cultivars are 2 to  $3\frac{1}{2}$  ft tall at

this time. Some of the faster-growing cultivars may need staking, but we find most stems are strong enough to support themselves without flopping.

Chip budding magnolias offer several advantages over other methods of propagation. As was stated earlier, many magnolia cultivars are difficult to root. Also, only one bud is needed to produce a finished plant, unlike propagation using cuttings or grafting. Finally, chip buds are much more vigorous than grafts during the 1st year of growth. This vigor will provide a more robust liner for growing on or a significantly larger plant for the home gardener.

---

## Correlation of Growing Degree Days and the Timing of Cuttings<sup>©</sup>

**H. William Barnes**

Lorax Farms LLC, Warrington, Pennsylvania 18976 U.S.A.

### INTRODUCTION

The proper timing for taking cuttings is essential for good propagation results. It is well known that some plants have very narrow time frames in which cuttings can be taken with any degree of success. Some obvious examples are *Euonymus alatus* and *Syringa vulgaris*; if the cutting wood is allowed to mature beyond a certain point, the percentage of rooted cuttings declines greatly. Alternatively, if cuttings of some plants are taken too early in the season, carbohydrates and essential cellular components are not in sufficient quantity to allow for good rooting. Therefore it is critical that the time frame for taking cuttings be watched closely. Violate the time frame, and deleterious results can be quickly found. For instance, *Scabiosa* and asters make two types of growth: one is strictly vegetative and the other gives rise to flowering. Cuttings taken of flowering shoots will often root, flower, and then die; they will not set the needed basal rosettes or buds that will bring the plant through as a perennial. One type of cutting essentially makes it an annual; the other type keeps the perennial characteristics intact.

This quest for the proper timing of cuttings for propagation depends heavily on a variety of tools for success. Calendars immediately come to mind but fall short of delivering consistent results. Weather conditions such as rain, drought, late frosts, early frosts, and a host of events that cannot be readily controlled have considerable influence. Calendars are useful as a starting place, but with many plants things have to be more quantitative. This technique has its drawbacks, though, in that plant development can vary from one year to the next as well as change based upon specific localities (Wunderground.com, 2005). Basing pesticide and chemical applications on a particular week of a calendar is not adequate. Orton and Green (1999) hit upon a good idea with their tome on correlating plant pests with the bloom time and other phenological expressions of plant growth. Their system worked by associating specific pests with specific activities of plants in a large area where it is known that a certain plant such as *Amelanchier canadensis* will bloom or leaf out at the same time period that a specific pest such as Gypsy moth begins to hatch. This technique goes back in time because *A. canadensis* is known as "shadbush" because it blooms at the same time that the shad (a fish) starts their annual migration up

this time. Some of the faster-growing cultivars may need staking, but we find most stems are strong enough to support themselves without flopping.

Chip budding magnolias offer several advantages over other methods of propagation. As was stated earlier, many magnolia cultivars are difficult to root. Also, only one bud is needed to produce a finished plant, unlike propagation using cuttings or grafting. Finally, chip buds are much more vigorous than grafts during the 1st year of growth. This vigor will provide a more robust liner for growing on or a significantly larger plant for the home gardener.

---

## Correlation of Growing Degree Days and the Timing of Cuttings<sup>©</sup>

**H. William Barnes**

Lorax Farms LLC, Warrington, Pennsylvania 18976 U.S.A.

### INTRODUCTION

The proper timing for taking cuttings is essential for good propagation results. It is well known that some plants have very narrow time frames in which cuttings can be taken with any degree of success. Some obvious examples are *Euonymus alatus* and *Syringa vulgaris*; if the cutting wood is allowed to mature beyond a certain point, the percentage of rooted cuttings declines greatly. Alternatively, if cuttings of some plants are taken too early in the season, carbohydrates and essential cellular components are not in sufficient quantity to allow for good rooting. Therefore it is critical that the time frame for taking cuttings be watched closely. Violate the time frame, and deleterious results can be quickly found. For instance, *Scabiosa* and asters make two types of growth: one is strictly vegetative and the other gives rise to flowering. Cuttings taken of flowering shoots will often root, flower, and then die; they will not set the needed basal rosettes or buds that will bring the plant through as a perennial. One type of cutting essentially makes it an annual; the other type keeps the perennial characteristics intact.

This quest for the proper timing of cuttings for propagation depends heavily on a variety of tools for success. Calendars immediately come to mind but fall short of delivering consistent results. Weather conditions such as rain, drought, late frosts, early frosts, and a host of events that cannot be readily controlled have considerable influence. Calendars are useful as a starting place, but with many plants things have to be more quantitative. This technique has its drawbacks, though, in that plant development can vary from one year to the next as well as change based upon specific localities (Wunderground.com, 2005). Basing pesticide and chemical applications on a particular week of a calendar is not adequate. Orton and Green (1999) hit upon a good idea with their tome on correlating plant pests with the bloom time and other phenological expressions of plant growth. Their system worked by associating specific pests with specific activities of plants in a large area where it is known that a certain plant such as *Amelanchier canadensis* will bloom or leaf out at the same time period that a specific pest such as Gypsy moth begins to hatch. This technique goes back in time because *A. canadensis* is known as "shadbush" because it blooms at the same time that the shad (a fish) starts their annual migration up



the rivers of the East Coast. Their technique has some application in plant propagation, but it is not precise and only gives a general approximation as to when to look for the proper cuttings.

Growing degree days (GDD) came along as a means of determining heat units during a given season. The heating and air conditioning industry has used it for years to determine energy requirements for any given time period. The agricultural industry tied onto the concept and applied it to agricultural crops such as corn and sugar beets for both the timing of crop harvest (Eckert, 2005; Holen and Dexter, 1996) and for insect and pest control measures (University of Massachusetts Extension, 2005; Wunderground.com, 2005). As a result of such work it did not take long for horticulturists to look at GDD for pest control measures and then at GDD as plant status indicators (Annenberg Media, 2001; Griffith and Nelson, 2000).

Specifically GDD is a means of establishing a cumulative measure of the heat units during a specific time period. Heat units are best and most simply determined by looking directly at temperature. Temperature (Holen and Dexter, 1996) is considered the main factor that influences the rates of plant growth, although others such as moisture levels, day length, and light qualities also have secondary affects. GDD is the simplest of a number of models predicting plant growth and development and GDD is versatile enough to be adapted to specific plants if the situation calls for it.

Growing degree days can be calculated by a variety of ways but 50/86 formula is the most common and easiest to implement (Pacific Northwest Co-Operative Agricultural Weather Network [Agrimet], 2005; University of Massachusetts Extension, 2005; Eckert, 2005) and is best illustrated by the formula: 50 °F is the base temperature, 86 °F is the upper limit.

**Example 1.** High temperature is 80 °F, low temperature is 60 °F, base temperature is selected to be 50 °F.

$$[(80 + 60)/2] - 50 = 5 \text{ GDD}$$

Adjustments are necessary when temperatures exceed 86 °F or fall below 50 °F. For instance, a high of 95 °F is converted to 86 °F because 86 °F is the upper limit. A low of 45 °F is used as 50 °F. If a negative number is encountered as a GDD it is regarded as 0 GDD (University of Massachusetts Extension, 2005).

**Example 2.** High temperature is 95 °F and the low is 75 °F, the GDD is calculated as  $[(86 + 75)/2] - 50 = 30.5$  rounded to nearest number of 31 GDD

Once a given date is selected as the starting point, then each GDD is added to the previous day's total number so that by the fall of the year it is not unusual to see accumulated GDDs or AGDD as 3000 or above.

The base numbers 86 and 50 are derived from the expectation that most plants in the Northeastern U.S.A. begin growth at an average of 50 °F and will generally grow well until temperatures start to exceed 86 °F. It is thought that temperatures past 86 °F do little to add to the growth rate, and in some cases growth rates may stall at 90 °F or better (Pacific Northwest Co-Operative Agricultural Weather Network [Agrimet], 2005; University of Massachusetts Extension, 2005; Wunder-

ground.com, 2005). The base lines can be tailored to meet specific plant requirements, for instance if someone is studying skunk cabbage (*Lysichiton americanus*) or tulips (Annenberg Media, 2001) then the lower base should be adjusted to 40 °F and the upper limit should perhaps be changed as well to a lower temperature such as 70 °F to be more applicable to the given plant. Spring ephemerals need special consideration, and the base temperatures can be lowered to 34 °F to compensate for their unique growth patterns (Orton and Greene, 1999).

Growing degree days can also be expressed in Centigrade temperature scales with base lines being adjusted to meet the centigrade equivalent, i.e., 10 °C and 30 °C being close approximations of the 50/86 settings (Natural Resources Canada, 2005).

The concept of GDD has been further integrated into the horticultural world where GDD is used to note differences in cultivars (University of Massachusetts Extension, 2005) and their bloom times with plants as varied as corn (Eckert, 2005) sugar beets (Orton and Greene, 1999), and fescue grasses (Griffith and Nelson, 2000). If seed set, nitrogen metabolism, leaf stage development, flowering, and similar phenological traits can be followed by GDD, then it seems realistic to think that something such as the propensity for rooting in cuttings can be deduced as well.

This study was implemented to test this hypothesis and make conclusions based upon three different woody plant species with three different rooting thresholds.

## METHODS

Three species of woody plants were selected to determine if GDD can be applied to the rooting of cuttings. Rooting proficiency ranged from easy to difficult, with *Hydrangea paniculata* 'Tardiva' being easiest, *Syringa josikaea* a moderate rooter, and *Magnolia* 'Betty' the most difficult. The experiment was started on 7 June and progressed to 19 July for the taking of cuttings and 20 Aug. for the evaluation of cuttings.

Cuttings were stuck under mist, 10 sec/10 min, in a greenhouse with supplemental bottom heat set at 70 °F. Cuttings were direct stuck in 2<sup>1</sup>/<sub>4</sub>-inch pots with a substrate of 1 Metromix 510 : 1 perlite (v/v). Hormone applications were consistent throughout the trial with Dip 'N Gro® at 1:15 dilution rate (600ppm IBA/300 ppm NAA) for *H. paniculata* 'Tardiva', 1:10 dilution rate (1000 ppm IBA/500 ppm NAA) for *S. josikaea*, and 0.8% IBA powder for *M. 'Betty'*. All cuttings except for *H. paniculata* 'Tardiva' were wounded.

Cutting rooting status was determined by pull and tug with visual inspection for root emersion from the bottom of the pot as a definitive marker.

Growing degree data was obtained via the Internet by a subscription service through Penn State Extension Service. Specific data was available from 10 to 12 sites depending upon those reporting for a given week. To concentrate the data, four sites were selected for a physical proximity to the test site. Those that were outside of a 12-air-mile radius were eliminated. The GDD was tabulated by taking an average of the four sites. Figures were included for base temperatures of 50, 47, 43, and 40 °F and a soil base temperature of 32 °F, listed respectively as B50, B47, B43, B40, and soil B32.

## RESULTS AND DISCUSSION

Table 1 shows data concerning cutting days to rooting, actual number rooted, and rooting percentages for all three species and collection and evaluation dates. Table

**Table 1.** Growing degree data for specific dates.

Date	Base temperature*				
	B50	B47	B43	B40	B32
6/07/05	757	935	1205	1435	2135
6/22/05	1062	1292	1626	1925	2739
6/24/05	1110	1340	1674	1973	2789
6/26/05	1152	1386	1728	2031	2861
7/13/05	1413	1698	2112	2448	3432
7/18/05	1553	1838	2252	2588	3572
7/19/05	1582	1867	2281	2617	3601
8/01/05	2168	2506	2990	3380	4501
8/20/05	2528	2954	3524	3977	5250

\* Base temperatures of 50, 47, 43, and 40 °F and a soil base temperature of 32 °F, listed respectively as B50, B47, B43, B40, and soil B32.

**Table 2.** Rooting of three taxa.

Species	Timing and removal data					
	Date stuck	Date removed	Total stuck	Days to rooting	Rooted (no.)	Rooted (%)
<i>Hydrangea paniculata</i> 'Tardiva'	06/07	06/22	32	15	30	94
	06/24	07/13	32	20	32	100
	07/19	08/01	32	14	32	100
<i>Syringa josikaea</i>	06/07	06/26	32	19	30	94
	06/24	07/18	32	25	28	88
	07/19	08/20	32	33	32	100
<i>Magnolia</i> 'Betty'	06/07	07/18	32	42	28	88
	06/24	08/01	32	39	15	47
	07/19	08/20	32	33*	1	3

\*Cuttings pulled due to leaf drop and overall death or rotting.

2 shows the rooting data for individual species responses with respect to the AGDD at the time of sticking. Table 3 shows a comparison of growing degree days (GDD), days to root, and rooting percentage. There were no significant differences in rooting percentages for either *H. paniculata* 'Tardiva' and *S. josikaea* with respect to an increasing AGDD. However, with the case of *S. josikaea*, there was a noticeable difference with respect to the total number of days it took the cuttings to root. With AGDD of 757, rooting time for *S. josikaea* was 19 days, which then increased to 25 days at 1110 AGDD and climbed again to 33 days for AGDD of 1582. This is sig-

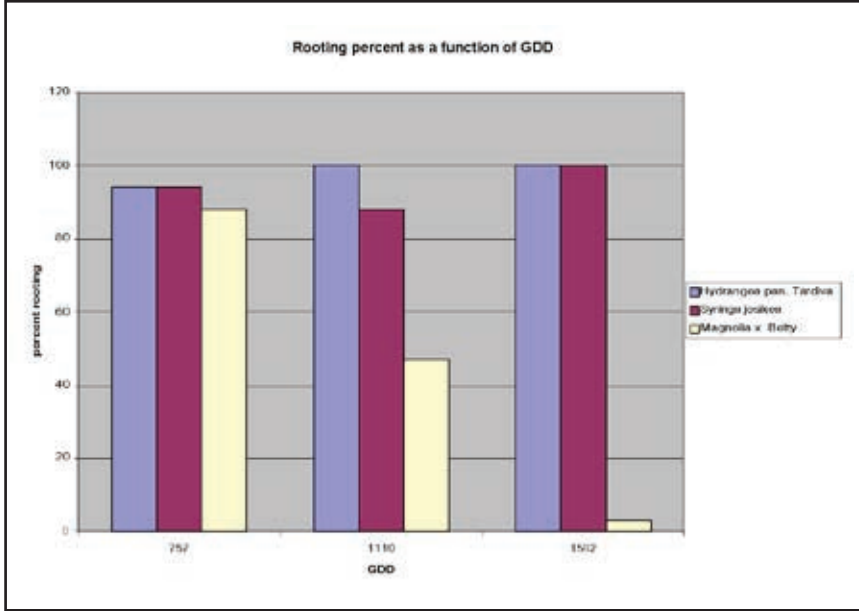


Figure 1. Rooting percentage as a function of growing degree-days.

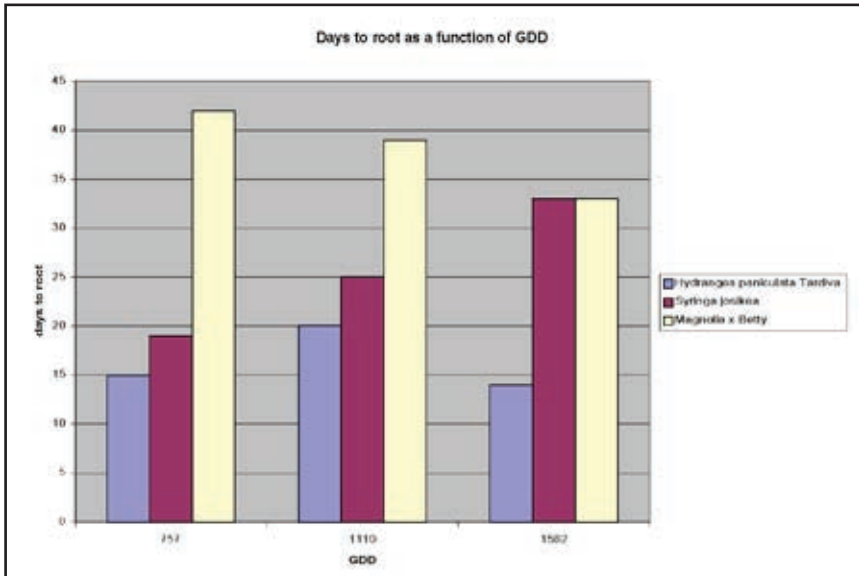


Figure 2. Days to root as a function of growing degree-days.

**Table 3.** Comparison of growing degree days (GDD), days to root, and rooting percentage.

06/07/05	GDD B50 (757)	Days to root	Rooting (%)
	<i>Hydrangea paniculata</i> 'Tardiva'	15	94
	<i>Syringa josikaea</i>	19	94
	<i>Magnolia</i> 'Betty'	42	88
06/24/05	GDD B50 (1110)		
	<i>Hydrangea paniculata</i> 'Tardiva'	20	100
	<i>Syringa josikaea</i>	25	88
	<i>Magnolia</i> 'Betty'	39	47
07/19/05	GDD B50 (1582)		
	<i>Hydrangea paniculata</i> 'Tardiva'	14	100
	<i>Syringa josikaea</i>	33	100
	<i>Magnolia</i> 'Betty'	33*	3

\* Leaf drop rendered cuttings inviable.

nificant because cuttings taken early on an AGDD of 757 rooted well and quickly, which is valuable because it increases the production potential over the course of time; i.e., the quicker cuttings root, the faster valuable greenhouse space becomes available again.

When *M.* 'Betty' is considered, number of days to root does not seem to be a factor; however, rooting percentages did change by decreasing with an increase in AGDD going from a high of 88% at AGDD of 757 and declining to 3% when taken with AGDD of 1582. The graphic representations of the decline in percentages as a function of AGDD can be readily seen in Fig. 1 and the change in rooting time can be seen in Fig. 2.

Some general conclusions can be drawn from this data. Number one is that using AGDD as a tool to determine rooting potential has merits, but it is not always needed and, with easy-to-root plants such as *H. paniculata* 'Tardiva', the time for data gathering and processing has little value unless extended far into the fall of the year to determine exactly when cuttings can no longer be taken with any degree of success. With respect to plants that root well it is surprising to see that an AGDD can detect changes in rooting responses based upon the number of days it takes to achieve a satisfactorily rooted cutting. In these cases an AGDD might be warranted to establish a protocol for future reference that could be used for scheduling particular plants so that those that have been shown to root slowly with advancing AGDD can be stuck earlier and those that show no response can be stuck later in the summer season. For instance, for a limited propagation space it would be better to stick the *S. josikaea* first, obtain a good crop, and then stick the *H. paniculata* 'Tardiva', thereby maximizing potential rooting space. AGDD can be used to detect declines in rooting response in more difficult to root plants, such as was found in *M.* 'Betty'. It is clear that cuttings of that plant taken at an AGDD of 757 performed well, while those taken at an AGDD of 1582 were woefully inadequate.

A practical suggestion would be to examine particular cutting profiles and isolate those plants that normally root poorly or slowly. Looking at them specifically with

a critical study such as AGDD can establish a base line of when to take these cuttings for maximum results. Ideally an AGDD study should be carried out for 2 or 3 years to compensate for the vicissitudes of climate variation. But, once a thorough history has been compiled for a particular difficult-to-root plant the resultant data can serve as a readily available reference. Knowing that a plant like *M. 'Betty'* roots best around when the AGDD is 757 could prove to be invaluable for the production of that plant on a profitable basis. Many plants have very short time frames for successful cutting propagation, and a program based upon an AGDD study with very narrow variations of AGDD such as 10% might prove to be useful for clearly identifying a start and stop time.

### LITERATURE CITED

- Annenberg Media.** 2001. Journey north. Annenberg Media, Learner.org. <[www.learner.org/jnorth/TM/tulips/GDD.html](http://www.learner.org/jnorth/TM/tulips/GDD.html)>.
- Eckert, D.J.** 2005. Growing degree days as a method of rating the maturity of corn hybrids. AGF-101-90. The Ohio State Extension, Agronomy Facts <[www.ohioline.osu.edu/Agf-fact/0101.html](http://www.ohioline.osu.edu/Agf-fact/0101.html)>.
- Griffith, S.M., and M.A. Nelson.** 2000. Tall and fine fescue: Relationships between growing degree days, developmental stage and nitrogen acquisition. 2000 Seed Production Research. Oregon State University, USDA-ARS Cooperating.
- Groneborg, S.** 2004. Explanation of growing degree days. <[www.MRSARS.USDA.gov/morris/weather/gdd.htm](http://www.MRSARS.USDA.gov/morris/weather/gdd.htm)>.
- Holen, C.D., and A.G. Dexter.** 1996. A growing degree day equation for early sugar beet leaf stages. Sugarbeet Research and Extension Reports. 29:152-157. University of Minnesota.
- Natural Resources Canada.** Accessed 2005. Growing degree days: The atlas of Canada. <<http://atlas.gc.ca/site/english/maps/archives/5thedition/environment/climate/mcr4034>>.
- Orton D.A., and T.L. Greene.** 1999. Coincide: The Orton system of pest management. Plantsman Pub., Flossmoor, Illinois.
- Pacific Northwest Co-Operative Agricultural Weather Network (Agrimet), The.** Accessed 2005. Agrimet growing degree days algorithm. <[www.usbr.gov/pn/agrimet/gdd.html](http://www.usbr.gov/pn/agrimet/gdd.html)>.
- University of Massachusetts Extension.** Accessed 2005. Integrated pest management tools; Monitoring: Growing degree days and plant phenology. <[http://www.umass-greeninfo.org/fact\\_sheets/ipmtools/gdd\\_phenology.html](http://www.umass-greeninfo.org/fact_sheets/ipmtools/gdd_phenology.html)>.
- Wikipedia, The Free Encyclopedia.** 2005. Growing degree days. <[en.wikipedia.org/wiki/Growing\\_degree\\_day](http://en.wikipedia.org/wiki/Growing_degree_day)>.
- Wunderground.com.** Accessed 2005. Growing degree days. <[www.wunderground.com/about/faq/degreedays.asp](http://www.wunderground.com/about/faq/degreedays.asp)>.

## Propagating Wild-Collected Seed of Woody Species<sup>®</sup>

### Shelley Dillard

Morris Arboretum of the University of Pennsylvania, 100 Northwestern Ave., Philadelphia, Pennsylvania 19118 U.S.A.

In propagation by seeds, the goal of the propagator is to obtain the highest germination percentage possible and one that will hopefully result in a healthy plant. Germination rates are affected by the time of collection, cleaning procedures, storage, moisture content of the seed, and other factors in addition to the treatments given to the seed to induce germination. These are factors that cannot always be controlled, particularly in wild-collected seeds.

The Morris Arboretum of the University of Pennsylvania has a long history of domestic and international plant exploration and seed collection (Aiello, 2004). Among the goals of these explorations is to obtain new sources of germplasm for common species of plants, as well as to obtain seed from unusual or less common species. Plants propagated are added to the Arboretum's living collection and distributed to other institutions and nurseries.

A recent trip to the Republic of Georgia produced seeds from species such as *Abies nordmanniana*, *Fagus orientalis*, *Tilia dasystyla*, and others. These are species for which there may not be a body of research relative to propagation. There are a number of strategies that will further the goal of germination.

It is first helpful to assess the viability of the seed. This would, hopefully, be done in the field via a cut test to determine if the fruit contains a viable seed. Many species, such as *Acer griseum*, produce fruit that contain a small percentage of viable seed. Knowing this will influence the number of seeds collected as well as effects the calculation when establishing a final germination percentage. If seeds cannot be processed immediately—and they frequently cannot be when received en masse—they should be cleaned and refrigerated.

The first step in determining a germination protocol is to check reference books. At the Arboretum, records from the past 25 years are also accessed. If information is not available for the specific species, e.g., *Tilia caucasica*, refer to simply another *Tilia* species. As a last resort, refer to general propagation information for the genus. If enough seed is available, it is helpful to try different treatments, including varying combinations of warm and cold stratification. At the Arboretum, all seeds that need stratification are placed in plastic bags in moist perlite. This allows for moisture to be available for uptake by the seed without rotting the seed. Small seeds may be sown in trays in a mix of 3 perlite : 2 peat (v/v) and placed in a plastic bag for stratification. Since the general guideline used in determining the pre-germination treatments for a woody seed are those that would occur in nature, seeds are often sown in trays and placed in a cold glasshouse and left for nature to take its course. The Arboretum has a glass house (the "Medicinal House") that it maintains during the winter months at 35 °F. On sunny winter days, the temperature may fluctuate, but the fluctuation of cold and warm temperatures is sometimes what is needed to break dormancy.

Following are some examples of seeds that were collected in the Republic of Georgia and successfully propagated at the Morris Arboretum. Seeds were collected in approximately September 2004 and received at the Arboretum in early November



2004. Seeds arrived mostly cleaned, and some were packed in moist sphagnum.

Enough seed of *F. orientalis* was received that we were able to sow only those that appeared plump and healthy. They were sown in trays and placed in the Medicinal House from 5 Nov. 2004 through 21 Feb. 2005, when one seedling was observed to have emerged. The tray was removed from the Medicinal House and placed in the propagation greenhouse with 65 °F air temperature and 70 °F soil temperature. Sixteen of the 25 seeds germinated.

*Abies nordmanniana* was successfully germinated by all the methods. Either 1-month cold stratification in moist perlite at 41 °F, or direct sown and placed in the Medicinal House. The 2-months-warm/3-months-cold stratification was somewhat more successful but not statistically significant. The key to successful propagation of *Abies* and most conifers is dusting the seed with a fungicide such as Captan before any other treatments.

Two treatments of *Carpinus orientalis* were both successful. The first treatment of 2-months-warm followed by 3-months-cold stratification was slightly more successful than the second treatment of direct sowing and placing in the Medicinal House. Different collections (seeds collected from different trees/at different times) germinated better than others, but the reasons for the different germination rates are unclear.

Two accessions of *Picea orientalis* were both sown in flats and placed in the Medicinal House at the same time. One accession had excellent germination, while the second failed to germinate. Once again, the seeds were collected from different plants in different places.

*Tilia caucasica* showed, once again, varying results. The typical treatment of sulfuric acid followed by cold stratification worked "well enough," but produced no real data to swear by.

*Zelkova carpinifolia* successfully germinated with all treatments. The easiest method was 2-months-cold stratification at 41 °F in moist perlite prior to sowing.

While the reasons for failure are often unknown, sometimes they may be very clear. Two accessions of *Pinus sylvestris* var. *hamata* were given the same treatments. One treatment was completely successful with 100% germination, while the second was a complete failure. Further inquiry revealed that the seeds were removed from the cones after collection and before transportation to the Arboretum by drying in an oven. The accession that failed to germinate had been left in the oven too long and was good only for eating.

The factors affecting germination range from sterile seeds to human error. Propagating wild-collected seeds is a challenge not for the faint of heart. It can be wildly frustrating or hugely rewarding, and is usually both. The successful propagator views each success as a personal triumph and each failure as a signpost on the road to success.

#### LITERATURE CITED

Aiello, A.S. 2004. Cold hardiness evaluation of *Cornus kousa* provenance *Cornus* provenances. Comb. Proc. Intl. Plant Prop. Soc. 54: 494-498.

## Plant Exploration: Gamble for the Big Payoffs®

### James Harbage

Longwood Gardens, Inc., PO Box 501, Kennett Square, Pennsylvania, 19348 U.S.A.

Longwood Gardens is a world premier horticultural display garden created by Pierre DuPont between 1906 and 1954. The gardens opened to the public in 1956. About 250 acres out of a total 1050 are display gardens open to public viewing and include about 4 acres of heated conservatories. The display gardens have over 10,000 plant accessions in a mixture of permanent and seasonal plantings. There are an additional 3,000 plus accessions in research trials at any given time. The seasonal plantings are changed an average of four times per year outdoors and six times per year in the conservatories.

Longwood Gardens has engaged in plant exploration since 1956 and has sponsored over 50 trips to as many countries in the past 50 years. Expeditions have encompassed every continent except Antarctica.

Explorer	Destination
Frank Kingdon Ward	Burma
John Creech	Japan, Union of Soviet Socialist Republics, Nepal, Taiwan
Walter Hodge	Australia, Indonesia, West Indies
Russell Siebert	South America, South Africa, Peru, Mexico, West Indies, Costa Rica, Honduras
Richard Lighty	South Korea, Honduras, Costa Rica
Rick Darke	South Africa, Japan, Germany, Australia, United Kingdom
Darrel Apps	South Korea, United Kingdom
Robert Armstrong and Roger Lawson	Japan, Singapore, Indonesia, Australia, New Zealand
Bill Thomas	South Korea, China, Japan
Jim Ault	United Kingdom, South Africa, China
Tomasz Anisko	China, Tibet, Georgia, Chile, Azerbaijan, Greece, Russia, Australia

The most recent trips have been to Australia, Chile, China, Greece, Guyana, and Russia.

Thousands of plant collections have been made, and a few notable ones are: *Trochodendron aralioides*, *Ilex crenata* 'Sky Pencil', *Pericallis papyracea* (cineraria), New Guinea impatiens, *Tsuga chinensis*, and many camellias including *Camellia azalea*.

Longwood Garden's emphasis on plant exploration has occurred for a number of reasons. One reason is that Longwood's mission includes an emphasis on performing research that will make positive contributions to the horticultural community. Longwood is also continually searching for plants that can be used to keep their displays ever-changing and extraordinary. Participation in plant exploration trips also

gives Longwood staff a first-hand opportunity to observe potentially useful plants in their native environment before attempting to cultivate them. And lastly, plant exploration often provides excellent personal contacts for future germplasm exchanges. Plant exploration and distribution will become increasingly important to maintain genetic diversity as native species around the world are being eliminated due to habitat destruction for land development and intensive agriculture.

Plant exploration is becoming more of a gamble as a result of the globalization of agriculture. Many nations have announced ownership of their genetic resources and are strictly controlling export of them. This concept gained wide acceptance as a result of the Convention on Biological Diversity (CBD). The intent of the CBD is to allow each nation to be the first to benefit economically from its own genetic resources. While this concept will no doubt prove to be morally right in the future, the complexity of implementing it is significantly slowing the pace of germplasm rescue. As a result, plant collecting is now more complicated or not possible in many countries.

Another increasing concern around the world is the spread of "invasive exotics." In this country, this has led the United States Department of Agriculture's (USDA) Animal and Plant Health Inspection Service (APHIS) to reevaluate its regulations governing the import of plants for planting (commonly called Q-37). One option being considered for the revised guidelines is to prevent the import of some or all plants for planting until regulated testing has taken place to assure there is no risk of invasiveness from the imported plant material. While this also is idealistically the right measure to protect against serious negative germplasm invasions, it is quite possible that implementing and regulating the evaluation procedures will be a significant challenge and drastically change the rate at which plants move across national boundaries for some time.

For these and other reasons, it is increasingly important that thorough planning go into any plant exploration effort before it takes place to reduce the risk that initial expectations are not met. A recent plant exploration trip undertaken by Longwood Gardens can be used as an example of some of the challenges that should be considered when planning an expedition.

In 2004 Longwood staff agreed a plant exploration trip to Australia was warranted. Reasons for the trip included:

- Observation of species in their native habitat to help developing cultivation techniques.
- Acquisition of untried species.
- Acquisition of new cultivars not currently available in the U.S.A.
- Making new personal contacts with plant experts in Australia for information and plant exchange.

It had been 13 years since Longwood staff had traveled to Australia, and the garden was using and planning expanded use of Australian native flora in current and future displays.

Longwood staff Tomasz Anisko and Jim Harbage planned a trip that would take 3 weeks and would spend roughly two-thirds of the trip observing native flora in the field (bush) and the last third of the trip acquiring plants. The trip would start in Perth and make a large circuit in West Australia (road) going north, staying close to the coast, as far as Kalbarri National Park and then traveling back south, somewhat further inland, as far south as Mount Barker and visiting the Sterling Range.

This loop would cover an area of intense biodiversity. Australia is home to around 24,000 species, and about 10,000 occur in West Australia. The trip would then proceed by air east to Adelaide where it would continue by road to Melbourne. From Melbourne they would fly to Sydney where they would complete the trip by touring the area around Sydney. Melbourne and Sydney have the greatest concentration of nurseries in Australia. The plans also called for visiting nine botanic gardens and eleven nurseries (specializing in native plants) during the course of the trip.

The initial investigations indicated there would not be an opportunity to collect plants from the wild without signing agreements requiring extensive post-collection permits for redistribution or plant naming/release efforts. So the plan was to simply purchase commercially available plants at nurseries. Arrangements were made to have the plants delivered to an Australian nursery, which would then ship cuttings back to Longwood at a later date.

Several lessons were learned during the course of this trip. We learned that the environment many of the plants live in is very harsh, with minimal precipitation, low humidity, and high daytime temperatures. The soils were often very thin with little organic matter and were frequently made up of gravel over clay.

The Australian native flora was spectacular, with tremendous variation in texture, color, and habit. Examples of unusual texture included foliage and flowers of *Dryandra*, *Grevillea*, and *Banksia* species. Flower colors were also very diverse. There seemed to be an exceptionally large number of blue-flowered plants including *Lechenaultia*, *Dampiera*, *Hybanthus*, *Conospermum*, and *Hovea* species. Plants with silver foliage also predominated such as species of *Eremophila*, *Lachnostachys*, *Eucalyptus*, *Conospermum*, and *Leucophyta*. There were also many plants with vibrant red and orange flowers such as a red-flowered *Lechnaultia*, *Banksia coccinea*, *Chorizema glycinifolium*, *Telopea speciosissima*, *Eucalyptus caesia*, and the bizarre *Swainsona formosa*.

We learned we could not import plants with Plant Breeder's Rights without special written permission from the license holder. We also could not import members of the genus *Acacia* or the *Rutaceae* family due to U.S.D.A. restrictions.

Australian Botanic Gardens have vigorously adopted the tenants articulated at the Convention on Biological Diversity (CBD). However, most Australian Nursery Owners don't know or care about the CBD. Australian Plant Selectors are fearful of losing their newly released plants to the U.S.A., but feel it is too expensive for them to pursue patenting them in the U.S.A.

We imported cuttings of 72 different plants and seeds of another 30 different plants from Australia, which we are now propagating and growing in our research trials. We expect many of these plants to be exciting new additions to our conservatory displays in the future.

## Cutting Edge Perennials: No Bandages Provided!!!<sup>©</sup>

### Stephanie Cohen

4046 Township Line Road, Collegeville, Pennsylvania 19426 U.S.A.

Below is listed the plants discussed during the presentation.

Plant list	Common name	Zone
<i>Achillea millefolium</i> 'Red Velvet'	yarrow	Z3
<i>Achillea tomentosa</i> 'Golden Fleece'	wooly yarrow	Z3
<i>Aconitum</i> 'Pink Sensation'	monkshood, wolfbane	Z4
<i>Agastache</i> 'Black Adder'	anise hyssop	Z6
<i>Amsonia</i> 'Blue Ice'	blue star	Z5
<i>Anemone crispa</i>	anemone	Z5
<i>Aquilegia chrysantha</i> 'Yellow Queen'	golden columbine	Z4
<i>Astilbe</i> 'Burgundy Red'	astilbe	Z4
<i>Boltonia asteroides</i> 'Jim Crockett'	Bolton's aster	Z3
<i>Brunnera macrophylla</i> 'Looking Glass'	heartleaf brunnera	Z3
<i>Centaurea montana</i> 'Amethyst in Snow'	cornflower	Z3
<i>Coreopsis pubescens</i> 'Sunshine Superman'	star tickseed	Z6
<i>Coreopsis grandiflora</i> 'Rising Sun'	tickseed	Z4
<i>Delphinium</i> 'Coral Sunset'	hybrid delphinium	Z2
<i>Delphinium</i> 'Darkness Visible'	hybrid delphinium	Z2
<i>Dianthus</i> 'Shooting Star' (Star Series)	pinks	Z5
<i>Dicentra</i> 'Ivory Hearts'	fern-leaved bleeding heart	Z5
<i>Echinacea</i> 'Matthew Saul', Harvest Moon™ coneflower	coneflower	Z4
<i>Echinacea</i> 'Fragrant Angel'	coneflower	Z4
<i>Echinacea</i> 'CBG Cone2', Pixie Meadowbrite™ coneflower	coneflower	Z4
<i>Echinacea</i> 'Evan Saul', Sundown™ coneflower	coneflower	Z4
<i>Euphorbia characias</i> 'Black Pearl'	Mediterranean spurge	Z6
<i>Euphorbia</i> × <i>martinii</i> 'Aperitif' or <i>E.</i> 'Mini Martini'	spurge	Z6
<i>Gaillardia</i> × <i>grandiflora</i> 'Arizona Sun'	blanket flower	Z3
<i>Geranium cinereum</i> 'Sateene'	grayleaf cranesbill	Z5
<i>Geranium sinese</i>	cranesbill	Z5
<i>Hakonechloa macra</i> 'All Gold'	hakone grass	Z5
<i>Helenium flexuosum</i>	sneezeweed, Helen's flower	Z4
<i>Helleborus niger</i> 'Ivory Prince'	Christmas rose	Z3
<i>Helleborus</i> × <i>hybridus</i> Brandywine Series	Lenten rose	Z4
<i>Heuchera</i> 'Frosted Violet'	coral bells	Z4
<i>Heuchera villosa</i> 'Carmel'	hairy alumroot	Z4

<i>Hibiscus</i> 'Pinot Noir' (Vintage Series)	hardy hibiscus	Z4
<i>Iris cristata</i> 'Powder Blue Giant'	dwarf crested iris	Z5
<i>Iris</i> 'Cherry Garden'	dwarf iris	Z4
<i>Kalimeris incisa</i> 'Blue Star'	Japanese aster	Z5
<i>Leucanthemum</i> × <i>superbum</i> 'Phylliss Smith'	shasta daisy	Z5
<i>Leucanthemum</i> × <i>superbum</i> 'Sonnenschein' (syn. 'Sunshine')	shasta daisy	Z5
<i>Liatris spicata</i> 'Kobold Original'	spike gayfeather	Z3
<i>Ligularia japonica</i>	Japanese ligularia	Z4
<i>Miscanthus sinensis</i> 'Super Stripe'	miscanthus	Z5
<i>Monarda</i> 'Raspberry Wine'	bee balm	Z3
<i>Muhlenbergia capillaris</i>	muhly grass	Z7
<i>Muhlenbergia capillaris</i> (White)	muhly grass	Z7
<i>Mukdenia rossii</i> 'Crimson Fans'		Z4
<i>Paeonia</i> 'Apron Strings'	peony	Z3
<i>Paeonia</i> 'Pedigree Cat'	peony	Z3
<i>Papaver orientale</i> 'Queens' (New York Series)	Oriental poppy	Z2
<i>Pennisetum alopecuroides</i> 'Fox Trot'	tall fountain grass	Z5
<i>Persicaria affinis</i> Jo and Guido's Form	mountain fleecflower	Z3
<i>Phlox paniculata</i> 'Midnight Feelings'	garden phlox	Z3
<i>Phlox paniculata</i> 'David's Lavender'	garden phlox	Z3
<i>Polygonatum</i> × <i>hybridum</i> 'Striatum'	striped Solomon's seal	Z3
<i>Pulmonaria</i> 'Moonshine'	lungwort	Z4
<i>Sanguisorba</i> 'Tanna'	great burnet	Z4
<i>Scutellaria ovata</i>	heart-leaved skullcap	Z4
<i>Scutellaria suffrutescens</i>	cherry skullcap	Z6
<i>Sedum</i> 'Black Jack'	showy stonecrop	Z3
<i>Sedum</i> 'Pink Chablis' <sup>PBR</sup>	showy stonecrop	Z3
<i>Seseli gummiferum</i>	(biennial or short-lived perennial)	Z4
<i>Symphotrichum</i> (syn. <i>Aster</i> ) <i>cordifolius</i> 'Annabelle'	blue woods aster	Z3
<i>Thalictrum</i> species 'Black Stockings'	meadow rue	Z5
<i>Thermopsis chinensis</i> 'Sophia'	false lupine	Z5
<i>Tiarella</i> 'Crowfeather'	foamflower	Z4
<i>Tricyrtis formosana</i> 'Purple Beauty' <i>T.</i> 'Empress'	toad lily	Z5
<i>Tricyrtis hirta</i> 'Raspberry Mousse'	toad lily	Z5
<i>Veronica spicata</i> 'High Five'	spike speedwell	Z3
<i>Veronica spicata</i> 'Tickled Pink'	spike speedwell	Z3
<i>Veronicastrum virginicum</i> 'Erica'	Culver's root	Z4

Coming attraction *Hemerocallis* 'Stephanie Returns'!

### My Special Thanks to these Wonderful Businesses:

Benary Seeds	Jelitto Perennial Seeds
Blooms of Bressingham	North Creek Nursery
Center Greenhouse	Plant Haven
Centerton Nursery	Pride of Plants
Conard-Pyle Company	Rick Darke
Creek Hill Nursery	Song Sparrow Nursery
Darwin Plants	Stonehouse Perennials
Devroomen Nursery	Sunny Border Nursery
Greenleaf/Yoders	Terra Nova Nursery
Hoffman Nursery	Walters Nursery
Intrinsic Perennials	Woodside Gardens

---

## Plants and Substrates Are the Heart of the Green Roof®

### David J. Beattie and Robert D. Berghage

Center for Green Roof Research, Department of Horticulture, The Pennsylvania State University, University Park, Pennsylvania 16802 U.S.A.

### Edmund Snodgrass

Emory Knoll Farms, 3410 Ady Rd. Street, Maryland 21154 U.S.A.

Although ground-level garden perennials have the widest range of landscape uses, the building roof presents a new and unique environment and opportunity where a wide range of perennials can not only beautify, but also serve several unique environmental functions, including storm water management and urban heat island reduction.

Green roofs, sometimes called eco-roofs, are roofs planted with vegetation and have been used for centuries, especially those characterized by deep soil layers. Examples include 5000-year-old passage tombs in Ireland covered with sod roofs. Settlers in Nebraska covered their roofs with sod, and more recently the rooftop gardens of Rockefeller Center have created an oasis in the center of Manhattan. These deep roof-type gardens have served a number of protective and aesthetic functions. They are usually constructed with soils more than 1 ft deep and have been designated, in the modern vernacular, as intensive roof gardens.

About 30 years ago, a new type of green roof, called an extensive green roof, was developed in Germany and Switzerland. Extensive roofs are lightweight, with thin layers of substrate, and are used mostly for storm water mitigation in the densely populated cities of Europe where building density is higher than in the U.S.A. Today, nearly 24% of the flat roofs in the city of Stuttgart, Germany, have been greened. Germany boasts more than 1 billion square feet of extensive green roofs, mostly on flat industrial roofs. Today, in the city of Basel, Switzerland, every new flat roof must be greened. Green roofs are just beginning to be used in the U.S.A., the most famous being the one on the Ford River Rouge auto plant in Detroit. The



### My Special Thanks to these Wonderful Businesses:

Benary Seeds	Jelitto Perennial Seeds
Blooms of Bressingham	North Creek Nursery
Center Greenhouse	Plant Haven
Centerton Nursery	Pride of Plants
Conard-Pyle Company	Rick Darke
Creek Hill Nursery	Song Sparrow Nursery
Darwin Plants	Stonehouse Perennials
Devroomen Nursery	Sunny Border Nursery
Greenleaf/Yoders	Terra Nova Nursery
Hoffman Nursery	Walters Nursery
Intrinsic Perennials	Woodside Gardens

---

## Plants and Substrates Are the Heart of the Green Roof®

### David J. Beattie and Robert D. Berghage

Center for Green Roof Research, Department of Horticulture, The Pennsylvania State University, University Park, Pennsylvania 16802 U.S.A.

### Edmund Snodgrass

Emory Knoll Farms, 3410 Ady Rd. Street, Maryland 21154 U.S.A.

Although ground-level garden perennials have the widest range of landscape uses, the building roof presents a new and unique environment and opportunity where a wide range of perennials can not only beautify, but also serve several unique environmental functions, including storm water management and urban heat island reduction.

Green roofs, sometimes called eco-roofs, are roofs planted with vegetation and have been used for centuries, especially those characterized by deep soil layers. Examples include 5000-year-old passage tombs in Ireland covered with sod roofs. Settlers in Nebraska covered their roofs with sod, and more recently the rooftop gardens of Rockefeller Center have created an oasis in the center of Manhattan. These deep roof-type gardens have served a number of protective and aesthetic functions. They are usually constructed with soils more than 1 ft deep and have been designated, in the modern vernacular, as intensive roof gardens.

About 30 years ago, a new type of green roof, called an extensive green roof, was developed in Germany and Switzerland. Extensive roofs are lightweight, with thin layers of substrate, and are used mostly for storm water mitigation in the densely populated cities of Europe where building density is higher than in the U.S.A. Today, nearly 24% of the flat roofs in the city of Stuttgart, Germany, have been greened. Germany boasts more than 1 billion square feet of extensive green roofs, mostly on flat industrial roofs. Today, in the city of Basel, Switzerland, every new flat roof must be greened. Green roofs are just beginning to be used in the U.S.A., the most famous being the one on the Ford River Rouge auto plant in Detroit. The

main function of these roofs is to mitigate storm water. On an annual basis a 3- to 4-inch-deep extensive green roof can retain about 50% of the storm water that falls on the roof in most areas of the eastern U.S.A.

In addition to storm water mitigation, green roofs can be installed for beauty, air filtration, and trapping air-borne particles, wildlife habitat, noise suppression, insulation — especially for air conditioning savings — and urban heat island reduction.

While other technologies can out-perform green roofs in achieving any of these individual benefits, none have the potential to encompass all of the benefits on a single roof the way extensive green roofs can.

As America continues to urbanize and pave (seal) more land for roads, parking lots, and building footprints, storm water systems cannot handle the increased run-off loads. All large cities east of the Mississippi have storm water problems. The traditional (engineering) method of coping with this problem has been to install increasing larger drainage pipes.

Constructions costs and the disruption of urban areas needed to replace storm water drainage systems are so high that the burden on public funding has become excessive. Therefore, public policy is gradually shifting the cost of dealing with storm water to the individual developer. One of the least expensive and most environmentally sound methods has been to install extensive green roofs. While the technology has been well developed in Germany, experience has shown that their methods and systems cannot be directly applied to all American situations. Not only can green roof technology help solve increased runoff problems, it represents a wide range of new market opportunities for those involved in the design and installation processes (Fig.1). As a new landscape dimension it can beautify the rooftop landscape of our cities and add value to its buildings. In the process it attracts new customers that buy new products. In addition, building owners feel good about improving the local environment, and it will postpone the need to re-roof their buildings for perhaps decades.

However, market inhibitors must also be carefully considered. As a new, immature market, there is a lack of knowledge in some critical areas. There is little R&D investment in the American green roof paradigm. Payback times are often beyond what market analysts are comfortable with. Green roofs are a long-term investment, but the paybacks can be considerable. When considering roof replacement alone (and without considering all the other benefits), a green roof can pay for itself in 30 years. Availability of suitable plants and substrates may also impede growth of this market. Because of the unique requirements of the roof microclimate, plants and substrates must be carefully chosen. After the job is finished, placing its care in the hands of a building superintendent can have disastrous results. Thus, market and horticultural solutions must be adapted to the particular roof. To answer some of these questions, the Center for Green Roof Research at the Pennsylvania State University was founded in 2001.

Two of the most important factors in establishing a successful green roof are choosing the right plants and the right growing medium; choosing the right growing medium is probably the more difficult. Media for extensive green roofs have no soil, but are based on various multifunctional lightweight minerals including expanded clay, slate, shale, or volcanic materials. The FLL, a German industry group, similar in some respects to the American ASTM, sets standards for green roof installation in Germany and publishes general guidelines on substrate physical and chemical

properties. Bulk density, aeration, and pH are particularly important. A synopsis of substrate characteristics is found in Table 1.

**Table 1.** Synopsis of characteristics for a green roof medium.

80%–90%	Light-weight aggregate	Expanded slate, shale, or clay
	Particle size	$1/8$ – $5/8$ screen
	Dry weight	32–42 lbs/ft <sup>3</sup>
10%–20%	Organic matter	Weed, soil, and herbicide free
Mixed medium weight		40–46 lbs/ft <sup>3</sup>
Saturated medium weight		55–60 lbs/ft <sup>3</sup>
3-inch depth dry medium		10–13 lbs/ft <sup>2</sup>
3-inch depth saturated medium		17–20 lbs/ft <sup>2</sup>
Medium ordering calculations		Medium depth (inches) × square footage of roof divided by 324 = yds <sup>3</sup> of medium to order

Many American roofs have lower weight-bearing capacities than European roofs, so mineral bulk density is especially important. Most commercial flat roofs in the U.S.A. cannot support more than 15–25 lbs/ft<sup>2</sup>, which would be equal to a saturated medium about 3–4 inches deep. If you are unsure of the weight carrying capacity of the roof, consult an engineer. Roof loading, wet weight per square foot, can be changed by reducing medium depth or using a lighter weight substrate. However, roof substrate depth in the Northeastern U.S.A., for most situations, should not be less than 3 inches for good plant growth. Aeration is also important because plant roots need a well-aerated environment to actively take up water and nutrients. Aeration is also important for hydraulic conductivity, allowing excess water to exit the roof through drains. Likewise, pH is also important for good plant growth. A substrate with long-term pH stability between 6 and 7 is desirable. Many think that a green roof medium should contain lots of organic matter. However, organic matter will break down with bacterial action thus reducing the effective growing depth and compromising plant growth. No more than 20% (by volume) organic matter is recommended and only that amount when the roof is planted in late summer. If planted in spring, 10% organic matter is sufficient. Organic matter adds water-holding capacity, especially for late summer planting, and some cation exchange capacity. Finally a small amount of a slow-release fertilizer can be added to the medium at planting time. All green roof media used in Germany adhere to FLL physical and chemical standards. Recently, Penn State University's Soil Testing Lab has begun testing media using FLL standards. This service should result in more uniform and reliable green roof media and fewer mistakes.

The second most important consideration for a successful green roof is the proper choice of plants. Europeans have found that succulents, like sedums and delospermas, have been most reliable in these shallow roof systems. Sedums and delospermas are members of the botanical family Crassulaceae, a close relative of the cactus. These taxa are heat-, cold-, and drought-tolerant perennials. Most are low



**Figure 1.** Green roof can even adorn Smart Car roofs.



**Figure 2.** New bamboo culms and many grass stolons are sharp enough to penetrate the roof membrane.

growing, so produce relatively little biomass. Large amounts of biomass on a roof can present problems for both maintenance and fire safety. Generally, if grasses are used, short varieties like fescues should be selected and used only as accent plants. In this way biomass accumulation can be minimized.

Choosing low-growing succulents does not exclude the use of other plants like native herbaceous perennials or annuals, but succulents have a proven track record. Further, we have almost no information on how most native plants perform in the extensive roof environment. Even succulent choices here must be made carefully. For instance, *Delosperma nubigenum* is reliably winter hardy in Maryland, but not in State College, Pennsylvania. In another example, *Sedum acre* seems to do well in the cool summer weather of State College, but “melts out” in the heat of Washington, D.C. When planting a roof, it is recommended that at least 10 different plant taxa be used. In this way, if something happens to some, others will fill in.

Although plants on most green roofs are placed there for storm water mitigation purposes, there are several other attributes that are important. Aesthetics, particularly flower and foliage color, can be very important when the roof is seen from above. Plants take up water and store it in their leaves. In the process of releasing it through their stomates, not only is water released, but also the air around the roof surface is cooled. If enough green roofs could be installed in a city, the heat island so prevalent in today's mega cities could be substantially reduced. Recent research has also shown that the cooling effect of the plants can increase the efficiency of photovoltaic cells when placed on the roof and reduce the air conditioning demand for an individual building.

There are several ways green roof plants, especially succulents, can be propagated. Depending on the needs of the job, propagation can occur either off-site, or on the roof, using either cuttings or seed. *Sedum* seeds are very small and, while best propagated off site, they can be mixed with hydro mulch and sprayed directly over the roof substrate. No reliable formulas for how much seed of each taxon to use for each method have been published.

Finally, green roof plants should not have strong, sharp stolons or rhizomes. Bamboos are NOT a recommended green roof plant as are several grasses with aggressive stolons. They may be expected to puncture the membrane creating leaks (Fig. 2).

The best time to establish a green roof is in spring, although roofs can be planted until frost. Some type of irrigation should be available at planting to provide for successful establishment. In some especially dry areas, permanent irrigation can be installed, but beyond establishment irrigation systems, particularly in-ground (roof) systems are probably unnecessary.

Green roof maintenance should not be overlooked. Yearly inspections should be no different than that for a ballasted roof. The same regular inspections should be practiced for green roofs. Occasional hand pulling of tree seedlings is sufficient. However, plants like clover, because of their extensive underground root and shoot system, may require the application of small amounts of an herbicide. Good maintenance, though, starts with a weed-free medium. Finally, yearly applications of a slow-release fertilizer at a rate of 5 g N per 1000 ft<sup>2</sup> will maintain plant health, but not result in excessive nitrogen runoff. Liming every 5–10 years is also recommended.

Green roofs are gradually being introduced into American markets. However, lack of installation experience, substrate standards, and plant performance information slow market acceptance. With time, these market inhibitors will be overcome and green roofs could be as common as they are in Europe.

## New Introductions from Europe®

**Gert Fortgens**

Honingerdijk 86, Rotterdam, 3062 NX, The Netherlands

### TREES AND SHRUBS

- *Aralia elata* 'Golden Umbrella'. Wide gold leafmargin, more vigorous grower than 'Aureomarginata' and easier to propagate, no scorching of leaves in summer.
- *Berberis thunbergii* 'Admiration'. From Czech Republic, dense dome shape; young shoots orangebrown colored, leafmargin wide gold rim.
- *Buxus microphylla* 'Peergold', Golden Dream™ boxwood. Found as a variegated sport on 'Faulkner', leaf margins in summer bright gold, in winter yellowish green, young shoots and wintercolor orange-bronze, habit rounded.
- *Corylus avellana* 'Anny's Purple Dream'. A compact form with deep-purple-colored foliage. Ideal for grafting.
- *Forsythia × intermedia* 'Goldraush'. A German selection with a great advantage over many other Forsythia's; the flowers are formed on the young (1st year's) shoots. The flowers are very large and deep yellow.
- *Hebe* 'Heartbreaker' <sup>PBR</sup>. A compact-growing hebe, foliage grey-green with a cream-colored margin. Foliage turns purple from October to May. Withstands only mild frosts. Sport of 'Dazzler' with better color and more vigorous grower.
- *Pieris japonica* 'Katsura'. Originates from Japan, young foliage maroon, later bright red, flowers pink.
- *Sophora japonica* 'Karaca Weeping'. Different form of the weeping *Sophora*, leaves smaller and finer branching.
- *Sorbaria sorbifolia* 'Sem' <sup>PBR</sup>. Originated as a seedling, more compact in habit, young shoots orange-bronze colored later yellowish green, flowers white.
- *Weigela florida* 'Verweig', Monet™ weigela. Dense, mound-forming shrub, foliage variegated, changes color from spring to fall.

### PERENNIALS

- *Agapanthus* 'White Heaven' <sup>PBR</sup>. A tall African lily with extremely large pure-white flowers. Because of the long and strong stems also excellent as a cut flower.
- *Aster ageratoides* 'Starshine'. Compact, mildew-free selection, flowers earlier than other *A. ageratoides* selections.
- *Clematis* 'Zobluepi', Blue Pirouette™ clematis. Bears upright, dark violet-blue flowers; tepels elegantly twisted, height to 1.8 m but also with groundcover potential, perennial-type clematis so cut back in spring to 25 cm.

- *Clematis* 'Hendryetta'. Small, dark green leaves, flowers bell shaped, nodding scented, tepals pink, ideal for winding through roses or shrubs, perennial-type clematis so cut back in spring to 25 cm.
- *Cortaderia selloana* 'Splendid Star'. Originated as a sport in *C. selloana* 'Pumila' with a height to 1 m. A dwarf golden pampas grass that is quite unique with golden streaked leaves that stay on the plant all year. Elegant white flower plumes are produced in late summer.
- *Echinacea purpurea* 'Razzmatazz'<sup>PBR</sup> and 'Doppelgänger'. This and other unnamed selections of coneflower are semi-double to full-double flowered selections.
- *Geranium* 'Sirak'. A sterile hybrid and the parentage is *G. gracile* and *G. ibericum*. It has large mauve-pink flowers with dark veins. Received an AGM in Great Britain last year.
- *Helenium* 'Potter's Wheel' glowing brown-red flower with a small yellow margin, a rather big, very expressive flower; mid-late; height 135 cm.
- *Helenium* 'Sahin's Early Flowerer'. A *Helenium* with yellow and bronze bicolor flowers, blooms continuously throughout the whole summer on strong stems, needs no staking.
- *Leucanthemum* × *superbum* 'Sonnenschein' flowers are single, pale creamy-lemon fading to white, with a gold eye, 75 cm.
- *Sedum* 'Ruby Port' deep purple leaves and stem, deep-red flowers.
- *Solidago* 'Ducky'. A very compact and short goldenrod, mildew free, and of hybrid origin. *Solidago* 'Laurin' × *S. flexicaulis*.
- *Verbascum* 'Rosie' is a sport of *Verbascum* 'Jackie'. The flowers are lovely pink with dark overtones. It reaches a mature height of 30 cm.



## New Plant Forum®

Compiled and Moderated by Jack Alexander

### Presenters:

**Jack Alexander** presenting for: Tim Brotzman,  
Brotzman Nursery, 6899 Chapel Rd., Madison, Ohio 44057 U.S.A.

*Cornus kousa* var. *chinensis* 'Madison' PP# 16129 Crown Jewel™ Chinese dogwood

### Andrea Bonville

Princeton Nurseries, P.O. Box 185, Allentown, New Jersey 08501 U.S.A.

*Acer tataricum* subsp. *ginnala* 'Ruby Slippers'

### Allen Bush

Jelitto Perennial Seeds, 125 Chenoweth Lane, Suite 301, Louisville, Kentucky 40207 U.S.A.

*Thermopsis chinensis*

### Jeremy Deppe

Spring Meadow Nursery, Inc., 12601 120th Ave. Grand Haven, Michigan 49417 U.S.A

*Cornus alternifolia* 'Wstackman' PP# 11,287, Golden Shadows® dogwood

*Corylus avellana* 'Red Majestic' PPAF

*Hydrangea paniculata* 'DVPpinky' PPAF, Pinky Winky™ paniced hydrangea

*Hydrangea paniculata* 'Bulk' PPAF, Quick Fire™ paniced hydrangea

### Chuck Flinn

Musser Forests, Inc, 1880 Route 119 HWY N Indiana, Pennsylvania 15701 U.S.A.

*Pinus sylvestris* 'Slim Jim'

### Harlan Hamernik

Bluebird Nursery, P.O Box 460, 519 Bryan Street, Clarkson, Nebraska 68629 U.S.A.

*Andropogon gerardii* Silver Sunrise™ big bluestem

*Clematis tenuiloba* 'Pixie Parasols'

*Sedum tatarinowii* 'Mongolian Stardust'

*Echinacea purpurea* 'Prairie Giant'

*Caragana microphylla* 'Mongolian Silver Spires'

### Alan Jones

Presenting for: PlantHaven, Inc., 121 West Pueblo Street, Suite 14, P.O. Box 3056, Santa Barbara, California 93130-3056 U.S.A.

*Abelia × grandiflora* 'Kaleidoscope' PPAF

*Cercis canadensis* 'Hearts of Gold' PPAF

**Susanne Lucas**

Pioneer Plants LLC, 9 Bloody Pond Road, Plymouth, Massachusetts 02360 U.S.A.

*Fargesia rufa* 'Rufa', Green Panda™ bamboo

*Fargesia robusta* 'Pingwu', Green Screen™ bamboo

*Fargesia angustissima* 'Oprin's Selection', Green Jewel™ bamboo

*Fargesia* sp. 'Jiuzhaigou', Red Panda™ bamboo

*Fargesia scabrida* 'Oprin's Selection', Asian Wonder™ bamboo

**Chad Osborn**

Chicagoland Grows, Inc., 1000 Lake-Cook Road, Glencoe, Illinois 60022-0400 U.S.A.

*Baptisia* × *variicolor* 'Twilite Prairieblues' PPAF

*Buxus* 'Wilson', Northern Charm™ boxwood

*Echinacea* 'CBG Cone2' PPAF, PBR AF, Pixie Meadowbrite™ coneflower

**Peter Podaras**

Presenting for: Harold Pellett, Landscape Plant Development Center, P.O. Box 444 Mound, Minnesota 55364 U.S.A.

*Pyrus* 'Silver Ball'

*Clematis* 'Center Star' PPAF

*Physocarpus opulifolius* Center Glow™ ninebark

**Adam Wheeler**

Broken Arrow Nursery, 13 Broken Arrow Rd. Hamden, Connecticut 06518 U.S.A.

*Kalmia latifolia* 'Firecracker'

*Hamamelis virginiana* 'Harvest Moon'

***Abelia* × *grandiflora* 'Kaleidoscope'**

**Origin:** 'Kaleidoscope' was selected in North Carolina, from a plant of *Abelia* 'Little Richard'.

**Protection Status:** Plant Patent Applied For

**Hardiness:** USDA Zone 6 to 9

**Bloom:** Light pink buds open to small, white tubular flowers, which persist in fall.

**Foliage:** Leaves are variegated and emerge bright yellow with a light green center in the spring and gradually change to golden yellow with a green center in the summer. Fall foliage is a combination of golden yellow, bright orange, and fiery red. Foliage does not scorch or bleach in full sun. Stem color of new growth is bright red.

**Habit:** Low, mounded, compact, extremely dense. 2 ft to 2½ ft tall by 3 ft to 3½ wide.

**Propagation:** Roots easily from softwood cuttings. 1000–1500 ppm K-IBA. License required to propagate.

**Culture:** Full sun to partial shade. Best in full sun. Will tolerate all but heavy, poorly drained soil and extremely high pH. Requires little or no pruning. High fertility increases foliage retention in the winter. Prefers acidic, well-drained, moist soil.

**Use:** Excellent plant for containers, as a low accent plant in the garden and for mass planting.

***Acer tataricum* subsp. *ginnala* ‘Ruby Slippers’**

The most outstanding characteristic of this deciduous small shade tree is the brilliant ruby-red samaras that hold their intense red color longer than the species and/or other cultivars of *A. tataricum* subsp. *ginnala*. In mid-summer when seed are turning brown on other *A. tataricum* subsp. *ginnala*, ‘Ruby Slippers’ trees are abundant with brilliant red samaras, creating the illusion of red flowers and often eliciting the question, “What is that tree?”

This tree was discovered in a Princeton Nurseries seedling block in 1990 and was first selected for its straight stem and dense growth habit. Because *A. tataricum* subsp. *ginnala* as a species tends to be multistem and exhibit variable growth habit, the search was on for a nice single-stem tree with the cold hardiness and durability of an *A. tataricum* subsp. *ginnala*. Later, the selection was “rediscovered” due to the intensity of the red samaras and the fact that the color persisted longer than other *A. tataricum* subsp. *ginnala*. This selection was then named and introduced in the summer of 2004 after being propagated and observed for 14 years.

Fall color is equally intense, with a powerful mixture of red and orange. This tree is hardy in Zones 3–8 and tolerates a wide range of environmental conditions including drought, compacted soil, and air pollution, which is typical of the species. Mature size: 20 ft × 20 ft. Bud-grafting in mid to late August has proven to be the most efficient method of asexual propagation here in the Northeast.

***Andropogon gerardii* Silver Sunrise™ big bluestem**

2006 GreatPlants® introduction. Outstanding colorful cultivar selected from *Andropogon gerardii* ‘Champ’ by Dr. Donald Steinegger of the University of Nebraska Horticulture Department and evaluated and introduced by the GreatPlants program of Nebraska. Its showy blue basal foliage with rich purple fall color is contrasted with wide golden bands in the flowering culms. Zone 4.

***Baptisia* ×*variicolor* ‘Twilite Prairieblues’ PPAF Twilite Prairieblues false indigo**

An extremely robust and vigorous bi-color *Baptisia* selected from a controlled cross of *B. australis* × *B. sphaerocarpa* conducted by Dr. Jim Ault at the Chicago Botanic Garden in Glencoe, Illinois. Three-year-old plants produce upwards of 100 flowering stems covered with deep violet-purple flowers highlighted by a lemon-yellow keel. The inflorescences are held above the handsome blue-green foliage and can be up to 32 inches long. This selection began flowering its 2nd year in the ground (from a 4-inch pot). Blooms are long lasting beginning in late May and continuing through the first few weeks of June. The flowers fade to an attractive violet-purple. Mature plants measure 3½ to 5 ft tall and 4 to 5 ft wide. Zone 4–9.

***Buxus* ‘Wilson’, Northern Charm™ boxwood**

Selected by Wilson Nurseries, Inc., Hampshire, Illinois, for its excellent cold hardiness, a compact, oval-rounded habit, delicate foliage, and good growth rate. The semi-glossy, emerald-green foliage develops an appealing bluish cast during the growing season, changing to rich, deep black-green during winter. The elegant texture, color, and habit of this selection make it an outstanding choice for traditional formal hedges and border plantings. Zone 4b–9.

***Caragana microphylla* 'Mongolian Silver Spires'**

Sparkling ferny silver leaves, narrow upright habit on this 8–9 ft xeric shrub. Large yellow flowers produce red seedpods. Selected from seed from a Mongolian steppe. For hedge or low windbreak; somewhat spiny. Future GreatPlants designee. Zone 3.

***Cercis canadensis* 'Hearts of Gold' PPAF**

This is the first known, gold-foliaged *Cercis* for the U.S.A. market. New leaves emerge red then turn to gold and, where leaves are shaded by others, will turn to green. Hearts of Gold™ redbud offers a perfect way to darken the grayest day and provides a riot of color in early spring flower, even before foliage emerges. Tiny lavender-purple redbud blooms are early harbingers of spring in the landscape. And in summer, the gold foliage is burn-resistant even in full sun.

A U.S.A. native, this gold redbud is as vigorous as green types and will grow to 10 ft in the first 5 years. At maturity it will reach 15 ft tall by 18 ft wide, making it perfect for hedges or as a specimen planting.

**Hardiness:** Zone 4 to 10, to be tested. Definitely 5 to 9.

**Bloom:** Clusters of sweet pea blooms, bright lavender purple, early spring.

**Foliage:** Intense golden color, heart-shaped. New growth is red, shaded leaves turn green.

**Habit:** Vase-shaped, pendulous.

***Clematis* 'Center Star' PPAF**

'Center Star' clematis is a nonvining herbaceous perennial developed from a cross between *C. integrifolia* and *C. hexapetala*. It has the blue flower color from its female parent and upright facing flowers from the male parent. It has an upright growth habit growing to a height of 30 inches but the stems are weak and the plant falls without support. It produces a heavy crop of 1½-inch flowers beginning in mid June and lasting to late August. Flowers are sterile. It is an attractive plant in the perennial garden if supported by a wire cage or can be effective if planted above a wall and the foliage allowed to cascade over the top. Foliage is a dark glossy green. Hardy to Zone 4.

***Clematis* 'Pixie Parasols' (Atragene Group) [syn. *P. columbiana* var. *tenuiloba*] (dwarf Rocky Mountain clematis, matted purple virgin's bower)**

Plantsman Claude Barr said in *Jewels of the Plains*, "The prize rock garden clematis of the West, perhaps of the world." It covers its fine-dissected, low-growing, nonclimbing foliage with beautiful bluish purple umbrellas in late spring and later with interesting seed heads. Some reblooming in fall. Makes a high-class groundcover. For sun to part shade. Zone 3.

***Cornus alternifolia* 'Wstackman' PP# 11,287, Golden Shadows® pagoda dogwood**

A new gold-variegated form of pagoda dogwood discovered by Walter Stackman. The large leaves are decorated with a wide golden-yellow band at the margin. The growth is substantially stronger than *C. alternifolia* 'Argentea'. Propagation is by softwood cuttings or by grafting.

***Cornus kousa* var. *chinensis* 'Madison' PP# 16129, Crown Jewel™ Chinese dogwood**

*Cornus kousa* var. *chinensis* 'Madison' is a new selection introduced by Brotzman's

Nursery, Inc., for its unique characteristic of the new leaves changing to yellow and red in early August and finally a rainbow of colors in October.

Madison dogwood is a seedling out of the Milky Way strain that was observed at Brotzman's Nursery approximately 12 years ago. The plant is very vigorous, producing thick, green leaves throughout the spring and early summer. Growth often times continues well into the summer months or resumes, after a short pause, in August or September. In fact, vigorous, young growth appears to be essential to promote the development of the yellow and red colors. Conversion from green leaves to yellow and red typically involves only 1–5 of the most terminal whorls on any given branch, and may include all or only a small portion of the plant. Coloration appears to be tied to a gradual shortening of day length, as well as proper nutrition, temperature, and vigor. Change in coloration does not cause drying or degradation of the leaf itself, and fresh, new growth often continues during this time period. Coloration may include all or part of the entire leaf surface and veins.

Flowering characteristics are white and typical of the specie, although flowers with extra bracts seem to be produced with greater frequency of occurrence than is expected in the specie as a whole. Bracts may be held until fruit are mature. In addition, fruit are occasionally produced that seem fused together, usually with parts of the bracts attached. 'Madison' has been propagated by grafting, cuttings, and budding. The unique summer color change is not always seen in young plants, and further studies are being conducted to confirm that the desired characteristics do appear and repeat after a few years. Until this is confirmed, licensed propagators should segregate nontypical plants. Late summer coloration has not been observed in plants grown in Oregon, suggesting a temperature (hot) link for optimum desired expectations. In Tennessee the desired color change appears in about 50%–70% of 1-year buds. About 70%–80% of older plants in Ohio display this characteristic.

U.S.A. Plant Patent protection has been sought for this plant, and it is our intent to market it under the trademark name of Crown Jewel. Licensed growers are being accepted, and propagating material for trial has been widely distributed. COPF protection will most likely be sought.

### ***Corylus* 'Red Majestic'<sup>PPBR</sup>, red-leaf contorted filbert PPAF**

'Red Majestic' is a new contorted filbert with reddish-purple leaves. In the spring the entire plant leafs out a vibrant red and darkens as the season progresses. The older leaves transform to green but the new growth continues to flush red. A cross between *C. avellana* 'Contorta' and *C. maxima* var. *purpurea* developed in Germany. Propagation is by grafting or by bed stooling.

### ***Echinacea* 'CBG Cone2' PPAF, PBRAF, Pixie Meadowbrite™ coneflower**

A dwarf pink selection of a cross between *Echinacea tennesseensis*, *E. angustifolia*, and *E. purpurea*. The plant was bred and selected by Dr. Jim Ault of the Chicago Botanic Garden. A true dwarf, each plant grows to 18 inches tall and spreads 20 to 24 inches wide. The compact yet strong stems branch naturally to produce an abundance of bright pink flowers throughout the late summer, attracting butterflies and gardeners alike. A very drought tolerant selection that propagates and grows very easily. Zone 4–9.

### ***Echinacea purpurea* 'Prairie Giant'**

Huge flowers with narrow pink petals spanning 6–9 inches on 30–40 inch stalks. Beautiful rich dark green basal leaves up to 24 inches long and 4½ inches wide. Has

been happy and long flowering in our Zone 4 garden for 10+ years. Zone 4.

***Fargesia rufa* 'Rufa', GREEN PANDA™ bamboo**

Maximum height: 10 ft.

Maximum culm diameter: 0.8 inches.

Minimum temperature: -15 °F Zone 5–8.

Sun: Full sun to full shade.

This clumping, non-invasive bamboo has enormous potential in landscapes across North America and Canada. Grows into a large clump (6–8 ft wide) with arching stems. Cultivated as *Fargesia* 'Rufa' in Europe for several years, Oprins Plant NV received a new plant introduction award at Boskoop in Holland for this form in 2003. Subsequently, it was introduced into the U.S.A. in 2003 as Green Panda™ bamboo. From Gansu, China.

***Fargesia robusta* 'Pingwu', GREEN SCREEN™ bamboo**

Maximum height: 18 ft.

Maximum culm diameter: 0.8 inches.

Minimum temperature: -5 °F Zone 6–8.

Sun: Full sun to partial shade.

A clumping bamboo perfect for use as a hedge or screening plant, with the great benefit of its non-invasive root system and robust size. It has been cultivated as *Fargesia robusta* 'Pingwu' in Europe for several years. It is very upright, with persistent culm sheaths that are white, densely covered with hair. Its leaves are longer when compared to the type species and to the form 'Wolong' which has much broader leaves and is less cold hardy. From Szechuan, China.

***Fargesia angustissima* 'Oprin's Selection', GREEN JEWEL™ bamboo**

Maximum height: 16 ft.

Maximum culm diameter: 0.8 inches.

Minimum temperature: 5 °F Zone 7–8.

Sun: Partial shade.

Graceful clumping bamboo with narrow leaves on arching stems. Makes a beautiful potted plant or specimen in the garden. Not as cold hardy as some temperate *Fargesia*, but very attractive and worthy of garden use in areas such as the Pacific Northwest and the Carolinas. Clumping, non-invasive. From Szechuan, China.

***Fargesia* sp. 'Jiuzhaigou', RED PANDA™ bamboo**

Maximum height: 18 ft.

Maximum culm diameter: 0.8 inches.

Minimum temperature: -15 °F Zone 5–8.

Sun: Partial shade.

Beautiful clumping bamboo with very small delicate leaves. Overall form is very upright, perfect for hedges and screens. Culms develop color with sun exposure, showing green, gold and burgundy all on the same plant. Clumping, non-invasive. From Szechuan, China. Clone selected by Jan Oprins.

***Fargesia scabrada* 'Oprin's Selection', ASIAN WONDER™ bamboo**

Maximum height: 18 ft.

Maximum culm diameter: 0.8 inches.

Minimum temperature: -10 °F Zone 5–8.

Partial shade.

Fantastic clumping bamboo with very narrow leaves and graceful appearance. New shoots covered in red hairs. Stems show great color, with orange culm sheaths and steely-blue new culms. Culms mature to olive green. Clumping, non-invasive. From Gansu, China.

***Hamamelis virginiana* ‘Harvest Moon’**

An exciting introduction discovered by Broken Arrow Nursery as a suckering understock on an established witch hazel specimen growing in a client's garden. ‘Harvest Moon’ has attractive, burgundy-flushed new growth that matures to dark green. In late fall, plants offer numerous clusters of large, lemon-yellow flowers that are closely spaced along the branches. The overall effect is a much showier display than is common for the species. In our trials, plants have flowered up to 2 weeks later than the species and have consistently dropped their foliage prior to flowering. Under cultivation, plants are vigorous growers and assume an upright vase-shaped habit maturing 15–18 ft tall in 15 years. Plants can be successfully propagated by stem cuttings and have consistently rooted in much higher percentages than several other *H. virginiana* selections.

***Hydrangea paniculata* ‘Bulk’ PPAF, Quick Fire™ hydrangea**

An extremely early blooming hydrangea noted for its dark pink coloration in summer and fall. The blooms appear in June and begin to change to pink before other selections begin to bloom. It is noted for having compact branching, strong stems, and numerous flower heads. Developed by Mark Bulk of Boskoop, Netherlands. Propagation is by softwood cuttings.

***Hydrangea paniculata* ‘DVPpinky’, PPAF Pinky Winky™ paniced hydrangea**

A new paniced hydrangea noted for its strong upright red stems, large conical blooms, and the intense reddish-pink coloration of the flowers in late summer and autumn. Developed by Johan Van Huylenbroeck of Department of Plant Genetics and Breeding (DvP) in Belgium. Propagation is by softwood cuttings.

***Kalmia latifolia* ‘Firecracker’**

A 5th-generation cross-hybridized by Richard A. Jaynes of Broken Arrow Nursery. Notable parentage includes the *Kalmia latifolia* selections ‘Carol’, ‘Sharon Rose’, and ‘Sarah’. Plants offer brilliant, deep-red flower buds that open near white and age to pale pink. The overall effect is a striking, bicolor display of red-budded and white open flowers. This floral affect, combined with the glossy, dark green foliage and excellent disease resistance make it a promising alternative to ‘Olympic Fire’ and other red-budded cultivars. Plants are more compact than the species maturing approximately 4 ft × 4 ft in 10 years under normal garden conditions.

Breeder requests a voluntary royalty of 15 cents for each plant propagated and sold.

**Propagation:** Semi-ripe cuttings. License required for propagation.

**Culture:** Well-drained soils in full sun or partial shade. Drought tolerant.

***Physocarpus opulifolius* Center Glow™ ninebark**

Center Glow™ ninebark was selected from a population of seedlings resulting from a controlled cross between *Physocarpus opulifolius* ‘Diabolo’<sup>PBR</sup> and *P. opulifolius* ‘Dart’s Gold’. It was selected for its very attractive foliage that emerges a rosy-red color with a yellow-green blotch at the base. As the foliage matures, it loses the blotch and darkens in color to dark, reddish brown. The plant is a rapid grower



reaching a height of 6–8 ft and width of 4–6 ft. Flower buds are pale pink opening to small white flowers in clusters 1–2 inches wide. Developing seed heads are red, turning to brown as they mature. Plants respond very favorably to renewal pruning. New shoots can be cut and used in flower arrangements.

### ***Pinus sylvestris* 'Slim Jim'**

The 'Slim Jim' Scotch pine was found in 1986 as a chance tree growing in a Christmas tree plantation of Musser Forests in Indiana, Pennsylvania. It was among other trees that had been harvested for 2 or 3 years at the end of the rotation.

This particular tree was 4 ft tall and only 1 ft wide with no obvious shearing or trimming that was ever done on it. Another item of interest is that the terminal and other branches end with a tuft of small needles in a bunch with no bud visible.

This tree was transplanted to a safe location and propagated by grafting on *P. sylvestris* and *P. thunbergii*. All grafts seem to be compatible with the understock and come true to type and growth habit without staking. The original tree is now 8–9 ft tall after approximately 25 years. Some others that were grafted have gone to about 12 ft.

This selection has also been tested for winter hardiness and has survived -25 °F with only slight needle burn on some tips.

There also appears to be a certain amount of disease resistance, because other *P. sylvestris* have died of needlecast disease in the area from two successive wet growing seasons. This selection has held good color and foliage with no fungicide applications.

This tree is not patented and has been released to other collectors and growers for a number of years under the 'Slim Jim' name. This tree would make a beautiful addition to any landscape.

### ***Pyrus Silver Ball*<sup>™</sup> pear**

Silver Ball<sup>™</sup> pear is a dense, round-headed small tree maturing at a height of 10–12 ft. It has very attractive silvery-green leaves. The small white flowers emerge after the foliage in spring. The 1/2-inch diameter fruit turn light brown when mature. Plant is hardy to Zone 4. It is very resistant to fireblight. The plants main attribute is its dense compact habit and silvery foliage. Fall color is insignificant and the leaves are held late in the season. It makes an excellent specimen plant in the landscape. It was selected by the Landscape Plant Development Center from an open-pollinated hybrid of *Pyrus calleryana* × *P. betulifolia*. Male parent is unknown. The female parent was growing amongst populations of hybrids with many different *Pyrus* species in their background.

The plant is a slow grower. It can best be produced by grafting on a standard to produce a higher head more quickly.

### ***Sedum tatarinowii* 'Mongolian Stardust'**

A 2004 GreatPlants introduction (syn. *Hylotelephium tatarinowii*) Only 5–8 inches tall and up to 12 inches wide, it is a clumper with a large rootstock. The glaucous dentate leaves will develop rosy pink late summer and fall color. The clusters of dainty flowers are white to pink with large purple anthers. This charmer is best suited for the rockery, trough or raised beds and requires good drainage. Collected by Harlan Hamernik in northern Inner Mongolia. Zone 3. Ten cents from the sale of each plant goes to the GreatPlants group to help fund more plant exploration and breeding.

*Thermopsis chinensis*

This is a species — native to a few locations in central and eastern China — that has been mistakenly confused with *T. lanceolata*, a stoloniferous species with a much wider distribution across China, Russia, and Kazakhstan. The very attractive thick grayish-purple flower buds of *T. chinensis* emerge in mid-March coinciding with the blooms of galanthus, species crocus, and hamamelis cultivars. The emerging buds may still only be 6 inches high a week later and will slowly unfurl coinciding with blooms of hellebores, epimediums, *Primula kisoana*, *Cardamine (Dentaria) diphylla*, *Iberis sempervirens*, and *Veronica pedicularis* ‘Georgia Blue’. The lovely, frost-resistant soft-yellow flowers will be fully open a week or two before redbuds and dogwoods. *Thermopsis chinensis* grows to 50 cm and has small obovate leaves 2.5 cm long, 0.6–1 cm wide and has erect, linear seedpods.

---

## Softwood Cutting Propagation of Native Lauraceae (*Lindera benzoin* and *Sassafras albidum*) as Alternatives to Invasive Horticulture Plants<sup>®</sup>

Jenna Sicuranza, Nick Castrataro, Bill Johnson, and Brian Maynard

University of Rhode Island, Department of Plant Sciences, Kingston, Rhode Island 02881 U.S.A.

### INTRODUCTION

The topic of invasive plants is hotly debated in horticulture. Plant nurseries and horticultural institutions are often identified as sources for a high percentage of invasive plants. Enormous pressure is put on nurseries to discontinue sales of certain high-profile invasive plants, many of which represent large portions of plant sales. In some New England states legislation prohibiting sales of certain invasive plants has been enacted; in others, voluntary action is encouraged. In either case, the potential economic loss to the industry is great. Therefore, the production of non-invasive alternatives to invasive plants is a priority. While native plants are not the only alternatives, they do offer other associated benefits, such as attracting native wildlife. In addition, native plants are becoming more popular with consumers and represent a growing niche market. Native plants have been so far relatively unexplored by the industry; exploring their horticultural possibilities offers many opportunities to bring new plants to the market. Two native plants in the Lauraceae family have potential as native alternatives. *Lindera benzoin* (L.) Bl., spicebush, has been suggested as an alternative to *Euonymus alatus* (winged euonymus or burning bush). While *Sassafras albidum* (Nutt.) Nees., sassafras, has not been suggested as an alternative, it has potential to replace invasive trees such as *Acer platanoides* (Norway maple). Both *L. benzoin* and *S. albidum* are produced by the industry, but only by seed propagation. Vegetative propagation, such as softwood cuttings, would allow for cultivar production of these plants, increasing their economic value. Cutting propagation of both plants has shown to be possible, but not worth the effort due to very low rooting percentage. Our goal is to improve the vegetative propagation of these species, to promote more cultivar production, and increase their economic value to the nursery industry.

*Thermopsis chinensis*

This is a species — native to a few locations in central and eastern China — that has been mistakenly confused with *T. lanceolata*, a stoloniferous species with a much wider distribution across China, Russia, and Kazakhstan. The very attractive thick grayish-purple flower buds of *T. chinensis* emerge in mid-March coinciding with the blooms of galanthus, species crocus, and hamamelis cultivars. The emerging buds may still only be 6 inches high a week later and will slowly unfurl coinciding with blooms of hellebores, epimediums, *Primula kisoana*, *Cardamine (Dentaria) diphylla*, *Iberis sempervirens*, and *Veronica pedicularis* ‘Georgia Blue’. The lovely, frost-resistant soft-yellow flowers will be fully open a week or two before redbuds and dogwoods. *Thermopsis chinensis* grows to 50 cm and has small obovate leaves 2.5 cm long, 0.6–1 cm wide and has erect, linear seedpods.

---

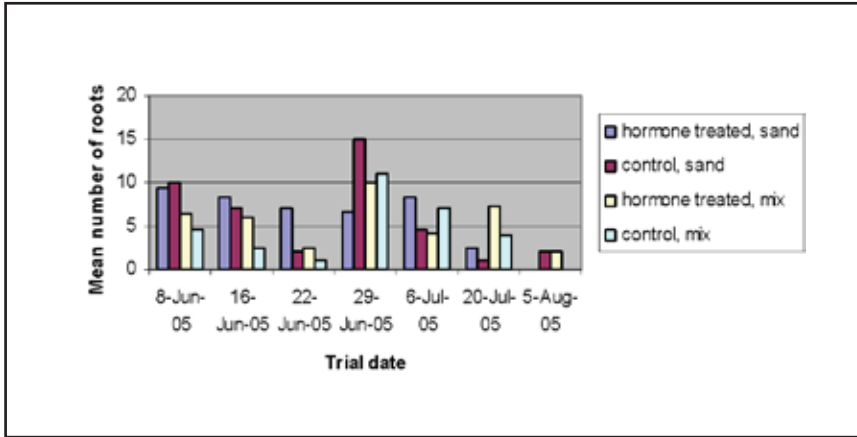
## Softwood Cutting Propagation of Native Lauraceae (*Lindera benzoin* and *Sassafras albidum*) as Alternatives to Invasive Horticulture Plants<sup>®</sup>

Jenna Sicuranza, Nick Castrataro, Bill Johnson, and Brian Maynard

University of Rhode Island, Department of Plant Sciences, Kingston, Rhode Island 02881 U.S.A.

### INTRODUCTION

The topic of invasive plants is hotly debated in horticulture. Plant nurseries and horticultural institutions are often identified as sources for a high percentage of invasive plants. Enormous pressure is put on nurseries to discontinue sales of certain high-profile invasive plants, many of which represent large portions of plant sales. In some New England states legislation prohibiting sales of certain invasive plants has been enacted; in others, voluntary action is encouraged. In either case, the potential economic loss to the industry is great. Therefore, the production of non-invasive alternatives to invasive plants is a priority. While native plants are not the only alternatives, they do offer other associated benefits, such as attracting native wildlife. In addition, native plants are becoming more popular with consumers and represent a growing niche market. Native plants have been so far relatively unexplored by the industry; exploring their horticultural possibilities offers many opportunities to bring new plants to the market. Two native plants in the Lauraceae family have potential as native alternatives. *Lindera benzoin* (L.) Bl., spicebush, has been suggested as an alternative to *Euonymus alatus* (winged euonymus or burning bush). While *Sassafras albidum* (Nutt.) Nees., sassafras, has not been suggested as an alternative, it has potential to replace invasive trees such as *Acer platanoides* (Norway maple). Both *L. benzoin* and *S. albidum* are produced by the industry, but only by seed propagation. Vegetative propagation, such as softwood cuttings, would allow for cultivar production of these plants, increasing their economic value. Cutting propagation of both plants has shown to be possible, but not worth the effort due to very low rooting percentage. Our goal is to improve the vegetative propagation of these species, to promote more cultivar production, and increase their economic value to the nursery industry.



**Figure 1.** Mean number of roots per rooted cutting of *Lindera benzoin* softwood cutting, Summer 2005.

**Table 1.** Rooting percentage, all cuttings.

Trial Date	<i>Lindera benzoin</i>				<i>Sassafras albidum</i>			
	MIX		SAND		MIX		SAND	
	hormone	control	hormone	control	hormone	control	hormone	control
8-Jun-05	100	100	100	100	0	0	0	50
16-Jun-05	86	100	100	100	43	100	71	50
22-Jun-05	86	50	71	50	0	50	0	0
29-Jun-05	100	100	86	100	0	0	0	0
6-Jul-05	100	100	100	100	14	0	0	0
20-Jul-05	86	50	71	50	0	0	0	0
5-Aug-05	43	0	0	50	0	0	0	0

## MATERIALS AND METHODS

Seven softwood cutting trials were done between 8 June 2005 and 5 Aug. 2005. In each trial, 18 stem cuttings of each species (*L. benzoin* and *S. albidum*), 8 to 13 cm in length, were collected from mature plants in natural areas around The University of Rhode Island Agricultural Experiment Station. Fourteen cuttings were treated with Hormodin #2 (0.3% IBA). The remaining four cuttings received no hormone treatment (control). Cuttings were stuck individually in Anderson bands (Anderson Die & Manufacturing, Portland, Oregon) filled with either sand or a 4 perlite : 1 peat (v/v) mix. Cuttings were placed outside in a shade house (50% shade) under mist (20 sec every 10 min from 0700 to 1900 h) with overhead irrigation (30 min every day) in Kingston, Rhode Island (41°29'N, 71°31'W). All trials were harvested between 19 Sept 2005 and 23 Sept 2005. Rooting percentage, root number, and root length were measured. Note: Hardwood cuttings were collected in Spring

2005 and treated as described above, but no rooted cuttings were produced. Root cutting propagation was also done (Winter 2004–2005), but results were poor.

## RESULTS AND DISCUSSION

Cuttings of *S. albidum* rooted sporadically (Table 1). Those taken on 16 June rooted the best, suggesting a seasonal factor. Of these cuttings, mean root number per rooted cutting was higher for cuttings in sand and was unaffected by hormone treatment (data not shown). Cuttings of *L. benzoin* rooted more easily. Rooting percentage for hormone-treated *L. benzoin* cuttings ranged from 71 to 100, with the exception of cuttings taken on 5 Aug. 2005, which had not rooted, by mid September (Table 1). August may be too late in the season to successfully root *L. benzoin* cuttings. In general, hormone treatment had little effect on rooting percentage, but increased root numbers (Fig. 1). In general, cuttings of *L. benzoin* rooted in sand had more roots per rooted cutting than those rooted in peat-perlite. The vegetative propagation of *L. benzoin* is easy enough to permit selection of superior cultivars.

---

## Propagation of Woody Plants Through “Long” Cuttings®

**Jelle Hiemstra and Bart van der Sluis**

Applied Plant Research, Nursery Stock Research Unit (PPO-Bomen), P.O. Box 118, 2770 AC Boskoop, The Netherlands

### OBJECTIVE

Development of a quick method for vegetative propagation with a higher rate of rooting than the present methods.

### PROBLEM

To ensure uniformity, many street trees in the Netherlands are vegetatively propagated. However, success rates of the methods in use depend on the species being propagated, and several problems may occur such as:

- Difficulty in propagating certain species through rooting of cuttings.
- Slow regrowth of rooted cuttings.
- Occurrence of delayed incompatibility in certain combinations of rootstock and scion after propagation by chip budding or grafting.

Especially for research on *Acer platanoides* (propagation of *Verticillium*-resistant rootstock selections) and for *Quercus frainetto* (to overcome rootstock-scion incompatibility) we needed a reliable method to root cuttings. Common methods do not work well for these two species, so a method using long leafy cuttings (“Spethmann method”) was tested.

### APPROACH

- Greenhouse compartment with high humidity (95%–100%) atmosphere (PlantFog system) (Fig. 1).
- Several series of rooting rose (*Rosa*) cuttings of 60–80 cm length (2002–2003).

2005 and treated as described above, but no rooted cuttings were produced. Root cutting propagation was also done (Winter 2004–2005), but results were poor.

## RESULTS AND DISCUSSION

Cuttings of *S. albidum* rooted sporadically (Table 1). Those taken on 16 June rooted the best, suggesting a seasonal factor. Of these cuttings, mean root number per rooted cutting was higher for cuttings in sand and was unaffected by hormone treatment (data not shown). Cuttings of *L. benzoin* rooted more easily. Rooting percentage for hormone-treated *L. benzoin* cuttings ranged from 71 to 100, with the exception of cuttings taken on 5 Aug. 2005, which had not rooted, by mid September (Table 1). August may be too late in the season to successfully root *L. benzoin* cuttings. In general, hormone treatment had little effect on rooting percentage, but increased root numbers (Fig. 1). In general, cuttings of *L. benzoin* rooted in sand had more roots per rooted cutting than those rooted in peat-perlite. The vegetative propagation of *L. benzoin* is easy enough to permit selection of superior cultivars.

---

## Propagation of Woody Plants Through “Long” Cuttings®

**Jelle Hiemstra and Bart van der Sluis**

Applied Plant Research, Nursery Stock Research Unit (PPO-Bomen), P.O. Box 118, 2770 AC Boskoop, The Netherlands

### OBJECTIVE

Development of a quick method for vegetative propagation with a higher rate of rooting than the present methods.

### PROBLEM

To ensure uniformity, many street trees in the Netherlands are vegetatively propagated. However, success rates of the methods in use depend on the species being propagated, and several problems may occur such as:

- Difficulty in propagating certain species through rooting of cuttings.
- Slow regrowth of rooted cuttings.
- Occurrence of delayed incompatibility in certain combinations of rootstock and scion after propagation by chip budding or grafting.

Especially for research on *Acer platanoides* (propagation of *Verticillium*-resistant rootstock selections) and for *Quercus frainetto* (to overcome rootstock-scion incompatibility) we needed a reliable method to root cuttings. Common methods do not work well for these two species, so a method using long leafy cuttings (“Spethmann method”) was tested.

### APPROACH

- Greenhouse compartment with high humidity (95%–100%) atmosphere (PlantFog system) (Fig. 1).
- Several series of rooting rose (*Rosa*) cuttings of 60–80 cm length (2002–2003).



**Figure 1.** Cuttings of *Acer platanoides* in a box with substrate (peat) in a glasshouse at 95%–100% humidity.



**Figure 2.** A well rooted cutting of *Quercus robur*.





Figure 3. A poorly rooting cutting of *Acer platanoides*.

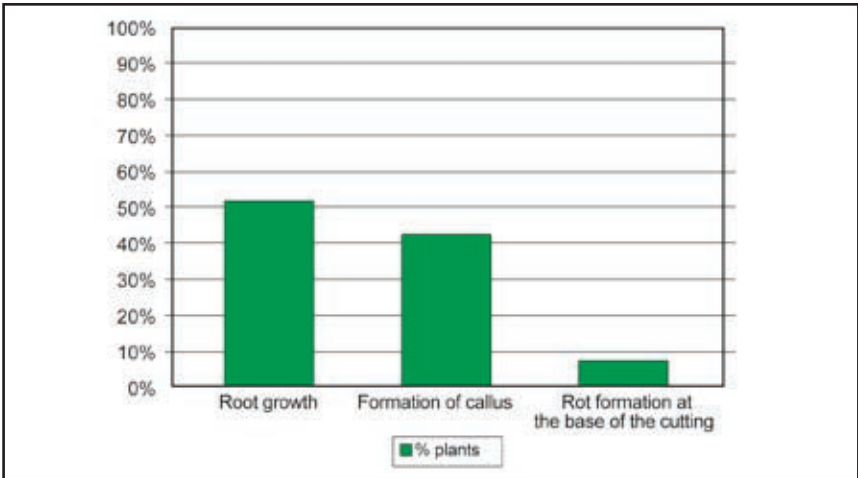


Figure 4. Rooting assessment after 6 to 8 weeks.

- Testing rooting of long cuttings (30–50 cm length) of *Acer platanoides* selections and *Q. frainetto* with *Q. robur* and *Magnolia stellata* as comparison trials in 2004.
- After 6 to 8 weeks rooting percentages were assessed.

## RESULTS

### *Rose.*

- High rooting percentages were possible (up to 85%).
- Moisture content of rooting medium was very important (too high: just one root sprout; too low: formation of callus but no roots).

### *Shade Trees.*

- *Acer platanoides*: Rooting percentage differs with selection (genotype) being propagated; on average 51% rooting was observed (Fig. 2).
- *Quercus frainetto*: No rooting at all.
- *Quercus robur*: Only 25% rooted cuttings (Fig 3).
- *Magnolia stellata*: Very good rooting; up to 85% observed.

## CONCLUSION

Long cuttings may be a way to propagate some of the “difficult” shade tree species. The percentage of success; however, strongly depends on the genotype being used; the results differ between species as well as between individuals within a species (Fig. 4). The method will be further evaluated for *Acer platanoides* in a new trial in 2005.

**Acknowledgement.** This research project was financed by the Dutch Product Board of Horticulture (PT).

# The Development of Verticillium-Resistant *Acer* Rootstocks<sup>®</sup>

**Jelle Heimstra and Bart van der Sluis**

Applied Plant Research, Nursery Stock Research Unit (PPO-Bomen), P.O. Box 118, 2770 AC Boskoop, The Netherlands

## OBJECTIVE

To develop rootstocks for *Acer platanoides* that are resistant to *Verticillium dahliae*.

## PROBLEM

- Verticillium wilt affects many shade trees including *Acer*, *Aesculus*, *Catalpa*, *Fraxinus*, *Prunus*, *Robinia*, *Syringa*, and *Ulmus* species.
- Norway maple (*A. platanoides*) is one of the major hosts.
- Young plants in tree nurseries as well as older plants in urban or rural plantings are affected (Fig. 1).

## COOPERATION

- Applied Plant Research, Nursery Stock Unit (PPO-Trees).
- Plant Research International (first phase).
- Dutch Product Board of Horticulture (PT).
- European Union/LNV-DWK (first phase).

## APPROACH

- Methods to select and screen for resistance in young seedlings were developed (1993–1995).
- Large-scale selection in seedling populations of *Acer platanoides* (1995–1998).
- Propagation of selected individuals (1997–2000).
- Testing resistance of new selections in the field (1999–2003).



**Figure 1.** Common ash (*Fraxinus excelsior*) in roadside plantation strongly affected by verticillium wilt.



Figure 2. Single sample of resistant selection.



Figure 3. Seedling tree after infection by *Verticillium dahliae*.

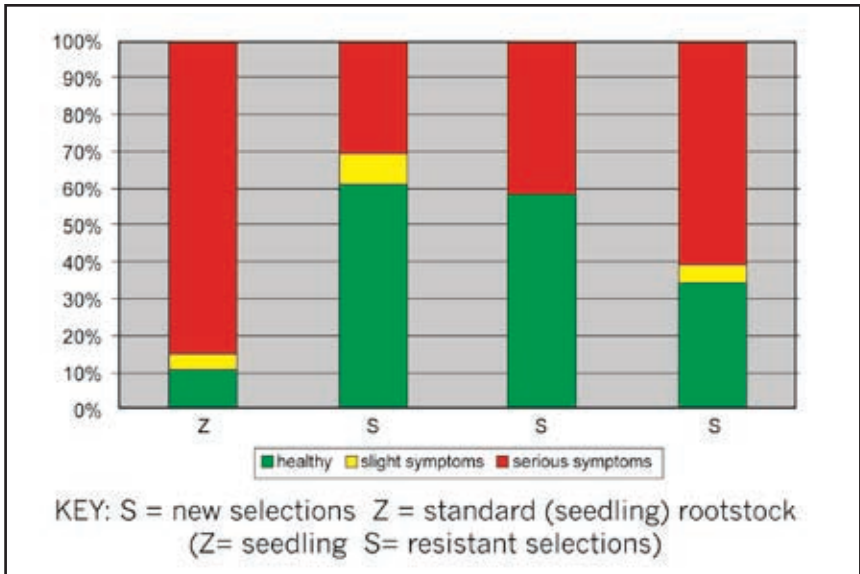


Figure 4. Results of field test of new rootstocks on heavily infected fields.

- Testing best selection as rootstock (2003–2005).

## RESULTS

- From about 20,000 initial seedlings, only some 50 seedlings remained after the first selection.
- After a first round of propagation, about 30 small clones could be tested a second time (Fig. 2).
- Susceptible clones were discarded, and failure to propagate (either by cuttings or in vitro) resulted in about 10 selections that could be tested on a larger scale in the field.
- Some of the best selections performed very well. In a severely infested field, 60% of the individual seedlings of these selections remained healthy, whereas only 10% of the healthy seedling plants (commonly used as rootstock) survived (Fig. 3).
- The best selections now are being developed into verticillium-resistant clonal rootstocks for Norway maple cultivars will become available to growers within the coming years.
- Results of field test of new rootstocks on heavily infected fields is shown in Fig. 4.

Note: See <[www.eu.verticilliumintrees.org](http://www.eu.verticilliumintrees.org)> for more information on verticillium wilts in specimen trees.

---

## Cultivar Trials at Applied Plant Research®

### Margareth Hop

Applied Plant Research, Nursery Stock Research Unit (PPO-Bomen), P.O. Box 118, 2770 AC Boskoop, The Netherlands

## INTRODUCTION

Applied Plant Research in Boskoop (The Netherlands) has several trials of woody plants and herbaceous perennials each year. The aim of these trials is to find out which cultivars are the best for growers and home gardeners. Trials usually run for several years. During this time, the identity of the plant is verified and accurately described, photographed, and documented. Information about differences in cultivation requirements and use is gathered, in many cases in cooperation with researchers in other countries. Besides the ornamental value, we look at ease of propagation, winter hardiness, resistance to pests and diseases, etc. Finally an evaluation committee of nurserymen also judges the plants. The results of the trials and the test committee are published in several Dutch magazines for nurserymen, landscapers, and gardeners.

## TOP SCORERS FROM RECENT TRIALS

*Helenium*. Highest awards in 30 tested cultivars for:

- 'Biedermeier' (unique colouring) (Fig. 1).
- 'Kanaria' (strong and versatile) (Fig. 2).
- 'Rubinzweg' (sturdy, intense colour) (Fig. 3).
- 'Wesergold' (yellow with brown centre, long flowering time).
- 'Goldlackzweg' (red, spotted yellow, sturdy).

- Testing best selection as rootstock (2003–2005).

## RESULTS

- From about 20,000 initial seedlings, only some 50 seedlings remained after the first selection.
- After a first round of propagation, about 30 small clones could be tested a second time (Fig. 2).
- Susceptible clones were discarded, and failure to propagate (either by cuttings or in vitro) resulted in about 10 selections that could be tested on a larger scale in the field.
- Some of the best selections performed very well. In a severely infested field, 60% of the individual seedlings of these selections remained healthy, whereas only 10% of the healthy seedling plants (commonly used as rootstock) survived (Fig. 3).
- The best selections now are being developed into verticillium-resistant clonal rootstocks for Norway maple cultivars will become available to growers within the coming years.
- Results of field test of new rootstocks on heavily infected fields is shown in Fig. 4.

Note: See <[www.eu.verticilliumintrees.org](http://www.eu.verticilliumintrees.org)> for more information on verticillium wilts in specimen trees.

---

## Cultivar Trials at Applied Plant Research®

### Margareth Hop

Applied Plant Research, Nursery Stock Research Unit (PPO-Bomen), P.O. Box 118, 2770 AC Boskoop, The Netherlands

## INTRODUCTION

Applied Plant Research in Boskoop (The Netherlands) has several trials of woody plants and herbaceous perennials each year. The aim of these trials is to find out which cultivars are the best for growers and home gardeners. Trials usually run for several years. During this time, the identity of the plant is verified and accurately described, photographed, and documented. Information about differences in cultivation requirements and use is gathered, in many cases in cooperation with researchers in other countries. Besides the ornamental value, we look at ease of propagation, winter hardiness, resistance to pests and diseases, etc. Finally an evaluation committee of nurserymen also judges the plants. The results of the trials and the test committee are published in several Dutch magazines for nurserymen, landscapers, and gardeners.

## TOP SCORERS FROM RECENT TRIALS

*Helenium*. Highest awards in 30 tested cultivars for:

- 'Biedermeier' (unique colouring) (Fig. 1).
- 'Kanaria' (strong and versatile) (Fig. 2).
- 'Rubinzweg' (sturdy, intense colour) (Fig. 3).
- 'Wesergold' (yellow with brown centre, long flowering time).
- 'Goldlackzweg' (red, spotted yellow, sturdy).





Figure 1. *Helianthus* 'Biedermeier'.



Figure 2. *Helianthus* 'Kanaria'.





Figure 3. *Helenium* 'Rubinzweg'.



Figure 4. *Taxus baccata* 'Standishii'.



Figure 5. *Taxus baccata* 'Repandens'.



Figure 6. *Taxus baccata* 'Micro'.

- 'Zimbelstern' (tall but sturdy, intense ochre yellow colour, brown centre).

***Taxus baccata*. The best from 110 cultivars:**

- 'Fastigiata Rubusta' (very slender, dark green).
- 'Standishii' (slender, yellow variegated, slow growing) (Fig. 4).
- 'Overeynderi' (quite slender, green, very dense, good for hedges).
- 'Semperaurea' (upright, yellow variegated, medium dense).
- 'Repandens' (broadly spreading, green, dense, covers soil well) (Fig. 5).



Figure 7. *Hydrangea macrophylla* 'Lanarth White'.



Figure 8. *Hydrangea macrophylla* 'Kardinal'.

- 'Aldenhams Gold' (yellow variegated dwarf).
- 'Micro' (dark green dwarf) (Fig. 6).
- 'Dovastonianiana' (large green tree).
- 'Dovastonii Aurea' (yellow-variegated tree).

*Taxus × media* 'Nidiformis' (shaped like a nest, green, dense).

*Hydrangea macrophylla*. The best from 200 cultivars:

- 'Madame Emile Mouillère' (hortensia, white).
- 'Mathilde Gütges' (hortensia, light pink/light blue).
- 'Freudenstein' (hortensia, pink/blue).
- 'Grand Chef' (hortensia, pink/blue).
- 'Pia' (hortensia, pink/blue).
- 'Schöne Bautznerin' (hortensia, pink/blue).
- 'Königstein' (hortensia, dark pink/dark blue).
- 'Madame G.J. Bier' (hortensia, red/violet).
- 'Lanarth White' (lacecap, white) (Fig. 7).
- 'Mariesii Lilacina' (lacecap, light pink/light blue).
- 'Taube' (lacecap, pink/blue).
- 'Möwe' (syn. 'Geoffrey Chadbund') (lacecap, dark pink).
- 'Cardinal Red' (syn. 'Kardinal') (lacecap red/violet) (Fig. 8).

In 2005 trials are running on *Buddleja davidii*, *H. paniculata*, *Corylopsis*, *Ceanothus*, *Itea*, *Caryopteris*, and *Weigela*. The results will be available in a few years.

For more information contact: M. (Margareth) Hop, <margareth.hop@wur.nl> or: Applied Plant Research, sector Trees: infobomen.PPO@wur.nl.

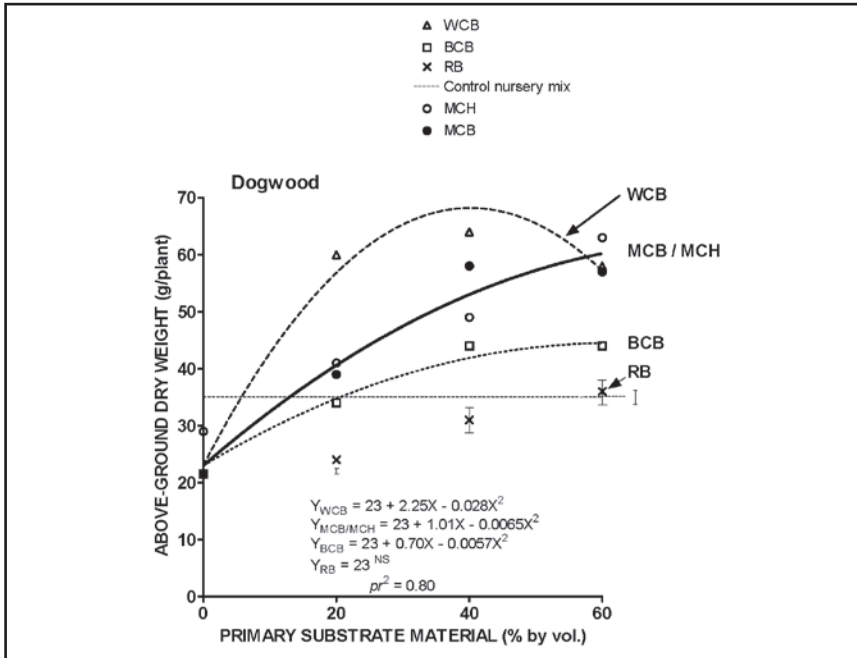
## Use of Paper-Mill Sludges and Municipal Compost in Nursery Substrates<sup>®</sup>

Calvin Chong and Peter Purvis

Department of Plant Agriculture, University of Guelph, Ontario, N1G 2W1 Canada

Municipal compost (Hicklenton et al., 2000) and both raw and composted paper-mill sludges (Campbell et al., 1991; Chong and Cline, 1994) are increasingly being promoted for use in nursery substrates. This study compared raw paper-mill sludge with various composts derived from paper-mill sludges (two sources) and municipal waste (one source), and determined optimum rates of these materials in binary mixtures with bark or hemp chips. The chemical composition of these materials is shown in Table 1.

Silverleaf dogwood (*Cornus alba* 'Elegantissima' syn. 'Argenteo-marginata'), forsythia (*Forsythia × intermedia* 'Lynwood Variety'), and weigela (*Weigela* 'Red Prince') were grown in #2 (6-L) containers filled with 100% bark or bark mixed with 20%, 40%, or 60% by volume each of raw paper-mill sludge (RB group); Bio Soil



**Figure 1.** Aboveground dry weight response of container-grown dogwood to increasing rates of five substrate groups. For significant responses, the regression of each group is represented by a broken curved line or of combined groups by a solid curved line. For non-significant response (RB group), the average  $\pm$  standard error is shown at each rate. The horizontal broken line represents the average aboveground dry weight  $\pm$  standard error of the control nursery mix.  $pr^2$  represents the coefficient of determination after removing replication effects. WCB = Waterdown (paper-mill sludge) compost amended with bark; BCB = Bio Soil (paper-mill sludge) compost amended with bark; RB = raw paper-mill sludge amended with bark; MCH = municipal (leaf and yard waste) compost amended with hemp chips; MCB = municipal (leaf and yard waste) compost amended with bark.

**Table 1.** Chemical analysis<sup>a</sup> of unamended substrate materials before mixing or use.

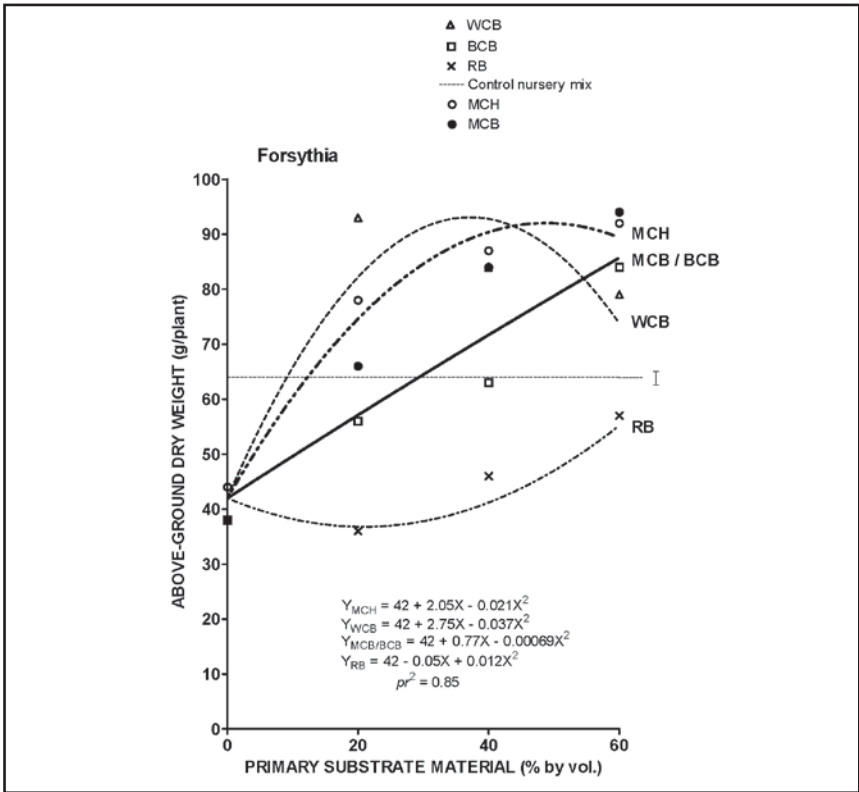
Variable	Recommended values	Primary materials			Secondary materials		
		Raw sludge	Bio Soil compost	Waterdown compost	Municipal compost	Bark	Hemp chips
pH <sup>b</sup>	5.5-7.0	7.9	7.8	8.8	8.1	6.1	7.3
EC (dSm <sup>-1</sup> )	≤1	0.34	0.24	7.38	0.97	0.02	0.30
NH <sub>4</sub> -N <sup>c</sup>	<10	2	11	1	108	1	2
NO <sub>3</sub> -N	100-200	41	1	903	1	1	50
P	6-9	0.1	3	31	1	0.1	11
K	150-200	32	4	2520	131	10	420
Ca	200-300	130	70	61	166	13	33
Mg	70-200	31	10	10	62	2	13
Cl	0-50	49	6	1109	769	3	60
Na	0-50	157	50	860	103	2	2
Fe	0.3-3.0	0.96	0.23	40	0.26	0.93	1.23
Mn	0.3-3.0	0.34	0.10	0.54	0.10	0.11	0.26
Zn	0.3-3.0	0.56	0.13	10	0.13	0.16	0.32
Cu	0.3-3.0	0.11	0.24	2.30	0.24	0.14	0.13

<sup>a</sup>Each datum is an average of two samples.<sup>b</sup>pH and EC measured in 1 substrate : 2 water (v/v) extracts.<sup>c</sup>Concentration of all nutrients expressed in terms of mg·L<sup>-1</sup> measured in saturated medium extracts.

**Table 2.** Correlation between aboveground dry weight (g/plant) of three container-grown nursery species and EC (dS·m<sup>-1</sup>) measured at various intervals during the growing season in waste-derived substrates.

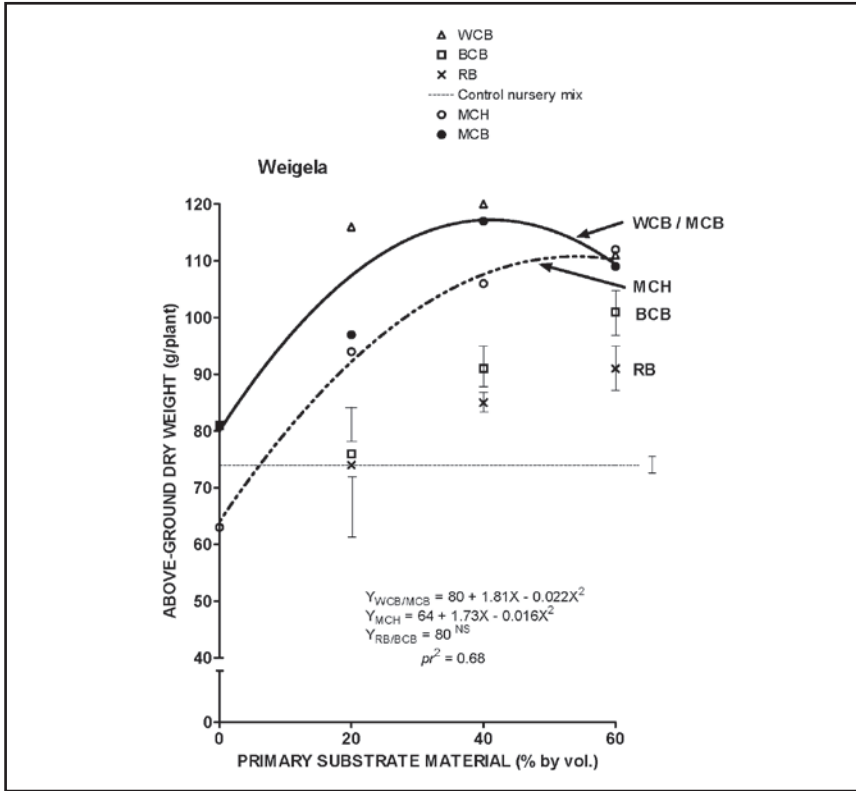
Species	Correlation coefficient, <i>r</i>				
	24 May	19 July	18 Aug.	10 Oct.	Average across dates
Dogwood	0.79**	0.49**	0.56**	0.20	0.66**
Forsythia	0.66**	0.59**	0.62**	0.39	0.69**
Weigela	0.76**	0.66**	0.21	0.43	0.72**

\*\*Significant at *P* < 0.01, n = 21.



**Figure 2.** Aboveground dry weight response of container-grown forsythia to increasing rates of five substrate groups. (See Fig. 1 for legend.)





**Figure 3.** Aboveground dry weight response of container-grown weigela to increasing rates of five substrate groups. (See Fig. 1 for legend.)

compost containing 100% paper-mill sludge (BCB group); Waterdown compost containing 40% paper sludge, 40% chicken manure, and 20% sawdust (WCB group); and municipal compost consisting of leaf and yard waste (MCB group). A fifth substrate group (MCH) consisted of 100% hemp chips or hemp chips mixed with the same rates of municipal compost.

The containers were fertilized with pre-incorporated Nutryon 17-5-12 (17.0N-2.2P-10.0K) controlled-release fertilizer ( $6.5 \text{ kg} \cdot \text{m}^{-3}$ ). Each container received 2 L of hand-applied water immediately after potting and 1-L trickle applied twice daily thereafter. Plants of each species were arranged in a randomized complete block design with four replications and four plants per plot.

Regression analysis indicated that growth among the bark-amended groups was highest for dogwood (Fig. 1) and forsythia (Fig. 2) with WCB, increasing dramatically and peaking at about the 40% rate (68 and 94 g per plant aboveground dry weight, respectively). Growth of these species was intermediate with MCB and BCB and least with RB, increasing to rates  $\geq 50\%$  in these groups. There was no significant response of dogwood to RB. Growth of weigela (Fig. 3) increased equally with WCB and MCB substrates up to about 40% (117 g per plant), but was not



influenced by varying rates of RB and BCB. With the hemp-amended MCH group, growth of all three species increased to rates  $\geq 50\%$  (62, 93, and 116 g per plant for dogwood, forsythia, and weigela, respectively). Growth of the three species over most rates of all substrate groups was similar to, or exceeded that in 8 bark : 1.5 peat : 0.5 topsoil, a proven nursery mix.

Throughout the season, there was no sign of nutrient toxicity or deficiency on any of the plants. Furthermore, chemical analysis (data not shown) indicated that the range in concentrations of individual foliar nutrients within each species was in most cases small or statistically nonsignificant and within sufficiency ranges. Aboveground dry weight of all three species was positively correlated with soluble salts concentrations in the substrates sampled at planting and on other sampling dates during the season (Table 2), suggesting that enhanced growth of plants was related, at least in part, to higher retention or availability of substrate nutrients.

**Acknowledgments.** Environmental Systems; Healthy Futures for Ontario Agriculture; Abitibi Consolidated; Landscape Ontario Horticultural Trades Foundation and Growers' Group; and the National Research Council Canada Industrial Research Assistance Program (IRAP).

#### LITERATURE CITED

- Campbell, A.G., R.R. Engebretson, and R.R. Tripepi.** 1991. Composting of a combined RMP/CMP pulp and paper sludges. *Tappi Journ.* 74:183–191.
- Chong, C., and R.A. Cline.** 1994. Response of container-grown nursery crops to raw and composted paper-mill sludges. *Compost Sci. Util.* 2:90–96.
- Hicklenton, P.R., A.V. Rodd, and P.R. Warman.** 2000. Variations in properties of source-separated municipal solid waste compost have minimal effects on growth and nutrition of container-grown woody ornamental shrub, p. 934–941. In: P.R. Warman and B.R. Taylor, Eds. *Proc. Intl. Composting Symp. (ICS '99)*, Vol. II. CBA Press, Truro, N.S.

## Interspecific Hybridization of a White-Flowered, Cold-Hardy *Alstroemeria*<sup>®</sup>

Elizabeth Kollman and Dr. Mark Bridgen

Cornell University, Department of Horticulture, Ithaca, New York 14853 U.S.A.

*Alstroemeria*, the Inca lily or lily-of-the-Incas, is becoming a popular garden plant in the United States. In past years, the primary interest in *Alstroemeria* has been for its cut flowers. However, recent cold-hardy introductions (U.S.D.A. hardiness Zone 5) have expanded the interest of this colorful plant as a garden perennial throughout the United States. Previously, garden interests were restricted to warmer zones in the southern United States where *Alstroemeria* could overwinter. This research describes a breeding procedure that has been used with the objective to develop a cold-hardy, white-flowered *Alstroemeria*. The interspecific hybrids were bred with the use of in ovulo-embryo rescue. Reciprocal crosses were made between several white-flowered cultivars and the cold-hardy Chilean species, *Alstroemeria aurea* during 2004 and 2005. Ovaries were collected 10–23 days after hand pollination, and their ovules were aseptically excised. Ovules were placed in vitro on 25% Murashige and Skoog (MS) medium under dark conditions until germination. After germination they were then placed on 100% MS medium, and subcultured every 3 to 4 weeks thereafter until they were large enough for rooting. After rooting and acclimation, plants were transferred to the greenhouse. Successful hybrids that were produced in 2004 were evaluated under greenhouse and field trials during 2005, and the number of plants with white-colored flowers was noted. Although certain morphological characteristics indicate if plants are cold hardy, the hybrids will be over-wintered outside in Ithaca, New York (USDA Zone 5) during the next several years to determine winter hardiness.

## The Effects of Nitrogen Level and Mist Frequency on Rooting of Three *Phlox* Species<sup>®</sup>

Sinclair A. Adam Jr.

Ambler College, Landscape Architecture and Horticulture Department & The Center for Sustainable Communities, Temple University, Ambler, Pennsylvania 19002 U.S.A.

Growers and propagators are working to reduce nutrient losses from sites and to improve nutrient use efficiency for reduced environmental impact and for production efficiency (Hartmann, et al., 2000). Woody cuttings in mist systems have demonstrated benefits from the addition of nutrients in the mist, but many herbaceous perennials are undocumented with respect to nutrient requirements in mist systems (Hartmann, et al., 2000; Rowe and Cregg, 2002). *Phlox* species are popular herbaceous perennials typically produced from stem cuttings (Armitage, 1997). *Phlox glaberrima* 'Morris Berd' is a perennial plant of increasing interest, is easy (to moderately easy) to produce from cuttings, and blooms mid-spring to early summer. *Phlox paniculata* 'David' was The Perennial Plant Association's perennial plant of the year in 2002 and is a popular summer-blooming garden phlox with powdery mildew resistance (Perry and Adam, Jr., 1994). *Phlox paniculata* typically takes a slightly longer period to root and is more difficult to root than most other phlox species. *Phlox stolonifera* 'Home Fires', is a popular spring-blooming selection that is easy to root and that will root in a short interval.

Cuttings were selected for uniformity by species from well-developed stock plants and harvested. Cuttings were dipped for 5 sec in Woods Rooting Compound (Earth Science Products Corp., Watsonville, Oregon) at 1000 ppm a.i. (1.03% IBA and 0.66% NAA), and stuck in pre-moistened Sunshine #2 potting medium (Sungro Inc., Bellview, Washington) in an intermittent mist system in the Temple University greenhouse on 28 June 2004. The experiment was set up in a complete randomized block design, and treatment levels of 0, 75, and 150 ppm nitrogen (applied as  $\text{NH}_4\text{NO}_3$ ) were applied by hand to each cell in the flat. Fifteen-milliliter (volume) treatment solutions were applied to each cell, providing for a 10% leachate fraction. Treatment solutions were applied two times per week throughout the experimental period, and mist levels were set at 10-, 20-, and 30-min mist frequencies and 12-sec duration. Greenhouse temperatures were maintained at 24 °C (day) and 15 °C (night) and light ranged from 225  $\mu\text{m}\cdot\text{s}^{-1}\cdot\text{m}^{-2}$  to 622  $\mu\text{m}\cdot\text{s}^{-1}\cdot\text{m}^{-2}$  during the experimental period. After 30 days, the experiment was harvested. Cuttings were measured for leaf chlorophyll level using a Minolta SPAD 502 chlorophyll meter (Minolta) and then removed from the rooting medium. Root number was recorded, as was root length (cm). Roots were separated from shoots and measured for fresh weight and subsequently placed into a drying oven for 48 h at 90 °C. They were then measured for dry weight, and results were recorded. Results of plant measurements were subjected to analysis of variance and regression where applicable.

Cuttings of *P. glaberrima* 'Morris Berd' exhibited significant increase in chlorophyll (SPAD) level with increasing nitrogen treatment level, but the increasing levels were only significant for the 20-min mist frequency. At all treatment levels of N and all mist frequencies, 100% of the cuttings rooted. Fresh weight significantly increased with increasing N treatment level at the 20- and 30-min mist frequencies. For the 10-min mist frequency, numerical gains in fresh weight were observed but

were not significant. Root dry weight was significantly influenced by nitrogen level at the 20-min mist frequency but was nonsignificant for the 10- and 30-min mist frequencies. Root number was not significantly influenced by nitrogen treatment level for any of the three mist frequencies tested. Root length decreased significantly with increasing N treatment level at the 10- and 30-min mist frequencies but was not significant for the 20-min mist frequency. *Phlox paniculata* 'David' cuttings were not significantly influenced by N treatment level for any mist frequency in chlorophyll (SPAD) level. Cuttings at the 10-min mist frequency rooted 100% except for the 0 ppm N treatment level, which rooted at 91.7%. Cuttings at the 20-min mist frequency rooted at 100% for all N treatment levels. Cuttings at the 30-min mist frequency rooted at 91.7% for the 75 and 150 ppm N treatment levels, and 83.3% for the 0 ppm N treatment level. Increasing N treatment level at the 10- and 20-min mist frequencies significantly influenced fresh weight of roots, but gains were not significant at the 30-min mist frequency. Root dry weight only significantly increased with the 10-min mist frequency, and was nonsignificant for the other mist frequencies. Root number and root length were not significantly influenced by N treatment at any mist frequency tested.

Cutting of *P. stolonifera* 'Home Fires' increased in chlorophyll (SPAD) level with increasing N treatment level for all mist frequencies. A 100% rooting rate occurred for all treatment levels at the 10- and 30-min mist frequencies and at 91.7% for all N treatment levels at the 20-min mist frequency. Although these gains were significant for the 10-min and 30-min mist frequencies, gains were nonsignificant for the 20 min. mist frequency. Fresh root weights generally decreased with increasing N treatment level, but this trend was only significant for the 30-min mist frequency. Dry weight of root was not significantly influenced by N treatment. Root number was not significantly influenced by N treatment level. Root length decreased with increasing N treatment level and was significant for the 10- and 30-min mist frequencies.

Nitrogen treatments were successful in increasing leaf chlorophyll levels with *P. glaberrima* 'Morris Berd' and *P. stolonifera* 'Home Fires' but had ambiguous results on *P. paniculata* 'David'. The nitrogen treatments only increased root dry weights with *P. paniculata* 'David' at the 10-min mist frequency and with *P. glaberrima* 'Morris Berd' at the 20-min mist frequency. Nitrogen treatments decreased root length with increasing treatment level for *P. stolonifera* 'Home Fires' and for *P. glaberrima* 'Morris Berd' at the 10- and 30-min mist frequencies. In agreement with the work of Rowe and Cregg, these results indicate little benefit is obtained from additions of nitrogen in intermittent mist systems for the rooting of *Phlox*. Propagators of herbaceous perennials can reduce nitrogen use by avoiding application in mists systems.

## LITERATURE CITED

- Armitage, A.M. 1997. *Herbaceous Perennial Plants: A treatise on their identification, culture, and garden attributes*. 2nd ed., Stipes Pub., Champaign, Illinois.
- Hartmann, H.T., D. Kester, F. Davies, and R. Geneve. 2002. *Plant propagation: Principles and practices*. 7th ed. Prentice Hall Inc., Upper Saddle River, New Jersey.
- Perry, L.P., and S.A. Adam Jr. 1994. 'David' *Phlox*. *HortScience* 29(6):713.
- Rowe, D.B., and B.M. Cregg. 2002. Effects of incorporating controlled-release fertilizer on adventitious rooting and growth of *Artemisia*, *Gaura*, and *Nepeta*. *J. Environ. Hort.* 20:1-6.

## Severe Cutback of Stock Plant Influences Rooting in Shoots of *Quercus bicolor* and *Quercus macrocarpa*®

Naalamle Amissah and Nina Bassuk

Department of Horticulture, Cornell University, 20 Plant Science Bldg., Ithaca, New York, 14853 U.S.A.

This experiment was conducted to determine the effect of severe stock plant cutback on rooting in two oak species *Quercus bicolor* and *Q. macrocarpa*. Field-grown plants were either cutback leaving a 0.04-m (1.6-inch) stump above soil level or left intact (not cutback) ~1.7 m (66.9 inches) tall. Shoots arising from cutback treatments and intact plants were layered using a field layering technique and air layering, respectively. The rooting traits measured in this experiment were rooting percentage and the number of roots per shoot. Results showed significantly higher rooting percentages in layered propagules arising from severely cutback plants in both species (~77% in *Q. bicolor* and ~70% in *Q. macrocarpa*) compared with air-layered shoots arising from intact plants (1% in *Q. bicolor* and 0% in *Q. macrocarpa*). Overall, pre-treatment etiolation increased rooting in shoots arising from cutback stock plants in both species. The results for the average number of roots per shoot mirrored that of rooting.

### INTRODUCTION

The genus *Quercus* has some of the most spectacular shrubs and vigorous growing trees with desired genetic combinations that are of tremendous benefit to both nursery professionals and horticulturists. Unfortunately, the difficulty involved in vegetatively propagating oaks has limited the availability of select hybrids and ecotypes with outstanding characteristics.

Lately, however, vegetative propagation of oaks has seen a promising turn of events with the development of a modified layering technique (Hawver and Bassuk, 2000; Amissah and Bassuk, 2004).

In woody plant species and more so in difficult-to-root plant species, rooting ability has been observed to decrease with increasing stock plant age. In oaks, the juvenile period, which is a period characterized by a plant's inability to flower or be induced to do so even under favorable environmental conditions, has been observed to last 20–30 years (Clark, 1983). However, the decline in rooting ability is noted long before the onset of flowering (end of the juvenile phase), which poses a challenge to the propagation of select woody plant species. This experiment was conducted to investigate the effect of severe cutback of stock plant on rooting in *Q. macrocarpa* and *Q. bicolor*.

### MATERIALS AND METHODS

**Stock Plant Growing Condition and Environment.** On 3 May 2004 field-grown 8-year-old *Q. bicolor* and *Q. macrocarpa* plants of seedling origin were either cutback leaving a 0.04-m (1.6-inch) stump above soil or left intact (for use as air layers). Upon evidence of bud swelling on the cutback stem, half the stumps were etiolated (grown in the dark by inverting a 4.5-gal pot covered with aluminum foil over the stump) and the other half left uncovered, to grow in normal light.

## TREATMENTS

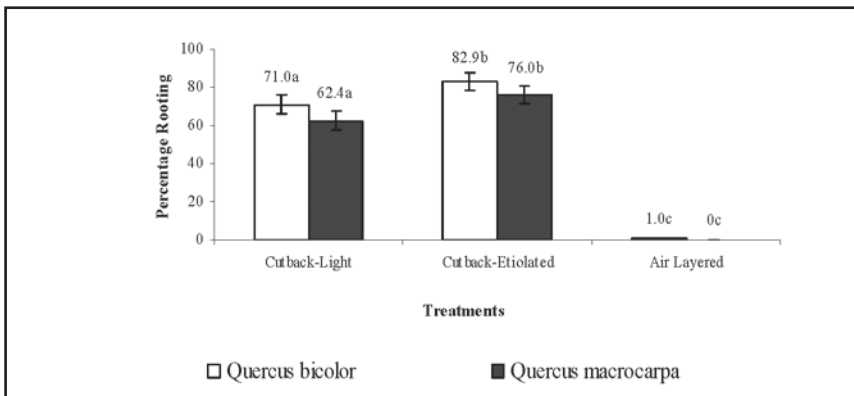
**Field Layering on Cutback Plants.** Upon reaching a height of 0.08–0.1 m, shoots from both etiolated and light treatments had their lower 0.04-m portion painted with 10,000-ppm indole butyric acid (IBA) dissolved in 98% aqueous ethanol. After the IBA solution had dried, a bottomless pot was placed over the stock plant and a lightweight soilless mix (1 peat : 2 perlite, v/v) was filled in around the treated shoot bases. Treated plants were allowed to grow in the field for at least 3 months; during this time, the soilless mix around the treated shoots was kept moist with more soilless mix added as the shoots grew.

**Air Layering of Intact Plants.** The basal 0.05-m portion of softwood shoots arising from the top one-quarter section of intact plants (1.7 m tall) were painted with 10,000 ppm IBA dissolved in 98% aqueous ethanol. After the IBA solution had dried, a ball (~0.06 m in diameter) of moistened peat moss was placed in a 25- $\mu$ m-thick white polythene sheet of dimensions (0.18 m  $\times$  0.18 m) and secured around the treated section using twist ties. The experimental design used was a randomized complete block. Three hundred and seventy-one plants were used in this experiment (145 *Q. bicolor* and 226 *Q. macrocarpa*).

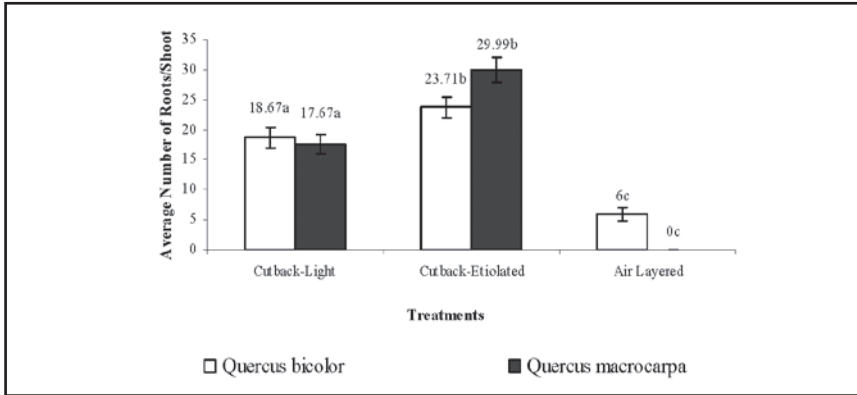
**Parameters Studied.** Three months after the last plant in the field had been treated, the bottomless pot and soilless mix were removed from around the plants and data measured on the number of shoots that rooted per pot as well as number of roots per rooted shoot. The same parameters were also taken for air-layered plants. Rooting data and number of roots per shoot were statistically analyzed using negative Binomial and Poisson regression models (PROC GENMOD) respectively, in SAS version 9.1.3 (2004).

## RESULTS AND DISCUSSION

**Rooting Results.** Propagule origin and species had significant effects on rooting percentage with *p* values of ( $p < 0.003$ ) and ( $p < 0.020$ ), respectively. Rooting increased in cutback plants in both species compared with intact plants (Fig. 1). In addition, significant differences were found between cutback etiolated and cutback light treatments ( $p < 0.001$ ) an indication that etiolation played an important role



**Figure 1.** The effect of propagule origin on rooting in *Quercus bicolor* and *Q. macrocarpa*.



**Figure 2.** The effect of propagule origin on the average number of roots per shoot in *Quercus bicolor* and *Q. macrocarpa*.

in rooting. Overall rooting was better in *Q. bicolor* than in *Q. macrocarpa*, ( $p < 0.01$ ). There was no interaction between the main effects, propagule origin, and species.

**Number of Roots per Shoot (NRPS).** The trend of results for NRPS mirrored that of rooting (Fig. 2). In addition, the NRPS was found to be higher in the cutback treatments (cutback-etiolated and cutback-light) than in intact air layered plants,  $p < 0.001$ .

## CONCLUSION

Although the stock plants used were still in the juvenile phase of development, propagules arising from intact plants rooted poorly. Layered propagules arising from cutback stumps of *Q. bicolor* and *Q. macrocarpa* rooted better than air-layered propagules arising from distal parts of intact stock plants (~1.7 m tall). Etiolation as a pre-treatment aided rooting in cutback plants, which is consistent with the findings of Maynard and Bassuk, 1985.

**Acknowledgements.** The J. Frank Schmidt Charitable Foundation and International Society of Arboriculture TreeFund.

## LITERATURE CITED

- Amissah, N., and N. Bassuk. 2004. Clonal Propagation of *Quercus* spp. using a container layering technique. *J. Environ. Hort.* June 22(2):80-84.
- Clark, J.R. 1983. Age related changes in trees. *J. Arboric.* 9:201-205.
- Hawver, G., and N. Bassuk. 2000. Improved adventitious rooting in *Quercus*, through the use of a modified stoolbed technique. *Comb. Proc. Intl. Plant Prop. Soc.* 50:307-313.
- Maynard, B.K., and N.L. Bassuk. 1985. Etiolation as a tool for rooting cuttings of difficult-to-root woody plants. *Comb. Proc. Intl. Plant Prop. Soc.* 35:448-495.
- SAS Software, version 9.1.3. 2004. SAS Institute, Inc., Cary, North Carolina.



## A Comprehensive *Echinacea* Germplasm Collection Located at the North Central Regional Plant Introduction Station, Ames, Iowa

**Joe-Ann H. McCoy, Mark P. Widrechner, and Jeffrey D. Carstens**

USDA/ARS North Central Regional Plant Introduction Station, G212 Agronomy Hall, Iowa State University, Ames, Iowa 50011 U.S.A.

*Echinacea* is a well-established, high-value crop, both as an ornamental and dietary supplement. A comprehensive collection of *Echinacea* germplasm is currently held at the USDA-ARS North Central Regional Plant Introduction Station (NCRPIS) in Ames, Iowa, and is available via seed distribution for research purposes <<http://www.ars-grin.gov/npgs>>. The NCRPIS's mission includes: (1) The conservation of genetically diverse crop germplasm through collection and acquisition; (2) The conduct of germplasm-related research; and (3) The encouragement of the use of the germplasm collections and associated information for research, crop improvement, and product development.

Representing all nine species collected throughout their respective North American geographic ranges, the *Echinacea* collection includes 159 accessions (Table 1). Extensive morphological characterization data associated with the collection have been assembled and are available to researchers to aid in selection criteria. The collection has been used extensively for various research projects ranging from ornamental breeding studies for the horticulture trade to HPLC analysis of metabolites of interest to the phytopharmaceutical industry.

Germplasm is collected and made available for distribution through a series of steps. Those steps include: (1) Acquisition and exploration; (2) Regeneration and evaluation; (3) Dormancy and germination studies; (4) Seed propagation in field cages with pollinating insects; (5) Harvesting, drying, cleaning, and processing seeds; (6) Long-term storage under controlled conditions; and (7) Distribution for research purposes.

**Table 1.** *Echinacea* accessions conserved at the NCRPIS.

<i>Echinacea</i> taxa	Accessions (no.)	Available accessions
<i>E. angustifolia</i> DC.	6	5
<i>E. angustifolia</i> var. <i>angustifolia</i>	39	34
<i>E. angustifolia</i> var. <i>strigosa</i> McGregor	2	2
<i>E. atrorubens</i> Nutt.	5	5
<i>E. hybrid</i>	2	2
<i>E. laevigata</i> * (F.E. Boynton & Beadle) S.F. Blake	10	*7
<i>E. pallida</i> (Nutt.) Nutt.	45	41
<i>E. paradoxa</i> (Norton) Britton var. <i>neglecta</i> McGregor	5	4
<i>E. paradoxa</i> var. <i>paradoxa</i>	5	5
<i>E. purpurea</i> (L.) Moench	17	10
<i>E. sanguinea</i> Nutt.	9	3
<i>E. simulata</i> McGregor	10	8
<i>E. tennesseensis</i> * (Beadle) Small	4	*4
82% of the collection is available	159	130

\*Federally endangered, requires letter of intent or appropriate permit.

This publication was partially supported by grant number P01 ES012020 from the National Institute of Environmental Health Sciences (NIEHS) and the Office of Dietary Supplements (ODS), NIH. "Its contents are solely the responsibility of the authors and do not necessarily represent the official views of the NIEHS, NIH."

## The Grafting of *Cedrus libani* 'Pendula' onto *Picea abies*®

H. William Barnes

Lorax Farms LLC, Warrington, Pennsylvania 18976 U.S.A.

### INTRODUCTION

Grafting is an age-old practice and dates back to the writings of Plato and perhaps beyond. People have worked on the grafting of plants for a long time, and some techniques have certainly stood the test of time. One common thing is the occurrence of intraspecific grafts.

It is not unusual to find *Citrus sinensis* grafted onto *C. ×paradisi* or *C. reticulata*. Nor is it difficult to find any number of different rose species being grafted onto *Rosa multiflora*. This close matching of the different species can take place due to the high degree of kinship that being in the same genus provides. There is no sure guarantee of success because plant taxonomy can develop into highly distinct subgroups within a genus that inhibits or makes some graft combinations unsuitable, such as grafts between members of *Acer* that belong to the subgroup *platanoides* and those that belong to *macrantha* series. Sometimes it can be even more extreme with *Acer rubrum* cultivars often exhibiting severe graft incompatibility even when grafted onto *A. rubrum* seedlings. The same trend holds for species within the genus *Quercus* as well.

On the contrary it is not hard to find interspecific grafts that are successful, although the catalog of cross-genus grafts is not nearly as large as cross-species grafts and is for the most part limited to specific plant families such as the Rosaceae, the Rutaceae, the Solanaceae, and the Cupressaceae. Grafts of *Amelanchier* species onto *Crataegus* or *Sorbus* are not unusual and succeed for long periods of time. *Citrus sinensis* can be successfully grafted onto *Poncirus trifoliata*, and *Chamaecyparis* can be grafted to *Juniperus* or *Thuja*. Tomatoes (*Lycopersicon esculentum*) can be grafted onto potatoes (*Solanum tuberosum*). Again, the degree of kinship plays an important role in just how successful these combinations can be, and some taxonomic classifications cannot necessarily indicate this because not all members of a family will readily graft onto others, such as *Pinus strobus* not being suitably grafted onto *P. thunbergii*, although it should be noted that the reverse graft *P. thunbergii* onto *P. strobus* can be achieved (personal observation).

It is not generally thought that anything but *Picea* species can be grafted onto other *Picea* species, with *P. abies* being the universal rootstock for most *Picea* combinations. Although it should be noted that the grafting of some *Picea* such as *P. pungens* Glauca Group to *P. abies* is not always an easy accomplishment. Even with that given due consideration, cursory examination of cones, flower formation, and seeds of *Picea* and related genera such as *Abies*, *Pseudotsuga*, and *Cedrus* suggests that those combinations might work as well.

Since *P. abies* was readily at hand and *C. libani* 'Pendula' was also available, a small experiment was undertaken to see if this theory might work.

### MATERIALS AND METHODS

*Picea abies* seedlings in 10-cm pots were obtained in late summer. Plants were 30 cm high and about 3–5 mm in stem diameter. They were allowed to go into winter

normally and kept in a poly-covered house until January, when they were brought into a warm greenhouse and allowed to form new white roots.

Since this was a limited experiment, a small quantity of *C. libani* 'Pendula' scions was collected on a day above freezing and kept in a cooler at 4 °C. Scions were held for about 3 weeks prior to grafting.

A standard side graft was used and tied with rubber strips, which were in turn covered with Parafilm™ M, lab grade. (Modern Biology, Inc.). *Cedrus* scions were about 15 cm long with some degree of 2-year wood when possible. The *C. libani* 'Pendula' grafts were placed sideways in poly boxes (30 cm height × 33 cm width × 85 cm length) with a layer of perlite in the bottom to provide humidity. The boxes were sealed with the accompanying lids and placed on bottom heat pipes set at 10 °C. Grafts were left in place for about 4 weeks, after which time bright sunny conditions forced their removal due to solar heating affects.

## RESULTS

Interestingly, some 50% of the *C. libani* 'Pendula' grafts were alive and pushed new growth in spite of the heating affects of bright sunny days in late February. By September those that made it past June were still alive and looking normal.

Does this mean that *P. abies* can be an alternative rootstock for *C. libani* 'Pendula' while normally *C. deodora* is the preferred choice? At the time of this report the grafts are still alive but delayed graft incompatibility still might set in. However, the fact remains that some 6 months later there has been no decline. A natural course through winter might be indicative of future progress. Since this is encouraging it is thought that a much larger test is in order to further test this graft combination.

# A Taxonomic Revision of *Chamaecyparis nootkatensis* f. *pendula* and Implications for Rootstock Selection for Grafting®

H. William Barnes

Lorax Farms LLC, Warrington, Pennsylvania 18976 U.S.A.

## INTRODUCTION

In the last 5 years the genus and species of *Chamaecyparis nootkatensis* and its cultivars have undergone a large taxonomic revision. This revision was fully warranted and justified both from a taxonomic point of view as well as from a horticultural perspective.

The genus and species of *Chamaecyparis nootkatensis* as of 2004 (Little et al., 2004) has now been changed to *Callitropsis nootkatensis* (Little, Schwarzbach, Adams & Hsieh). Earlier revisions of the genus changed the formal name to *Xanthocyparis nootkatensis* (Farjon & Harder) (Farjon et al., 2002), but subsequent work and approval of the International Committee for Binomial Nomenclature has verified the genus to be *Callitropsis* (Wikipedia, 2005).

This is of significance to propagators, horticulturalists, and plant breeders due to confusion created by the original grouping of *Callitropsis nootkatensis* in the genus, *Chamaecyparis* and referred to for many years as *Chamaecyparis nootkatensis* (D. Don) Spach. However, horticulturally *Chamaecyparis nootkatensis* never behaved like any other members of the genus *Chamaecyparis*. There is little or no evidence of it being grafted to other *Chamaecyparis* with any degree of success, nor did it hybridize with other *Chamaecyparis* (Manor House Arboretum, 2005). From a production point of view it would root from cuttings but sparingly so, and grafting was the preferred mode of production; however, this was not entirely successful (Barnes personal observation, 2005). Two of the most frequent rootstocks for the grafting of members of the *Cupressaceae* are *Juniperus virginiana* 'Hetzi Glauca' and *Thuja nigra*. Anecdotal information suggests *Callitropsis nootkatensis*, masquerading as *Chamaecyparis nootkatensis*, often exhibited immediate graft incompatibilities that often killed as much as 50% of the original grafts, and this was followed by delayed graft incompatibilities, which claimed another percentage. The overall take was poor for the long term. Large field-grown trees with the advent of cone formation would simply up and die with no real explanation of what caused the sudden decline and death of the plant (Barnes personal observation, 2005).

The graft incompatibilities and the poor rooting performance suggests that the former *Chamaecyparis nootkatensis* was not a *Chamaecyparis* but something else as no other members of the *Chamaecyparis* group behaved like this, especially with graft incompatibility to *Juniperus*, something that just does not occur with the more common species of *Chamaecyparis*. Further examination shows that the seeds of *Callitropsis nootkatensis* do not resemble in any way the seeds of other members of the genus *Chamaecyparis* but instead have a close affinity to those of *Cupressus* (Wikipedia, 2005). When all of the factors plus DNA and phytochemical studies are taken into account it is certain that *Callitropsis nootkatensis* (Little, 2004), now reclassified, is not closely related to the *Chamaecyparis* genus.

Industry practice has shown repeatedly that the choice rootstocks for grafting *Chamaecyparis* do not apply to *Callitropsis nootkatensis*, and ideally other rootstocks should be considered.

The closest relatives to *Callitropsis nootkatensis* for rootstocks would be, in descending order, *Callitropsis nootkatensis* seedlings, *Callitropsis vietnamensis* seedlings (Gymnosperm database. 2005) (formerly *Xanthocyparis vietnamensis*) (Farjon et al., 2002), species of the genus *Cupressus*, and *XCupressocyparis leylandii*, (*Cupressus macrocarpa*  $\times$  *C. nootkatensis*), *XCupressocyparis notabilis* (*Cupressus arizonica* var. *glabra*  $\times$  *C. nootkatensis*), and *XCupressocyparis ovenzii* (*Cupressus lusitanica*  $\times$  *C. nootkatensis*). (Note: The *XCupressocyparis* hybrids have now been changed to *XCuprocyparis leylandii*, *XCuprocyparis notabilis*, and *XCuprocyparis ovenzii*.)

Of this group some can be excluded. *Cupressus* have poor root systems and topple frequently in field and landscape situations. *Callitropsis vietnamensis* is tropical and only pertinent for the deep southern portions of the U.S.A. and is not generally available. *XCupressocyparis notabilis* also is of a tropical origin and unsuitable for most of the U.S.A., *XCupressocyparis ovenzii*, while present in the U.S.A., is not common. However, Leyland cypress, *XC. leylandii* is common, fairly cold tolerant, and can be easily grown from cuttings, although it should be noted that toppling of large trees and a canker disease may limit its use in the future.

## MATERIALS AND METHODS

To look further at the grafting situation it was decided to consider *XC. leylandii* as a possible rootstock for *C. nootkatensis* f. *pendula*.

Rooted cuttings of *XC. leylandii* were obtained in 2¼-inch pots and were fully rooted.

They were cared for normally and allowed to enter winter in a cold polyhouse and were brought into a warm greenhouse in January and placed on heat pipes at 10 °C. After a period of weeks white roots were in formation and grafting could commence. Top growth was reduced by one half to around 25–30 cm.

Scionwood of *C. nootkatensis* was obtained from field-grown plants on days when it was above 0 °C and stored in polybags with moist toweling at 4 °C until use, about 2–3 weeks.

At the time of grafting the scionwood was removed, held for several hours at room temperature to warm up and then grafted. Two-year-old wood was selected about 6–8 cm long and trimmed so that the top of the scion foliage was reduced and was cut differently when compared to that of the understock. It is very hard to distinguish between grafted scions and rootstock that has been cut back so distinctive cuts have to be implemented to tell them apart. This is especially important several months later when the understock is cut off leaving the surviving scions.

A typical side graft was used and tied with grafting rubbers strips, which were in turn sealed with 4 cm  $\times$  2.5 cm strips of Parafilm M laboratory grade (Modern Biology, Inc., West Lafayette Indiana 47906). Finished grafts were placed sideways in sealable clear polyethylene boxes (30 cm H  $\times$  33 cm W  $\times$  85 cm L) with 5 cm of moist perlite placed in the bottom. Grafts were placed in such a manner to maximize quantity in the box and yet to protect the scions from mechanical damage. Boxes of grafts were placed directly on the 10 °C heat pipes. Grafts were periodically watered on as-needed basis if dry spots became a problem. After 6 weeks the boxes were

vented slowly for about a week, before the lids were fully removed and the grafts stood upright in normal greenhouse conditions.

## RESULTS

The grafting work was carried out for two separate years. Year 1 results had a grafting percentage of 78%, and Year 2 had a percentage of 52%. The discrepancy in year 2 being attributed to rootstocks that were overgrown and root bound, a problem that can occur quickly with a fast-growing plant such as *×C. leylandii*.

Initially the grafts made little or no growth the first year, but following a winter period they started growing and picked up the pace considerably. They do not grow as fast as *×C. leylandii* but more closely follow what would be natural for *C. nootkatensis*.

## LITERATURE CITED

- Barnes, H.W.** 2005. Personal observations and interviews with growers.
- Farjon, A., N.T. Hiep, D.K. Harder, P.K. Loc, and L. Averyanov.** 2002. A new genus and species in the Cupressaceae (Coniferales) from northern Vietnam, *Xanthocyparis vietnamensis*. *Novon* 12:179–189.
- Gymnosperm database.** 2005. <[www.conifers/cu/call2/nootkatensis.htm](http://www.conifers/cu/call2/nootkatensis.htm)>.
- Little D.P., A.E. Schwarzbach, R.P. Adams, and C.-F. Hsieh.** 2004. The circumscription and phylogenetic relationships of *Callitropsis* and the newly described genus *Xanthocyparis* (Cupressaceae). *Amer. J. Bot.* 91(11):1872–1881.
- Manor House Arboretum.** 2005 <[www.pennine.demon.co.uk/Arboretum/Xano.htm](http://www.pennine.demon.co.uk/Arboretum/Xano.htm)>.
- Wikipedia, the free encyclopedia.** 2005. Accessed 2005. <[http://en.wikipedia.org/wiki/Nootka\\_cypress](http://en.wikipedia.org/wiki/Nootka_cypress)>.



## Grafting of *Prunus davidiana*: Possibilities for Production®

H. William Barnes

Lorax Farms LLC, Warrington, Pennsylvania 18976 U.S.A.

*Prunus davidiana* (Carr) Franch., David's peach, is a large deciduous tree from central and Northern China. Griffiths (1994) gives it a hardiness rating of Zone 4, and it exercises considerable potential for use in the Midwest and western states as a possible flowering ornamental tree.

The Morris Arboretum of the University of Pennsylvania has a large specimen that is in decline after being in place for some 40+ years. Since the tree is destined for take down, an effort was initiated to preserve the original plant via propagation. Due to the age of the tree it seemed futile to try to propagate it via cuttings because the nearest branches to the ground were some 15 ft up. Instead it was thought that grafting should be accomplished initially and then growing on the grafts to provide suitable material for cutting propagation in the near future.

### MATERIALS AND METHODS

In early March when temperatures were above freezing scions were removed from the lowest branches via pole pruner and selected for those with the least amount of flower buds. *Prunus davidiana* has an abundance of 2.5-cm flowers, and the incidence of flowers during the grafting process can be detrimental to the take of the grafts as they consume valuable scion resources that cannot be readily replaced. Scions were stored in a refrigerator at 4 °C for 1 week before being grafted.

Since very little if anything has been written about *P. davidiana*, grafting understocks were chosen from what was on hand that might be suitable. Two different understocks were available: open-pollinated seedlings of *P. pendula* 'Pendula Rosea' (syn. *P. subhirtella pendula*) and *P. cyclamina*. Plants with established root systems and stems about 30 cm long and 4 to 5 mm diameter were selected as good rootstocks.

Scions were removed from the refrigerator and allowed to warm to room temperature, about 18 °C. Whenever possible, scions were reduced to just a single stem, and if obvious, flower buds were removed. However, it was not always possible to remove flower buds. Scions were side grafted onto the respective understocks with care being taken to positively identify rootstocks by species. Grafts were wrapped with narrow rubber budding strips, which were in turn covered with wrap of Parafilm M, laboratory grade (Modern Biology, Inc., West Lafayette, Indiana). The tops of the understocks were reduced by 10 cm, and the completed grafts were placed on their side in clear poly boxes (30 cm height × 33 cm width × 85 cm long) with 5 cm of moist perlite placed in the bottom. Grafts were stacked on their sides in such a way as to protect the scions but also to maximize the total number of plants in each box. After being placed in the boxes a lid was placed on the boxes essentially sealing the boxes and trapping both heat and humidity. Bottom heat was maintained at 10 °C, and boxes were kept out of direct sunlight.

The grafts were checked periodically for water and drying out and after 6 weeks were vented for 1 week and finally removed from the boxes to the open air in the greenhouse.

## RESULTS AND DISCUSSION

Table 1 lists the details of this experiment. It should be noted that in the art and science of grafting there are many variables, some of which are not easily known nor understood. Also experience has demonstrated that some plants such as *Pinus strobus*, *Malus*, and some species of *Prunus* are essentially easy to graft and the takes are high while others are not. Some species such as *Picea pungens* and most *Fagus* are notoriously difficult to achieve profitable results. It is not always clear as to whether these situations are understock or scion derived, or if the poor take is indicative of some specific graft incompatibility. Conditions vary from year to year and ephemeral conditions of both the scion and the understocks can change without their being readily apparent. However given that as much as possible was controlled Table (1) suggests there might be differences in the choice of understock based upon final percentage. It is understood that statistically this might not hold up since the sample size was so small, nevertheless the results do indicate that differences can be found with a bias being slanted towards *P. pendula* as the more desirable rootstock.

Casual observations show that the resultant growth from the successful grafts was noticeably different. Growth on *P. pendula* was rapid, very prolific, and upright with some growing 25–30 cm. Growth on *P. cyclamina* was stunted, slow, and in all cases was almost lateral demonstrating something approaching plagiotropism. It seems odd that an understock of an upright tree would cause a plagiotropic response in a graft of a closely related species and this cannot be readily explained.

It is predicted that over the short term those grafts on *P. pendula* will remain vigorous and vibrant whereas those on *P. cyclamina* will fail to grow and will die in a short period of time.

**Table 1.** *Prunus davidiana* grafting success.

Understock	Start date	Quantity	Evaluation date	Quantity at evaluation	Success (5)
<i>Prunus pendula</i>	05 March 05	12	05 July 05	9	75%
<i>Prunus cyclamina</i>	05 March 05	6	05 July 05	3	50%

## LITERATURE CITED

Griffiths, M. 1994. Index of garden plants. Timber Press. Portland, Oregon.

# Propagation of *Osmanthus armatus* From Hardwood Cuttings<sup>®</sup>

H. William Barnes

Lorax Farms LLC, Warrington, Pennsylvania 18976 U.S.A.

## INTRODUCTION

*Osmanthus armatus* Diels is a large holly-like evergreen shrub from 2–4 m and approximately the same spread. The oblong ovate leaves (7–14 cm) are dark green and glossy and are heavily toothed. They are quite stiff and are generally inflexible. New growth has reddish tints. Like other members of the genus, the flowering of *O. armatus* is pronounced, with a strong fragrance. Griffiths (1994) lists the presence of purple fruit, but observation of isolated plants over a number of years has failed to find any fruit. It is possible that like some other members of the Oleacea the plant could be dioecious or self-sterile. Hardiness is listed as a Zone 7, but plants in Philadelphia, Pennsylvania, have stood the test of time and are fully a Zone 6. It is not encountered frequently in the landscape, and perhaps this is because it is essentially a very large evergreen bush, although on large estates or plantings it could have a significant presence. Ideally it should be placed so that the scent of the highly fragrant flowers can be appreciated.

## MATERIALS AND METHODS

Cuttings of *O. armatus* were obtained on a day when temperatures were above freezing during the month of January and held in a cooler at 4 °C until March. The cuttings were from 10–16 cm long with four to five leaves attached. Wood was selected for being stout and quite firm. Large stem diameter was preferred with 2-year wood being preferable. Cuttings were wounded and 5000 ppm IBA in propylene glycol (Barnes, 1989). They were stuck in a 1 sand :1 ground pine bark (v/v) mix in an open tray with bottom heat at 10 °C. Air temperatures were allowed to fluctuate depending on sunny conditions. Cuttings were syringed with water as needed generally from one to two times a day.

## RESULTS AND DISCUSSION

By mid May cuttings were removed and potted with a 60% take. Cuttings were removed from the trays, potted, and placed under mist for 5 days in July. They proceeded to initiate new growth almost immediately upon being removed from the mist with temperatures in and around 28–32 °C.

It seems likely that with an increase in bottom heat an even greater rooting percentage could have been obtained, but hormone levels and the type of cutting seemed to be in balance when compared to efforts with other *Osmanthus* species.

Barnes (1989) showed that a related species, *O. americanus*, rooted very well with IBA in propylene glycol under similar circumstances. Jacobs (1990) worked with *O. fragrans* in August and got good rooting with K-IBA on cuttings that were hardened spring growth. Stephens (2000) mentions that *O. fragrans* f. *aurantiacus* rooted slowly from cuttings taken in mid to late May in South Carolina with 8000 ppm KIBA. In all cases some common requirements should be met. The wood has to be well hardened. Hormone levels should be reasonably high, and high ambient

temperatures or bottom heat is helpful. Mist may or may not be a requirement depending upon the time of year. Cuttings of *O. armatus* did not have a lot of leaf drop during the winter months, although cuttings of *O. heterophyllus* has a significant leaf drop, often denuding the cutting completely and rendering it unsuitable from that point on under similar circumstances. *Osmanthus armatus* cuttings are not fussy once rooted and if transplanted early will resume growth before fall.

### SIGNIFICANCE TO THE NURSERY INDUSTRY

*Osmanthus armatus* is an attractive shrub and has good cold hardiness possibilities. Flowering, while insignificant, is quite fragrant, and the shrub does have merits for fragrance in the garden. In many instances it could be planted in the same situations as many hollies.

### LITERATURE CITED

- Barnes, H.W. 1989. Propylene glycol quick dips: Practical applications. Comb. Proc. Intl. Plant Prop. Soc. 39:427.  
 Griffiths, M. 1994. Index of garden plants. Timber Press. Portland, OR.  
 Jacobs, R.M. 1990. New propagation techniques. Comb. Proc. Intl. Plant Prop. Soc. 40:394.  
 Stephens, T. 2000. Some exciting new woodies and perennials for zones 7, 8 and 9. Comb. Proc. Intl. Plant Prop. Soc. 50:496.

---

## ***Mespilus canescens* a Newly Discovered Species: Propagation by Grafting onto *Crataegus*®**

**H. William Barnes**

Lorax Farms LLC, Warrington, Pennsylvania 18976 U.S.A.

### INTRODUCTION

*Mespilus canescens* (Sterns medlar) was discovered in 1990 in the 22-acre Konecny Grove Natural Area in Arkansas (Center for Plant Conservation, 2005). Phipps (1991) documented *M. canescens* to be an additional new species to the heretofore-single genus and species, *M. germanica*, a European plant.

Further work by Phipps et al. (1991) demonstrated that isozyme analysis positively grouped the new plant as a *Mespilus* species. However, Dickinson et al. (2000) suggests that due to the close relationship of *M. canescens* to *Crataegus* there is some DNA evidence to suggest that it might be of hybrid origin. Further evidence of the kinship to *Crataegus* is given credence by noting that both *M. canescens* and a number of *Crataegus* have 20 stamens. Dickinson (2000) also mentions that *M. canescens* is almost indistinguishable from many *Crataegus* species, although it does lack thorns. Further evidence supporting the kinship of *Crataegus* to *Mespilus* is offered by Griffiths (1994) who lists  $\times$ *Crataemespilus gilliotii* and  $\times$ *Crataemespilus grandiflora*; two hybrids *Crataegus monogyna*  $\times$  *Mespilus germanica* and *Crataegus laevigata*  $\times$  *Mespilus germanica*, respectively. Since *M. canescens* does not seem to reproduce in the natural state researchers from the Missouri Botanic Gardens (Center for Plant Conservation, 2005) have tried and succeeded in rooting cuttings and attempted tissue culture as well. (Author's note: the fact that cuttings root

temperatures or bottom heat is helpful. Mist may or may not be a requirement depending upon the time of year. Cuttings of *O. armatus* did not have a lot of leaf drop during the winter months, although cuttings of *O. heterophyllus* has a significant leaf drop, often denuding the cutting completely and rendering it unsuitable from that point on under similar circumstances. *Osmanthus armatus* cuttings are not fussy once rooted and if transplanted early will resume growth before fall.

### SIGNIFICANCE TO THE NURSERY INDUSTRY

*Osmanthus armatus* is an attractive shrub and has good cold hardiness possibilities. Flowering, while insignificant, is quite fragrant, and the shrub does have merits for fragrance in the garden. In many instances it could be planted in the same situations as many hollies.

### LITERATURE CITED

- Barnes, H.W. 1989. Propylene glycol quick dips: Practical applications. Comb. Proc. Intl. Plant Prop. Soc. 39:427.
- Griffiths, M. 1994. Index of garden plants. Timber Press. Portland, OR.
- Jacobs, R.M. 1990. New propagation techniques. Comb. Proc. Intl. Plant Prop. Soc. 40:394.
- Stephens, T. 2000. Some exciting new woodies and perennials for zones 7, 8 and 9. Comb. Proc. Intl. Plant Prop. Soc. 50:496.

---

## ***Mespilus canescens* a Newly Discovered Species: Propagation by Grafting onto *Crataegus*®**

**H. William Barnes**

Lorax Farms LLC, Warrington, Pennsylvania 18976 U.S.A.

### INTRODUCTION

*Mespilus canescens* (Sterns medlar) was discovered in 1990 in the 22-acre Konecny Grove Natural Area in Arkansas (Center for Plant Conservation, 2005). Phipps (1991) documented *M. canescens* to be an additional new species to the heretofore-single genus and species, *M. germanica*, a European plant.

Further work by Phipps et al. (1991) demonstrated that isozyme analysis positively grouped the new plant as a *Mespilus* species. However, Dickinson et al. (2000) suggests that due to the close relationship of *M. canescens* to *Crataegus* there is some DNA evidence to suggest that it might be of hybrid origin. Further evidence of the kinship to *Crataegus* is given credence by noting that both *M. canescens* and a number of *Crataegus* have 20 stamens. Dickinson (2000) also mentions that *M. canescens* is almost indistinguishable from many *Crataegus* species, although it does lack thorns. Further evidence supporting the kinship of *Crataegus* to *Mespilus* is offered by Griffiths (1994) who lists  $\times$ *Crataemespilus gilliotii* and  $\times$ *Crataemespilus grandiflora*; two hybrids *Crataegus monogyna*  $\times$  *Mespilus germanica* and *Crataegus laevigata*  $\times$  *Mespilus germanica*, respectively. Since *M. canescens* does not seem to reproduce in the natural state researchers from the Missouri Botanic Gardens (Center for Plant Conservation, 2005) have tried and succeeded in rooting cuttings and attempted tissue culture as well. (Author's note: the fact that cuttings root

tends to push this plant away from being a *Crataegus* since few if any *Crataegus* will root from cuttings.) Further propagation is needed to ensure the survival of the species because it is specifically limited in the wild to 25 individuals (Center for Plant Conservation, 2005).

Tubeasing (1988) mentioned the grafting of *M. germanica* onto *Pyrus ussuriensis* as something that works but is limited due to delayed graft incompatibility. Del Tredici (1995) mentioned in a review article a passing reference to *M. germanica* being propagated from root cuttings, but due to the unique situation of *M. canescens* this approach did not seem practical or available. Grafting was chosen as a possible propagation technique based on the time of year that rootstocks of *Crataegus* are generally quite available and the kinship of *Mespilus* to *Crataegus* has been well established.

## MATERIALS AND METHODS.

One sizeable plant of *M. canescens* is at the Mountain Crops Research Station of the North Carolina State University in Fletcher, North Carolina. Dr. Tom Ranney graciously supplied a small amount of scion wood for propagation experimentation at Lorax Farms. Scions were received in late February and in anticipation of their arrival several seedling *C. maximowiczii* were put into a warm greenhouse (10 °C) and forced into active root growth. A typical side graft was used and tied with a rubber budding strip then sealed with Parafilm™ M (Modern Biology, Inc.). Only two grafts were made, and they were done on the same rootstock species. The completed grafts were tented with large, 4-L, Zip Loc bags. Bags were sealed so that moisture was retained around the grafts provided by a damp paper towel at the base of the bag and the grafts were placed in such a way as to avoid direct sunlight. Approximately 6 weeks after grafting and temperatures and light levels were on a steady increase, buds of the *M. canescens* started to break; at this juncture the sealed bag was slowly vented to allow in fresh air. Slowly over a period of 1 week the bag was vented further and further so that the soft new growth could acclimate to the normal greenhouse air conditions and humidity. Bottom heat by the end of the 6-week period had gradually been raised to 20 °C.

The *Mespilus* grafts were potted on and allowed to grow for another 2 months when the rubber grafting strips and Parafilm™ were removed and replaced with blue painters' masking tape. The tape was put on in such a way as to prevent accidental damage to the new graft union. There was a 100% success. After 2 years the grafted plants are still growing with no suckering from the *Crataegus* rootstock.

From this limited work it is suggested that *C. maximowiczii* works well as a rootstock for *M. canescens* and that bulking up of the few available plants could well be accomplished by this technique.

**Acknowledgments.** A thanks is extended to Dr. Tom Ranney for the scionwood of *Mespilus canescens*.

## LITERATURE CITED

- Center for Plant Conservation. 2005. <[centerforplantconservation.org/ASP/CPC](http://centerforplantconservation.org/ASP/CPC)>.
- Del Tredici, P. 1995. The propagation of hardy woody plants from root cuttings: A review. Comb. Proc. Intl Plant Prop. Soc. 45:431.
- Dickinson, T. 2000. <[www.botany.utoronto.ca/courses/Bot307/D\\_Families/307D2\\_Crataegus.html](http://www.botany.utoronto.ca/courses/Bot307/D_Families/307D2_Crataegus.html)>.

- Dickinson, T.A., R.C. Evans, and C.S. Campbell. 2000. Phylogenetic relationships between *Crataegus* and *Mespilus* (Rosaceae subf. Maloideae) based upon rDNA sequence variation. <[www.ou.edu/cas/botany-micro/botany2000/section13/abstracts/44.shtml](http://www.ou.edu/cas/botany-micro/botany2000/section13/abstracts/44.shtml)>.
- Griffiths, M. 1994. Index of garden plants. Timber Press. Portland, Oregon.
- Phipps, J.B. 1990. *Mespilus canescens*. A new rosaceous endemic from Arkansas. Syst. Bot. 15:26-32.
- Phipps, J.B. 1991. Isozyme evidence for naturalness of *Mespilus* L. (Rosaceae, subf. Maloideae) Syst. Bot. 16:546-552.
- Tubeising, C. 1988. Strange grafts I have known. Comb. Proc. Intl. Plant Prop. Soc. 38:184.

---

## Somatic Embryo Development in Willow Oak®

S. Wells, S.T. Kester, and R.L. Geneve

Department of Horticulture, University of Kentucky, Lexington, Kentucky 40546 U.S.A.

### INTRODUCTION

Willow oak (*Quercus phellos*) is an important landscape plant and forestry tree generally propagated by seed for commercial production. Recent propagation of willow oak has been through cuttings taken from juvenile stock plants; however this does not allow for selection of mature characteristics such as autumn color, tree shape, winter hardiness, or ease of production. Somatic embryogenesis would allow for the mature mother plant to be rejuvenated into a juvenile form for cutting propagation while still having the clonal characteristics desired (Geneve et al., 2003).

Somatic embryogenesis has been reported in a number of oak species, with the majority of the work being performed in English (*Q. robur*) and cork oak (*Q. suber*). In these species, the frequency of somatic embryo induction is between 80% and 100% from immature zygotic embryo explants but less than 15% using seedling leaf tissue (Wilhelm, 2000). However, regardless of the initial source, somatic embryo maturation, conversion, and germination have been difficult. Often the somatic embryo forms shoots or roots only, and complete recovery of plants is at a low frequency (Wilhelm, 2000).

Typical treatments used to enhance normal somatic embryo formation and encourage conversion include abscisic acid (ABA) and altering the osmotic potential of the medium using sucrose, mannitol, and sorbitol. Treatments used to stimulate germination in oaks are cytokinins and gibberellic acid (Wilhelm, 2000). The objective of this research was to investigate the effects of ABA, cytokinin, gibberellic acid, and sucrose concentration on development of somatic embryos derived from immature cotyledons of willow oak.

### MATERIALS AND METHODS

Acorns were collected in August and surface-sterilized in 10% bleach for 15 min, followed by a dip in 70% ethanol and rinsed three times with sterile water. Cotyledon halves from the zygotic embryo were placed on MS (Murashige and Skoog, 1962) basal media in Petri plates containing 1  $\mu$ M benzyladenine (BA) and 0, 1, 5, or 10  $\mu$ M naphthaleneacetic acid (NAA). These plates were then placed under cool white fluorescent lights (16-h lighted photoperiod, PAR 60  $\mu$ mol $\cdot$ sec $^{-1}$  $\cdot$ m $^{-2}$ ) at 21 °C. Explants were transferred to MS medium containing no growth regulators every 3 weeks until somatic embryos formed.



- Dickinson, T.A., R.C. Evans, and C.S. Campbell. 2000. Phylogenetic relationships between *Crataegus* and *Mespilus* (Rosaceae subf. Maloideae) based upon rDNA sequence variation. <[www.ou.edu/cas/botany-micro/botany2000/section13/abstracts/44.shtml](http://www.ou.edu/cas/botany-micro/botany2000/section13/abstracts/44.shtml)>.
- Griffiths, M. 1994. Index of garden plants. Timber Press. Portland, Oregon.
- Phipps, J.B. 1990. *Mespilus canescens*. A new rosaceous endemic from Arkansas. Syst. Bot. 15:26-32.
- Phipps, J.B. 1991. Isozyme evidence for naturalness of *Mespilus* L. (Rosaceae, subf. Maloideae) Syst. Bot. 16:546-552.
- Tubeising, C. 1988. Strange grafts I have known. Comb. Proc. Intl. Plant Prop. Soc. 38:184.

---

## Somatic Embryo Development in Willow Oak®

S. Wells, S.T. Kester, and R.L. Geneve

Department of Horticulture, University of Kentucky, Lexington, Kentucky 40546 U.S.A.

### INTRODUCTION

Willow oak (*Quercus phellos*) is an important landscape plant and forestry tree generally propagated by seed for commercial production. Recent propagation of willow oak has been through cuttings taken from juvenile stock plants; however this does not allow for selection of mature characteristics such as autumn color, tree shape, winter hardiness, or ease of production. Somatic embryogenesis would allow for the mature mother plant to be rejuvenated into a juvenile form for cutting propagation while still having the clonal characteristics desired (Geneve et al., 2003).

Somatic embryogenesis has been reported in a number of oak species, with the majority of the work being performed in English (*Q. robur*) and cork oak (*Q. suber*). In these species, the frequency of somatic embryo induction is between 80% and 100% from immature zygotic embryo explants but less than 15% using seedling leaf tissue (Wilhelm, 2000). However, regardless of the initial source, somatic embryo maturation, conversion, and germination have been difficult. Often the somatic embryo forms shoots or roots only, and complete recovery of plants is at a low frequency (Wilhelm, 2000).

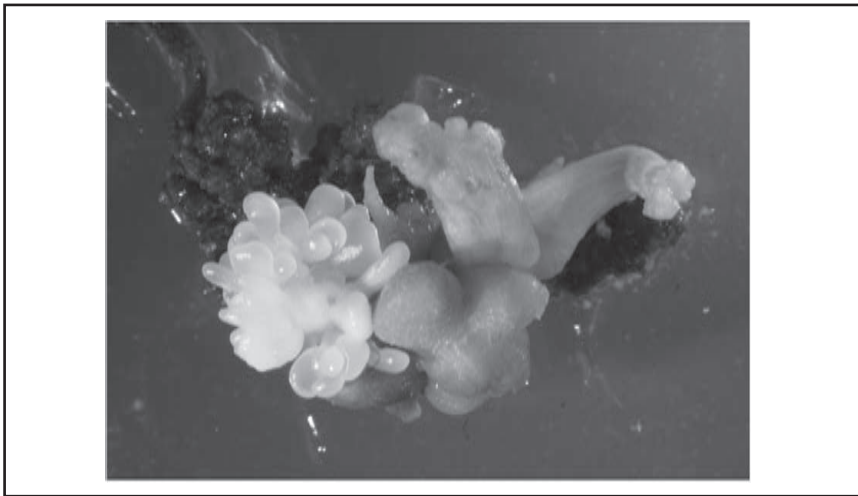
Typical treatments used to enhance normal somatic embryo formation and encourage conversion include abscisic acid (ABA) and altering the osmotic potential of the medium using sucrose, mannitol, and sorbitol. Treatments used to stimulate germination in oaks are cytokinins and gibberellic acid (Wilhelm, 2000). The objective of this research was to investigate the effects of ABA, cytokinin, gibberellic acid, and sucrose concentration on development of somatic embryos derived from immature cotyledons of willow oak.

### MATERIALS AND METHODS

Acorns were collected in August and surface-sterilized in 10% bleach for 15 min, followed by a dip in 70% ethanol and rinsed three times with sterile water. Cotyledon halves from the zygotic embryo were placed on MS (Murashige and Skoog, 1962) basal media in Petri plates containing 1  $\mu$ M benzyladenine (BA) and 0, 1, 5, or 10  $\mu$ M naphthaleneacetic acid (NAA). These plates were then placed under cool white fluorescent lights (16-h lighted photoperiod, PAR 60  $\mu$ mol $\cdot$ sec $^{-1}$  $\cdot$ m $^{-2}$ ) at 21 °C. Explants were transferred to MS medium containing no growth regulators every 3 weeks until somatic embryos formed.

**Table 1.** Percentage of somatic embryos forming a root or shoot after 2 months on MS media containing combinations of sucrose with abscisic acid or gibberellic acid.

Growth regulator	Concentration ( $\mu\text{M}$ )	Sucrose concentration (%)	
		3	6
ABA	0	15%	6%
	1	4%	18%
	5	7%	0%
GA <sub>3</sub>	10	6%	16%
	50	20%	24%



**Figure 1.** Secondary somatic embryo formation in oak after 3 months.

Somatic embryos that reached the cotyledon stage were moved to media containing ABA (0, 1, or 5  $\mu\text{M}$ ), GA<sub>3</sub> (0, 10, or 50  $\mu\text{M}$ ), or BA (0, 1, or 10  $\mu\text{M}$ ) in combination with 30 or 60  $\text{g}\cdot\text{L}^{-1}$  of sucrose. Shoot and root development were evaluated after 2 months.

## RESULTS

Somatic embryos formed at all concentrations of BA and NAA evaluated with the greatest percentage being produced at 5  $\mu\text{M}$  NAA (45%). Those at 10  $\mu\text{M}$  NAA produced somatic embryos at 11% and there was no difference between 1  $\mu\text{M}$  NAA and the control (4%).

The use of ABA or GA<sub>3</sub> only slightly increased the number of somatic embryos producing a root or a shoot (Table 1). On average there was no difference between the two concentrations of sucrose. However, the highest frequency was seen using 50  $\mu\text{M}$  GA<sub>3</sub> and 6% sucrose. Including BA in the media had no effect on shoot or root production (data not shown).

Somatic embryos producing either a root or shoot were more frequent than the development of a seedling producing both. Seedlings having both a radicle and a shoot were transferred into a perlite and peat potting mix under high humidity, but none of the seedlings developed into plantlets.

## DISCUSSION

NAA was effective at inducing somatic embryos in willow oak. NAA is often more effective than 2,4-D at inducing somatic embryogenesis in various oak species (Wilhelm, 2000). An auxin source was important in inducing primary somatic embryogenesis in willow oak, but secondary somatic embryos formed readily and repeatedly on basal medium without growth regulators (Fig. 1).

ABA is often used during somatic embryogenesis to promote more normal embryo development, but ABA usually inhibits embryo germination. Therefore, it was unexpected that ABA would promote shoot and root growth (Table 1). In cork oak, ABA reduced the development of new secondary embryos (Bueno et al., 1992). It is possible that by suppressing secondary somatic embryo formation, ABA allowed the continued development of the primary embryo that allowed it to germinate.

Gibberellic acid can be used to promote germination in slowly developing somatic embryos. Previous work with other oak species showed that GA<sub>3</sub> had a minimal effect at promoting somatic embryo germination (Kim et al., 1994; Ishii et al., 1999; Sanchez et al., 2003). More often, BA has been shown to stimulate shoot and root growth in oak (Wilhelm, 2000). However, in willow oak BA was ineffective at promoting germination, while GA<sub>3</sub> was as effective as ABA (Table 1).

Doubling the sucrose concentration did not consistently impact somatic embryo development or germination, but there was a trend towards a higher frequency of embryos with roots or shoots when grown at 6% sucrose (Table 1). Sucrose plays the dual role of providing a carbohydrate source for growth and acting as an osmoticum. It is possible that the sucrose concentration used in this work was not high enough to impact embryo development. Using cork oak, Garcia-Martin et al. (2001) found that 150 g·L<sup>-1</sup> of sucrose allowed 75% of the somatic embryos to convert to seedlings. This conversion rate is comparable to the improvement in conversion of English oak to 83% found by slowly drying somatic embryos for 3 weeks prior to germination (Wilhelm, 2000).

To date, no plantlets have been recovered from willow oak via somatic embryos. Future research will focus on adjusting the water potential of the somatic embryo by drying or exposure to high osmotic concentrations to promote more normal seedling development.

## LITERATURE CITED

- Bueno, M.A., R. Astorga, and J.A. Manzanera. 1992. Plant regeneration through somatic embryogenesis in *Quercus suber*. *Physiol. Plant.* 85:30–34.
- Garcia-Martin, G., M.E. Gonzalez-Benito, and J.A. Manzanera. 2001. *Quercus suber* L. somatic embryo germination and plant conversion: Pretreatments and germination conditions. *In Vitro Cell Dev. Biol. - Plant* 37:190–198.
- Geneve, R.L., S.T. Kester, C. Edwards, and S. Wells. 2003. Somatic embryogenesis and callus induction in willow oak. *Comb. Proc. Intl. Plant Prop. Soc.* 53:570–572.
- Ishii, K., R. Thakur, and S.M. Jain. 1999. Somatic embryogenesis and evaluation of variability in somatic seedlings of *Quercus serrata* by RAPD markers, p 403–414. In: S.M. Jain, P.K. Gupta, and R.J. Newton, eds. *Somatic embryogenesis in woody plants*, vol. 4. Kluwer Academic Publishers, Dordrecht, The Netherlands.
- Kim, Y.W., B.C. Lee, S.K. Lee, and S.S. Jang. 1994. Somatic embryogenesis and plant regeneration in *Quercus acutissima*. *Plant Cell Rpts* 13:315–318.
- Murashige, T., and F.A. Skoog. 1962. A revised medium for rapid growth and bioassays with tobacco tissue cultures. *Physiol. Plant.* 15:473–497.
- Sanchez, M.C., M.T. Martinez, S. Valladares, E. Ferro, and A.M. Vieitez. 2003. Maturation and germination of oak somatic embryos originated from leaf and stem explants: RAPD markers for genetic analysis of regenerants. *J. Plant Physiol.* 160:699–707.
- Wilhelm, E. 2000. Somatic embryogenesis in oak (*Quercus* sp.). *In vitro Cell. Dev. Biol. - Plant* 36:349–357.

## Breeding Rebloom Diploid Daylilies in Colors Other Than Yellow and Gold<sup>®</sup>

### Darrel Apps

Woodside Nursery, 327 Beebe Run Rd., Bridgeton, New Jersey 08302 U.S.A.

There are different scenarios to use in describing rebloom daylilies:

- 1) One-time repeaters—those that send up two flower stalks (scapes) in succession (usually 2–3 weeks apart) from one ramet usually after winter or a cold period.
- 2) Daylilies that send up one scape per mature ramet with rebloom coming later in the season from newly maturing ramets (mostly in evergreen daylilies not requiring a cold period).
- 3) Daylilies that produce as many as 3 or 4 flower scapes in succession from one ramet (most of these plants are dormant and require a cold period—'Stella de Oro', 'Happy Returns', 'Early And Often', and 'Rosy Returns' are examples). Sometimes this third type of rebloom is described as continuous bloom.

Rebloom amount and frequency in all of these types can be affected by the amount of sunlight, moisture content of the growing medium, levels of fertilization, and maturity of the clumps (frequent dividing enhances rebloom).

In the 1970s most of the existing cultivars that rebloomed were in yellow- and gold-colored flowers such as 'Bitsy' and 'Yellow Lollipop'. There were a few exceptions with one-time rebloomers such as 'Baby Darling' (purple), 'Sue Rothbauer' (pink), and 'Chipper Cherry' (red). In 1975 breeder Walter Jablonski introduced 'Stella de Oro', which continues to be one of the most reblooming daylilies registered by the American Hemerocallis Society.

The author initiated a rebloom-breeding program in the early 1970s to try to seek continuous-blooming daylilies in colors other than yellow and gold. My first "one-time rebloomer" produced (in a color other than yellow and gold) was 'Pardon Me'. Its maternal parent, 'Little Grapette', didn't rebloom in northern zones but had a genetic background of rebloom parents. It was crossed with a seedling from 'Golden Chimes' (some rebloom) and 'Perennial Pleasure' (also some rebloom in its background). Only one seedling out of about 50 plants rebloomed. It was named and introduced as 'Pardon Me'. The cross was repeated and yielded about 75 seedlings, and again, only one rebloomed. It was named and introduced as 'Punk'. It should be pointed out that in the 1970s hundreds of other crosses were made toward this objective of rebloom in colors other than yellow and orange, and in the end no rebloomers were produced.

'Stella de Oro' was introduced into the breeding program in 1976. Over a period of several years about 8000 seedlings were grown from many different cultivar crosses with 'Stella de Oro'. One seedling from a cross with 'Susie Wong' was selected and named 'Happy Returns' in 1984. 'Happy Returns' became an important tool for breeding colors other than yellow and orange because of its light yellow color without the pervasive deep gold carotene base color. At this time enough test crosses had been made to persuade the author that certain forms of rebloom appeared to be recessive genes.

Over the next few years several crosses were made to explore rebloom as recessive gene(s) occurring on more than one or more chromosomes. A break in color came from a complex cross. 'Pardon Me' was crossed with 'Happy Returns' and produced a non-reblooming red. That red was crossed with another seedling out of 'Sugar Cookie' by 'Happy Returns', which again produced a non-reblooming brighter red color. This complex seedling was then crossed with another complex reblooming seedling out of two rebloomers 'Brocaded Gown' × 'Happy Returns' (later named 'Fragrant Treasure'). In the final cross a high percentage of rebloom daylilies occurred in various pink shades. The most reblooming plant was selected and named 'Rosy Returns'.

'Rosy Returns' and other rebloom selections have now been crossed extensively. By combining all three types of rebloom daylilies with near-continuous-blooming plants (especially those that were not yellow or gold), it has been possible to produce many rebloom daylily seedlings in most of the common colors. Efforts are now being made by using colchicine to convert many of these selections to tetraploids and to breed tetraploid rebloomers.

## What You Need to Know About Viruses®

### Michael A. Yoshimura

Biological Sciences Department, California Polytechnic State University, San Luis Obispo, California 93407-0401

Viruses are acellular infectious agents made up of a nucleic acid core and surrounded by a protein coat. Viruses are inert or inactive when not inside a host cell.

### HOW LARGE ARE VIRUSES?

Viruses are very small and cannot be seen even with the aid of a light microscope. We measure viruses in units of nanometers, a billionth of a meter.

### WHAT DO VIRUSES LOOK LIKE?

Plant viruses are in general very simple. Most are either polyhedrons, spherical in outline but having flat sides like a geodesic dome, or rods, either short and rigid or long and flexuous.

### WHAT ARE VIRUSES MADE UP OF?

Plant viruses have nucleic acid, DNA or RNA, in their core and are surrounded by a protein coat. Viruses are not made of cells. Most plant viruses are RNA viruses. If we take a look at a rod-shaped virus such as tobacco mosaic virus, the RNA is arranged in a coil. The proteins are arranged on the outside of the virus providing a protective covering. So, the virus looks somewhat like a corn on the cob.

### HOW DO VIRUSES MULTIPLY OR REPRODUCE?

Viruses don't get food like most organisms by using enzymes to digest food. Instead, viruses take over the mechanisms of the host to produce more viruses.

Say that a memory stick is a virus and a computer is a plant cell. I attach the stick to the computer. Plant viruses will enter into the cell. The information from the memory stick moves into the computer and may affect the operations of some of the programs you have put into your computer. These computer viruses can be innocuous and not cause much of a problem, maybe those that simply report back to a company the purchases you have made with the computer. Or the virus could cause a serious problem, send out more viruses to all the addresses in your email address book, and not allow your computer to work.

A virus such as tobacco mosaic virus, after entering a host plant cell, takes over the protein synthesis system in the host and gets the host to produce more viruses. Three types of proteins are produced: (1) enzymes that produce viral RNA, (2) the coat proteins, and (3) enzymes that help viruses move to neighboring cells and eventually throughout the plant. So, new viruses are formed. Just like the computer virus, the plant virus takes over a program in the host cell, that being protein synthesis.

As new viruses are produced, the amino acids and nucleotides, the building blocks for proteins and nucleic acids in the host cell, are used to produce viruses instead of what the host needs. The general symptom produced by viruses is thus a reduction in growth or stunting. Other symptoms, such as color changes, malformations, and sometimes necroses can also be produced. So, viruses use the mechanisms of the

host, mainly protein synthesis, to produce more viruses. This causes the production of symptoms.

### **HOW DO VIRUSES MOVE THROUGH A PLANT?**

In general, viruses are able to infect the entire plant. Viruses are small enough and produce the appropriate enzymes that enable them to move between cells through passageways called plasmodesmata. These passageways also provide paths for viruses to move into the phloem and then throughout the plant. Those of you familiar with meristem culturing realize that the viruses do not become established in the rapidly dividing apical meristems. Phloem sieve tubes and plasmodesmata do not extend into those cells. But that is a very small portion of the plant. So, it is easiest to assume that all tissues within an infected plant contain the virus. Also, some viruses are able to move from the infected plant tissues into the developing seed.

Viruses do not usually kill its host, being obligate parasites that require living hosts to produce new viruses. So, within that living infected plant, a virus is forever.

### **WHAT ABOUT CONTROLS?**

When propagating vegetative materials, obviously if the stock plant is infected, the vegetative propagules will also be infected. These include cuttings, grafting materials, corms, bulbs, tubers, and rhizomes. As mentioned earlier, some viruses will also move into the developing seed. From a disease control perspective, it is very important to start with healthy plants. Since symptoms may not appear on seeds, corms, tubers, rhizomes or may not be obviously indicative of a virus disease, simply looking at the planting materials may not be enough to ensure you are starting with a clean plant. Production of pathogen-free plant stock is very involved and may require organized efforts to test plants or plant parts for viruses. Some examples of plants where such systems have been established by state agencies or commodity groups are potato, citrus, grape, strawberry, carnation, and chrysanthemums, among others.

### **VECTORS**

Specific vectors such as insects, mites, fungi, and nematodes transmit some viruses. A virus has a specific vector and is not transmitted by several different vectors. Mites do not transmit an aphid-transmitted virus, for example. Again, from a disease control perspective, not having the vector would be nice. In a field situation, another possible consideration is not being close to sources of the vector.

### **MECHANICAL TRANSMISSION**

Another way viruses can be transmitted is through mechanical means by having contaminated sap transferred from plant to plant. Usually we assume this happens when pruning or harvesting flowers, for example. Sap containing the virus is picked up on pruning shears when a branch or leaf or flower stalk is cut from a diseased plant. Then on the next cut of a healthy plant, the contaminated sap is placed onto a fresh wound and the virus gets into healthy tissues. Sanitary practices, disinfecting the pruning tools between cuts can reduce this mechanical transmission. Strong detergents and chemical disinfectants will break apart the protective protein coats of the viruses. The nucleic acids in the core can then be degraded and the virus killed.



## EXAMPLES

We had an interesting disease occurrence recently at the Ornamental Horticulture greenhouses at Cal Poly. As a plant pathologist I always enjoy seeing disease outbreaks. This involved the Impatiens Necrotic Spot Virus. Being in a teaching institution where we have a rapid turnover of student workers, we never know ahead of time the quality of care the plants and facilities will have. Over a 2- or 3-year span, students received, for their enterprise projects, seedlings infected with the virus. Since this is supposed to be an attempt at making a profit, students are hesitant to get rid of any plants that may survive to be a plant for purchase. Added to the introduction of the virus into the greenhouses, the insect vector, thrips, had become nicely established. Several established plants in the greenhouses were found with symptoms of the virus. Then a group of energetic students decided to clean up the greenhouses of any suspect plants, and serious control of the thrips population was implemented. So the source of the virus, infected plants, was removed and the vector population was reduced. My participation was helping to identify the virus using ELISA kits.

I participated in another interesting project. Do you remember when Pace Picante Sauce was first on the market and the slogan was, "A fresh jalapeno in every jar?" That requires a year-round supply of jalapeno peppers. After Campbell Soup bought Pace, my colleague got me involved in surveying pepper fields for viruses. We know that in the field, trying to control virus diseases by directly controlling insect vectors does not work well. Usually, the vector transmits the virus before the insecticide kills the bug. Our survey was aimed at establishing what fields had a lot of virus. With a large company such as Campbell Soup, it is possible to select fields to grow the crop where and when viruses are not present. One interesting outcome of the survey was that a major source of viruses for cultivated crops was ornamental plants growing in peoples' yards.

## CONCLUSIONS

In conclusion, viruses are simply constructed infectious agents made up of a nucleic acid core and protein coat. They use the mechanisms of the host to produce more viruses. Plant viruses are usually distributed throughout the plant and will reduce the productivity and quality of the plant. As plant propagators, it is important that seeds, cuttings, or transplants are clean; sources of viruses are not located nearby; and large populations of vectors are not present. If virus-infected plants are found, the diseased plants should be destroyed, and hopefully resistant types are available for cultivation.

## **New Propagation Facilities at Monrovia Nursery, Visalia, California®**

**Jeremy Bahne**

Monrovia Growers, P.O. Box 489, Woodlake, California 93286-0489

### **INTRODUCTION**

To meet propagation needs for Monrovia's current expansion, work is under way to construct additional propagation facilities at the Visalia, California location. The projects include a 4-acre glass greenhouse that is nearing completion and a 4-acre retractable shade house that was recently completed. The new facilities will provide Monrovia with increased flexibility and operational efficiency.

### **THE FOUR-ACRE GLASS GREENHOUSE**

This greenhouse is a Venlo-style house, which means that it has a truss system to support multiple ridgelines between posts. In one house there are a total of three ridgelines that measure 13.13 ft each between post lines. The house is made up of 20 gutter-connected houses that are each 39.39 by 212 ft. This house has a tempered glass roof and will be used for rooting cuttings and to house grafted trees. Glass was chosen to maximize light transmission during the cooler months. The house stands 16 ft to the gutter and has a venting ratio of 25%. For greater environmental control, the roof vents are divided into two zones and have directional control (east- and west-facing vents). For greater access to plant material and to increase natural ventilation, the north and south walls have roll-up curtains from 3 ft under the gutter to the ground. One of the venting zones houses 2 acres of concrete bottom heat, while the other zone has a rolling bench system with pipe heating. The 2 acres of concrete bottom heat are further broken down into 20 separate heating zones that measure 100 by 39.39 ft each. Within each heating zone there are two zones of mist. This provides 40 misting zones, which enables the care of crops at multiple stages of readiness. To improve drainage, the concrete was laser graded to a compound grade.

In the 2 acres of benches with pipe heat, each of the 10 houses has one stationary bench with six rolling benches and one moving aisle. The use of rolling benches makes it possible to bring the detailed work of grafting up to a comfortable level for employees and increase space usage by 16%. This area will initially be watered by hand, but provisions have been made to automate irrigation in this area at a later date. To prevent disease and aid with water recycling, a weed barrier was installed in the aisles and black plastic was placed under the benches. To help with cooling, a high-pressure fogging system will be employed and a thermal curtain may be installed to further increase heating and cooling efficiency.

### **THE FOUR-ACRE RETRACTABLE SHADE HOUSE**

The retractable shade house has the same framework as the glass greenhouse, so it can easily be upgraded if more greenhouse space is required. There are four independently operated roof zones within this structure, each encompassing 1 acre. Two of those roof zones cover the 2 acres of concrete bottom heat with the same 40-zone mist system layout as the glasshouse. This area will be used for rooting evergreen

cuttings in the winter and sun-sensitive crops in the spring and summer. The other 2 acres of this structure are unheated and will be used to maintain rooted crops until they are ready to be shifted into larger containers. The shade material used in this structure is similar to a thermal curtain, so it will provide some protection from freezing temperatures in the winter.

### GENERAL INFORMATION

The cutting production house is centrally located for improved access and material handling. It measures 78.78 by 100 ft and has the same design as the greenhouse. The primary difference between this house and the greenhouse is that the roof and side-walls are covered with white acrylic to reduce heat build up. This structure will house two cutting lines, and a plug transplanter, flat filler, potting machine and soil mixer.

The 6-acre heating system is powered by two water heaters each with a capacity of 14 million Btu/h. The water heaters will operate in tandem to reduce equipment wear. The pipe heating for the rolling benches operates directly off the water heaters, while the concrete bottom heat is separated from the water heaters with a heat exchanger. With the addition of a flue gas condenser, this system will operate at a level of 96.7% efficiency (104% by American standards).

Water for the propagation area comes from 20 different wells on the nursery and is seasonally combined with water from a local river. The water is stored in two different tanks in the propagation area. Water entering the first tank is injected with chlorine for pathogen control. This fresh water tank is used to feed the mist system and for irrigating seedling flats. The water in the second tank is injected with chlorine and fertilizer. The fortified water is used to irrigate freshly rooted crops and to maintain finished crops. All of the water used in propagation is recycled for use in regular production areas. By using only a fresh water source in propagation, the spread of disease and weed seeds is prevented.

There are two systems used to control automation in propagation. In the glass-house and retractable shade, Argus Control Systems are employed to control mist, irrigation, venting, shading, heating, cooling, and fertilizer injection. In the other 18 acres of propagation, a proprietary vapor-pressure-deficit system is used to control irrigation and fertilizer injection. In the two acres of open section mist and 1 acre of 50% shade mist, Phytotronic six-zone misting controllers with Intermatic 24-h time switches are utilized.

### THINGS YOU SHOULD KEEP IN MIND DURING EXPANSION

- Plan, Plan, Plan.
- Study up by reading, talking to builders, and visiting other nurseries.
- Check with local officials for zoning and permit requirements.
- Work with your growers to meet their needs. The growing environment that you will create should be your first concern. Bells and whistles can come later.
- Build to fit your systems.
- Build for flexibility. Does your system allow for the use of new chemicals, new equipment, new containers, and new product lines?
- Build back-ups into the system that allow you to maintain the growing environment if a system failure occurs, i.e., gas, electric, water, and heating.

- Know who is responsible for labor, materials, and equipment. Foundations, wiring, downspouts, and groundwork are generally not included.
- Expect projects to take longer and cost more than you plan.

#### LITERATURE CITED

- Bartok, J.W. Jr.** 1997. Ten ideas to improve your next greenhouse. *GMPro*. June:44.
- Davis, T.** 1997. Avoid expansion and startup headaches. *Greenhouse Mgt. Professional* June:26-28.
- Roberts, W.J.** 1999. Avoid the obstacles of facilities expansion. *Greenhouse Mgt. Professional* June:28-31.

---

### General Session I: Question and Answer Session<sup>®</sup>

**Kristin Yanker-Hansen:** Can plants develop resistance to viruses and does the health of the soil help?

**Michael Yoshimura:** The common rose mosaic virus is not transmitted by any known vector. Plants that contain the viruses started out with the virus. It would not be carried from that diseased plant to other plants. Viruses react like other microorganisms, and their infectability depends on the host and the environment, which determine whether we see symptoms or not. Usually viruses are inhibited, they aren't as active, when temperatures are high so we tend to see rose mosaic virus most often in the springtime when the new leaves are out and then as it gets warmer we tend not to see them as much. Plants do have resistance to these microorganisms. The reaction between the virus and the host will determine the severity of the symptoms. Rose mosaic virus is not a very severe virus. It doesn't apparently harm the plant, and the plant will survive year after year with the virus in it. It doesn't affect the quality or appearance of the flower. Overall, infected plants seem to grow very well. Maintaining healthy plants probably does help the plant, but it's more a case of genetic resistance.

**Tom Branca:** If we want to propagate virus-infected plants conventionally, is there a distance behind the apical meristem or lateral meristem where the virus is absent so cuttings we take will be virus-free?

**Michael Yoshimura:** Viruses spread within the plant via plasmodesmata, and those haven't yet formed in the apical meristem. Viruses also move through the phloem, and it hasn't formed yet in the apical meristem either. Depending on the plant species then the virus will get very close to the apical meristem. Usually when you do meristem culture you grow the plant at an elevated temperature to slow down the growth of the virus and hope it gets farther away from the apical meristem and then excise the apical meristem so you can obtain a plant without the virus. Some chemicals (Ribavirin) have been used to slow down the virus.

**Tom Branca:** What actually makes a species? How do we determine taxonomically what the difference between genus and species is? You said that we can have two plants that look alike phenotypically, but yet genotypically they are somewhat different. From a molecular viewpoint how do you determine what a species is?

- Know who is responsible for labor, materials, and equipment. Foundations, wiring, downspouts, and groundwork are generally not included.
- Expect projects to take longer and cost more than you plan.

### LITERATURE CITED

- Bartok, J.W. Jr.** 1997. Ten ideas to improve your next greenhouse. *GMPro*. June:44.
- Davis, T.** 1997. Avoid expansion and startup headaches. *Greenhouse Mgt. Professional* June:26-28.
- Roberts, W.J.** 1999. Avoid the obstacles of facilities expansion. *Greenhouse Mgt. Professional* June:28-31.

---

## General Session I: Question and Answer Session<sup>®</sup>

**Kristin Yanker-Hansen:** Can plants develop resistance to viruses and does the health of the soil help?

**Michael Yoshimura:** The common rose mosaic virus is not transmitted by any known vector. Plants that contain the viruses started out with the virus. It would not be carried from that diseased plant to other plants. Viruses react like other microorganisms, and their infectability depends on the host and the environment, which determine whether we see symptoms or not. Usually viruses are inhibited, they aren't as active, when temperatures are high so we tend to see rose mosaic virus most often in the springtime when the new leaves are out and then as it gets warmer we tend not to see them as much. Plants do have resistance to these microorganisms. The reaction between the virus and the host will determine the severity of the symptoms. Rose mosaic virus is not a very severe virus. It doesn't apparently harm the plant, and the plant will survive year after year with the virus in it. It doesn't affect the quality or appearance of the flower. Overall, infected plants seem to grow very well. Maintaining healthy plants probably does help the plant, but it's more a case of genetic resistance.

**Tom Branca:** If we want to propagate virus-infected plants conventionally, is there a distance behind the apical meristem or lateral meristem where the virus is absent so cuttings we take will be virus-free?

**Michael Yoshimura:** Viruses spread within the plant via plasmodesmata, and those haven't yet formed in the apical meristem. Viruses also move through the phloem, and it hasn't formed yet in the apical meristem either. Depending on the plant species then the virus will get very close to the apical meristem. Usually when you do meristem culture you grow the plant at an elevated temperature to slow down the growth of the virus and hope it gets farther away from the apical meristem and then excise the apical meristem so you can obtain a plant without the virus. Some chemicals (Ribavirin) have been used to slow down the virus.

**Tom Branca:** What actually makes a species? How do we determine taxonomically what the difference between genus and species is? You said that we can have two plants that look alike phenotypically, but yet genotypically they are somewhat different. From a molecular viewpoint how do you determine what a species is?

**Jeff Wong:** Genetically speaking, speciation and genetics are somewhat different because if you were going to look at genetics and try to determine species is your genetic code and that of a plant are basically the same. Based on that, then, you and the plant are related. So, genetically, in terms of taxonomic classification you can't really deal specifically with that question.

**Margie Friday:** Is there puddling on the floor in the propagation facility you showed?

**Jeremy Bahne:** There is some, but it has been greatly reduced by the compound grading. We haven't grown on those 2 acres of bottom-heat yet in either structure. We have been running water just to see what it does.

**Margie Friday:** Did you put a finish on your cement?

**Jeremy Bahne:** It is finished, but it's not a brushed finish. However, it's rough enough that it's not slippery surface when wet.

**Don Dillon:** Is the weed barrier you mentioned throughout your house, and what surface is underneath?

**Jeremy Bahne:** In the open sections we used Class II road base. On top of that is 4-mil black plastic and then the weed barrier. Basically, that prevents water from going into that area so you can walk on it and we run equipment over it. In the retractable-shade house there is weed barrier on the side without heat and in the glass greenhouse the weed barrier is just on the aisles and, again, there's Class II road base under that.

**Don Dillon:** With the black plastic under the weed barrier, how do you get rid of extra water?

**Jeremy Bahne:** It all runs to the drain. The whole section has a 2% grade to the drain.

## The Best Treatment Combination for Air Layering Litchis<sup>®</sup>

**Michelle Kong**

Department of Horticulture and Crop Science, California Polytechnical University, San Luis Obispo, California 93407

### INTRODUCTION

Litchis (*Litchi chinensis*) are a popular tropical fruit in many Asian countries. In the United States, litchis cost \$3.99–\$7.99 per pound or more depending upon the time of year and the location. Once the litchi tree is established, it can produce 500–1000 pounds of fruit each year, with prime production when it is 20–40 years old. Litchi trees are difficult to propagate. Litchi trees propagated by seed would not have predictable fruit quality because of genetic variation. They would take 10–15 years to set fruit, whereas air layers only take 3–5 years to set fruit. Litchi air layers typically take 3–6 months to root. To find out if roots could be produced more quickly, an experiment was performed on a small litchi orchard at the Calimoya Orchard in Goleta, California in 2005.

### MATERIALS AND METHODS

Three factors were considered as main treatments: (1) with or without hormone treatment, (2) type of wrap/covering, and (3) the type of rooting medium.

Hormex 8 was the hormone treatment used to see if it would produce more roots. Hormex 8 has 0.8% indolebutyric acid (IBA). Two types of wraps were used, rooter pot and foil. According to Norman Beard of Beard's Tropical Nursery, rooter pots have these characteristics: easy removal, reusable, stays firmly in place, and the roots can be observed without disturbing the root system. Foil has the characteristics of: ability to form readily, is easy to use, reflects sunlight, and is cheap.

Three types of medium were used: sphagnum moss, peat moss, and coir (coconut fiber). Sphagnum moss is the dehydrated remains of acid-bog plants and has many desirable characteristics including being lightweight, having the ability to absorb 10–20 times its weight, possessing fungistatic properties to inhibit damping-off of seedlings, and a pH of 3.5–4.0 (Hartmann et al., 2002). Peat moss is made up of "remains of aquatic, marsh, bog, or swamp vegetation, preserved under water in a partially decomposed state" (Hartmann et al., 2002). It has high moisture-holding capacity, pH of 3.2–4.5, and small amounts of nitrogen. According to Santha et al. (1999), "coir may be a substitute for peat moss, it has superior water-holding properties than peat moss and is easier to wet." In addition, coir has natural wetting agents and is less acidic than peat moss, with a pH of 4.5–5.5 and a higher salt content with chloride levels of 200–300 ppm whereas most media have 100 ppm of chloride.

The treatments were arranged in 12 sets to give all possible combinations. Each treatment was replicated 5 times to make 60 experimental units. The treatments were as follows:



**Table 1.** Treatment combination for air layering litchis.

Treatment	Media	Hormex 8	Wrap
1	Sphagnum moss	Yes	Foil
2	Sphagnum moss	No	Foil
3	Sphagnum moss	Yes	Rooter pot
4	Sphagnum moss	No	Rooter pot
5	Peat moss	Yes	Foil
6	Peat moss	No	Foil
7	Peat moss	Yes	Rooter pot
8	Peat moss	No	Rooter pot
9	Coir	Yes	Foil
10	Coir	No	Foil
11	Coir	Yes	Rooter pot
12	Coir	No	Rooter pot

The air layers were performed on a 5-year-old litchi orchard consisting of 19 trees with four cultivars: Brewster, Bengal, Ha-kip, and Mauritius. The branches were girdled on 25 March 2005. One- to three-year-old branches were randomly selected ranging in diameter from  $\frac{1}{2}$  to 1 inch. The branches ranged from 15 to 25 inches long. With a pruning knife, a 1- to  $1\frac{1}{2}$ - inch cut was made about 5 inches above the base of the branch. The bark was peeled off, and with the knife, the cambium layer was scraped off, exposing the xylem. The girdled branches were allowed 3 days to dry out. Meanwhile, the media were soaked in water for 24 h. The coir was leached once to remove some of the chloride.

After 72 h the treatments were applied to the branches. Half the air layers received Hormex 8 powder, applied with a paintbrush, while the other half did not receive any Hormex 8. Half of the experimental units were covered with a rooter pot and the other half were covered with foil. The completed air layers were untouched for 77 days before they were opened and examined for root formation. They were then sealed again and remained on the tree for another 95 days. After 172 days, the air layers were all checked and the ones with roots were cut off for potting.

## RESULTS

On 10 June 2005, each air layer was examined for roots. Two air layers were missing; so of the 58 air layers remaining, 19 of them produced roots (Table 2).

**Table 2.** Rooting results of air layers of *Litchi chinensis* after 77 days.

Number of successful roots	Total possible	Treatment	Rooting (%)	Average root length (inches)	P-value
11	20	Peat moss	55	3.27	0.032
4	19	Sphagnum moss	21	3.50	
4	19	Coir	21	4.25	0.919
11	29	Hormex 8	38	3.77	
8	29	No Hormex	28	3.50	0.291
13	29	Foil	45	3.77	
6	29	Rooter pot	21	3.50	0.041

Because only 19 of the 58 treatments were successful, a Binary Logistics of Regression test was run on Minitab to show the probability of rooting. There was no difference between treatments with Hormex 8 and those without. There was a difference in the probability of roots between the foil and rooter pot: the foil was two times more likely to have roots than the rooter pot. The Binary Logistics of Regression test showed there was a difference between medium type in the probability of rooting. Peat moss showed it was 5 times more likely to root than sphagnum moss and coir. Sphagnum moss and coir showed no difference in results between each other.

After 172 days, on 15 Sept. 2005, the air layers were examined and potted (Table 3). There were a total of 27 out of 58 air layers that had roots.

**Table 3.** Rooting results of air layers of *Litchi chinensis* after 172 days.

Number of successful roots	Total possible	Treatment	Rooting (%)	Average root length (inches)	P-value
11	20	Peat moss	55	7.90	0.420
8	19	Sphagnum moss	42	5.63	
8	19	Coir	42	6.38	0.866
14	29	Hormex 8	48	7.94	
13	29	No Hormex	45	5.66	0.583
16	29	Foil	55	7.49	
8	29	Rooter pot	28	5.74	0.001

Because the number of air layers with roots increased, a Binary Logistics of Regression test was run again. This time there was no difference in the probability of rooting between the hormone treatments used or the type of medium used. Foil covering showed a difference: it did two times better than the rooter pot. A General Linear Model ANOVA Test was run on Minitab to determine the difference in root length between the treatments. Hormone treatment showed a difference in root lengths. Those treated with Hormex 8 had longer roots than those without Hormex 8; the average root length in treatments with Hormex 8 was about 2 inches longer than those without.

## CONCLUSIONS

The results showed that there was a difference between the type of wrap/covering used and the type of medium used. Hormone treatment showed no difference in the probability of rooting. However, Hormex 8 did show a difference in root length: those treated with Hormex 8 had longer roots than those without Hormex 8. Treatments with foil were two times more successful than those using the roofer pot. The medium used showed the most difference: peat moss did the best with the longest average root length at 7.9 inches and it had the most successful and consistent treatments of the three. Over half the treatments that received peat moss had roots by Day 77. Peat moss with Hormex 8 in foil proved to be the best treatment combination for air layering litchis in California.

## LITERATURE CITED

- Hartmann, H.T., D.E. Kester, F.T. Davies, and R.L. Geneve. 2002. Plant propagation, Principles and practices. 7th ed. Prentice Hall: Upper Saddle River, New Jersey.
- Santha, L. and C. Santha. 2005. Facts on coir: Lessons from the past. <<http://www.rolanka.com/index.asp?pg=coirarticle>>.

---

## Propagation of *Arbutus* 'Marina' by Air-Layering<sup>®</sup>

**Celeste Whitlow and David Hannings**

Department of Horticulture and Crop Science, California Polytechnical University, San Luis Obispo, CA 93407

## INTRODUCTION

*Arbutus* 'Marina' is a strikingly attractive California-hybridized shrub grown and sold in nurseries, often pruned into multitrunk or standard form. The appearance of 'Marina' is evocative of the madrone (*A. menziesii*), a powerfully beautiful California native tree. Unlike the madrone, the 'Marina' fits a wide range of landscaping needs and is resilient to most human care. While the madrone is not as adaptable as the 'Marina' and rarely survives outside of its native environment, the 'Marina' can survive in good- or poor-quality soil, in a xeriscape, or in the middle of an irrigated lawn used as a small tree or screening shrub and is a viable option for those who want to echo the California native landscape in their own landscapes.

The higher cost and limited availability of the 'Marina' is primarily because it is recalcitrant to propagation by seed and cuttings. The 'Marina' is available to growers from specialty propagators as micropropagated plantlets, liners from micropropagated plantlets, and liners from cuttings. From our experience, the cost is from \$1.25 to \$1.75 per liner, and the time necessary for liners to reach a saleable 1-gal size is from 6 to 9 months. Local retail and wholesale nurseries routinely find themselves unable to meet the demand for finished 'Marina' standards, multitrunks, and shrubs.

Propagation by air-layering has been successfully used to reproduce species that are not readily propagated by seed or cutting. Air-layering techniques have subtle variations, but in general an incision or wound is made on a plant stem, the bark is removed, a rooting hormone is applied, the stem at the incision is covered by a wad of moisture-retaining material (such as sphagnum moss or rooting rockwool cubes), followed by an occlusive wrap. If the procedure is successful, the plant's natural

## CONCLUSIONS

The results showed that there was a difference between the type of wrap/covering used and the type of medium used. Hormone treatment showed no difference in the probability of rooting. However, Hormex 8 did show a difference in root length: those treated with Hormex 8 had longer roots than those without Hormex 8. Treatments with foil were two times more successful than those using the roofer pot. The medium used showed the most difference: peat moss did the best with the longest average root length at 7.9 inches and it had the most successful and consistent treatments of the three. Over half the treatments that received peat moss had roots by Day 77. Peat moss with Hormex 8 in foil proved to be the best treatment combination for air layering litchis in California.

## LITERATURE CITED

- Hartmann, H.T., D.E. Kester, F.T. Davies, and R.L. Geneve. 2002. Plant propagation, Principles and practices. 7th ed. Prentice Hall: Upper Saddle River, New Jersey.
- Santha, L. and C. Santha. 2005. Facts on coir: Lessons from the past. <<http://www.rolanka.com/index.asp?pg=coirarticle>>.

---

## Propagation of *Arbutus* 'Marina' by Air-Layering<sup>®</sup>

**Celeste Whitlow and David Hannings**

Department of Horticulture and Crop Science, California Polytechnical University, San Luis Obispo, CA 93407

## INTRODUCTION

*Arbutus* 'Marina' is a strikingly attractive California-hybridized shrub grown and sold in nurseries, often pruned into multitrunk or standard form. The appearance of 'Marina' is evocative of the madrone (*A. menziesii*), a powerfully beautiful California native tree. Unlike the madrone, the 'Marina' fits a wide range of landscaping needs and is resilient to most human care. While the madrone is not as adaptable as the 'Marina' and rarely survives outside of its native environment, the 'Marina' can survive in good- or poor-quality soil, in a xeriscape, or in the middle of an irrigated lawn used as a small tree or screening shrub and is a viable option for those who want to echo the California native landscape in their own landscapes.

The higher cost and limited availability of the 'Marina' is primarily because it is recalcitrant to propagation by seed and cuttings. The 'Marina' is available to growers from specialty propagators as micropropagated plantlets, liners from micropropagated plantlets, and liners from cuttings. From our experience, the cost is from \$1.25 to \$1.75 per liner, and the time necessary for liners to reach a saleable 1-gal size is from 6 to 9 months. Local retail and wholesale nurseries routinely find themselves unable to meet the demand for finished 'Marina' standards, multitrunks, and shrubs.

Propagation by air-layering has been successfully used to reproduce species that are not readily propagated by seed or cutting. Air-layering techniques have subtle variations, but in general an incision or wound is made on a plant stem, the bark is removed, a rooting hormone is applied, the stem at the incision is covered by a wad of moisture-retaining material (such as sphagnum moss or rooting rockwool cubes), followed by an occlusive wrap. If the procedure is successful, the plant's natural

auxins (traveling down from the stem tip) and the applied rooting hormone will stimulate rooting at the site of the incision. Once sufficient roots have appeared, the stem is cut from the shrub, the wrapping removed, and the rooted stem is potted in a container. Often, the newly potted air-layered plants are placed under mist or shade for a few weeks to aid in the transition from air-layer to pot-rooted plant.

The purpose of this study was to explore the possibilities of propagation by air-layering as a means to predictably produce large 'Marina' plants in a shorter period of time, as an alternative to relying on purchase of liners.

Secondary issues explored were the response of 'Marina' to artificial long-day conditions (long-day lighting at night) and the impact of inoculation of the moist rooting material with a small amount of medium (with roots) taken from the root zone of the 'Marina' being air-layered.

## MATERIALS AND METHODS

Twelve large, 2-year-old, 15-gal A. 'Marina' were provided by David Fross at Native Sons (Nipomo, California). They were transported to Greenhouse #9 at the CalPoly San Luis Obispo (SLO) Horticulture Unit at the end of Dec. 2004. A hard pruning was performed to induce vigorous auxin-laden new growth. Long-day lighting conditions were initiated on 10 Jan. 2005. The 'Marina' plants were moved to the Courtright shade-house in June.

The layers were made from 1 July 2005 to 30 Sept. 2005. Stem diameters air-layered were from 4.5 to 15 mm. The distance from bark removal (air-layer site) and stem apex ranged from approximately 20 cm to 1 m. In preparation of the air-layer site, the leaves and small branches in the site area were removed. A 1.0 to 2.0-cm strip of bark, completely encircling the stem, was removed. A portion of the sites were left untreated by the Dip 'N Grow<sup>®</sup> hormone preparation. The area without bark was then painted with a mixture of Dip 'N Grow (1.0% indole-3-butyric acid and 1-naphthaleneacetic acid 0.5%) and DipGel (a gel thickener for Dip 'N Grow), both of which were provided by Dip 'N Grow<sup>®</sup>, Inc. for this study. The dilution strengths were 5000, 7500, and 10000 ppm. Application of the hormone mixture was accomplished using a 1-inch paintbrush. The hormone mixture was applied to the distal (closest to the shoot apex) edge of the bark-removal site. A handful of moist green moss was wrapped around the site. Some of the sites' moss was inoculated with approximately 1/2 teaspoon of potting media taken from the plant's root mass, 2–3 inches below the surface of the medium. The green moss was covered by a zip-lock plastic bag (both ends cut out, forming a sleeve, with the zipped opening on one side), secured with 4-inch computer-cable ties, then aluminum foil. The zip-lock opening facilitated nearly effortless "quick-peak" assessments of progress.

Inspections of layer sites were performed at approximately 4- to 5-week intervals. Harvested air-layers were potted in 1-gal containers and placed in CalPoly's mist unit. Some of these were "harvested" by winds. Although none of the wind-harvested layers were fully rooted, those with roots and those with moderate to abundant calus were potted and placed in the mist unit with the fully rooted, harvested layers.

## RESULTS AND DISCUSSION

Harvests of layer sites started in the first week of October 2005. The fully rooted air-layers were originally placed in July, on stem diameters of 7.0–10.0 mm, and all three Dip 'N Grow dilution-strengths were represented in the fully rooted layers.

There were three issues encountered during this study: (1) the learning curve for air-layering technique for this species, (2) the unanticipated heat-loading of the wrapped air-layer sites during the height of summer, and (3) the ferocity of the Santa Ana winds. All three issues produced air-layer site failures, which in a more controlled setting and with a more experienced air-layer technician, would not have occurred. Therefore, the failure rate was falsely elevated over what could be expected in a more appropriate environment.

This study is not complete. It is anticipated that the last of the layers will root or fail by December 2005. The original plans were for the study to extend through winter, which would allow us to assess the impact of long-day lighting on the speed and percentage of air-layer rooting. Unavailability of appropriate greenhouse space prevented the completion of this part of the study, and it is anticipated that no further air-layers will be placed.

Of the layers treated with no hormone, 45 out of 68 (66.2%) failed. Of those that failed, 22 (48%) had been soil inoculated and 23 (51%) had not. The average days to failure was 41.7, with the earliest failure at Day 32 (32 days following the placement of the air-layer) and the latest at Day 96 (due to wind breakage). Twenty-three of the 68 sites (33.8%) did not fail. Of these, eight (34.8%) were soil inoculated, and 65.2% were not. Of those that lived, to date two (8.7%) developed roots (at 37 days).

Of the layers treated with 5000 ppm hormone, 25 out of 64 (39%) failed. Of those that failed, 15 (60%) had been soil inoculated and 10 (40%) had not. Average days to failure was ~38. Five sites were broken by wind. The earliest failure was at Day 31, and the latest was at Day 47. Thirty-nine (60.9%) of the sites have survived. Of those, 18 (46.1%) were soil inoculated and 21 (53.8%) were not. Roots developed on 19, with roots first observed at an average of 72.4 days post air-layer placement. Roots appeared on 48.7% of the survivors and appeared as early as 41 days and as late as 104 days post placement.

Of the layers treated with 7500 ppm hormone, 15 out of 59 (25%) failed. Of those, five (33%) were soil-inoculated and 10 (66%) were not. One broke from the winds. Average days to failure was 49; the earliest failure was noted at Day 34, and the latest at Day 86. Seventy-six percent survived, of which 16 were soil inoculated and 28 were not. Thirteen (28.9%) rooted. Average days to rooting was 61.7 days, with the earliest roots noted on Day 38 and the latest on Day 90.

Of the layers treated with 10,000 ppm hormone, 27 out of 49 (55%) lived, of which 13 were soil-inoculated and 14 were not. Ten of 27 (37%) rooted, with the earliest roots appearing on Day 40 and as late as on Day 96. The average days to root was 70.4.

Callus formation was rated as slight, moderate, and abundant, and all three grades were noted as early as 38 days following air-layer placement. All three levels of callus formation went on to develop roots. The abundant callus formed the largest mass of roots in the shortest time. None of the non-hormone-treated sites developed abundant callus and the majority of abundant and moderate callus formation was on sites treated with either 5000 or 7500 ppm hormone.

On six of the sites that were not treated with rooting hormone, on the stems under the light-occlusive air-layer wrapping, shoots developed on some of the nodes. The nodes where shoots developed were both distal and proximal to the bark-removal site. These shoots were removed as they were encountered in the process of assessing for callus and root formation.

## CONCLUSION

The response of the 'Marina' to air-layering was good, with the first rooted layers harvested about 90 days after placement. The response to the hormone dilutions was rapid and acceptable, with the 5000 and 7500 ppm dilutions consistently producing moderate and abundant callus as early as 38 days post air-layer placement. Stem diameters between 7.0 and 12.0 mm had the best results, with the most abundant callus formation and earliest root formation. The 4.5- to 6.5-mm diameter stems had quick callus formation, but were more inclined to break or otherwise fail. The results of soil inoculation of the moist air-layer material appears equivocal to date, with no consistent trends noted. The 'Marina's had a very gratifying response to long-day lighting, producing exuberant new growth in January, very close to the level of growth seen in the summer. This may indicate a possibility that the 'Marina' might also favorably respond to long-day lighting with callus and root formation at a similar rate and quality as that produced during the summer months. This might indicate that air-layering propagation of *A. 'Marina'* may be possible on a year-round basis, without loss of productivity during the shorter, colder days of winter, if they were long-day lighted and provided adequate warmth during the winter.

---

## Improving Handling and Rooting of *Thunbergia alata*®

Joseph Coelho, David Hannings, J. Wyatt Brown, and Matt Ritter

Department of Horticulture and Crop Science, California Polytechnic State University, San Luis Obispo, California 93410

## INTRODUCTION

*Thunbergia alata*, common name "black-eyed Susan vine," is an increasingly popular ornamental vine named for the black eyes of its miniature flowers. *Thunbergia alata* is commonly propagated by seed and stem-and-two-leaf nodal cuttings. Large-scale cutting production of *T. alata* is performed in Costa Rica by Ball Flora Plant. Many of the cuttings experience leaf disintegration and literal melting usually within the first week of planting, resulting in failure to root and death. A study was launched to examine factors affecting the rooting of *T. alata* Sunny™ Lemon Star black-eyed Susan PPAF vine cuttings.

## MATERIALS AND METHODS

Unless otherwise noted, no cuttings of *T. alata* were treated with rooting hormones in the following experiments.

**Carbohydrates and Rooting.** One hundred-fifty *T. alata* Sunny™ Lemon Star black-eyed Susan cuttings were separated into basal (nodes 1 and 2) and nonbasal (nodes 3 and 4) treatment groups to examine the effect of internodal cutting position on rooting. Hamilton et al. (2002) found that leaf size of *Coleus* cuttings greatly influenced rooting quality. Lemon Star basal cuttings often have larger leaves than nonbasal cuttings. Cuttings were planted in sterile Oasis® cubes, placed in a misting house with bottom heat under intermittent mist at 4 sec mist every 4 min, and propagation survival was recorded after 3 weeks.

**Respiration and Temperature.** The effect of temperature on respiration rate of *T. alata* Sunny™ Lemon Star black-eyed Susan was examined using a static



## CONCLUSION

The response of the 'Marina' to air-layering was good, with the first rooted layers harvested about 90 days after placement. The response to the hormone dilutions was rapid and acceptable, with the 5000 and 7500 ppm dilutions consistently producing moderate and abundant callus as early as 38 days post air-layer placement. Stem diameters between 7.0 and 12.0 mm had the best results, with the most abundant callus formation and earliest root formation. The 4.5- to 6.5-mm diameter stems had quick callus formation, but were more inclined to break or otherwise fail. The results of soil inoculation of the moist air-layer material appears equivocal to date, with no consistent trends noted. The 'Marina's had a very gratifying response to long-day lighting, producing exuberant new growth in January, very close to the level of growth seen in the summer. This may indicate a possibility that the 'Marina' might also favorably respond to long-day lighting with callus and root formation at a similar rate and quality as that produced during the summer months. This might indicate that air-layering propagation of *A. 'Marina'* may be possible on a year-round basis, without loss of productivity during the shorter, colder days of winter, if they were long-day lighted and provided adequate warmth during the winter.

---

## Improving Handling and Rooting of *Thunbergia alata*®

Joseph Coelho, David Hannings, J. Wyatt Brown, and Matt Ritter

Department of Horticulture and Crop Science, California Polytechnic State University, San Luis Obispo, California 93410

## INTRODUCTION

*Thunbergia alata*, common name "black-eyed Susan vine," is an increasingly popular ornamental vine named for the black eyes of its miniature flowers. *Thunbergia alata* is commonly propagated by seed and stem-and-two-leaf nodal cuttings. Large-scale cutting production of *T. alata* is performed in Costa Rica by Ball Flora Plant. Many of the cuttings experience leaf disintegration and literal melting usually within the first week of planting, resulting in failure to root and death. A study was launched to examine factors affecting the rooting of *T. alata* Sunny™ Lemon Star black-eyed Susan PPAF vine cuttings.

## MATERIALS AND METHODS

Unless otherwise noted, no cuttings of *T. alata* were treated with rooting hormones in the following experiments.

**Carbohydrates and Rooting.** One hundred-fifty *T. alata* Sunny™ Lemon Star black-eyed Susan cuttings were separated into basal (nodes 1 and 2) and nonbasal (nodes 3 and 4) treatment groups to examine the effect of internodal cutting position on rooting. Hamilton et al. (2002) found that leaf size of *Coleus* cuttings greatly influenced rooting quality. Lemon Star basal cuttings often have larger leaves than nonbasal cuttings. Cuttings were planted in sterile Oasis® cubes, placed in a misting house with bottom heat under intermittent mist at 4 sec mist every 4 min, and propagation survival was recorded after 3 weeks.

**Respiration and Temperature.** The effect of temperature on respiration rate of *T. alata* Sunny™ Lemon Star black-eyed Susan was examined using a static

system, with cuttings held at 2.2 °C, 7.2 °C, and 20 °C. Pint Mason jars were sealed with 4 cuttings per jar and placed for 1 h at 20 °C and 2 h at 2.2 °C and 7.2 °C. Levels of CO<sub>2</sub> were measured with a gas chromatograph fitted with a CTR-1 column (Alltech). Jars containing cuttings were filled with distilled water and weighed to determine actual headspace. Data was recorded as mg CO<sub>2</sub> per kg·h<sup>-1</sup>.

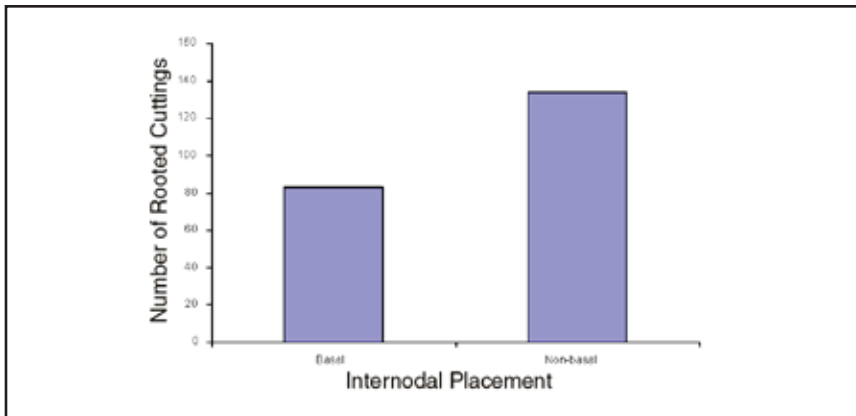
**Temperature and Shipping Potential.** Sixty-eight *T. alata* Sunny™ Lemon Star black-eyed Susan cuttings were placed in permeable vegetable bags at 2.2 °C and 20 °C for 3 days to assess the effect of abusive temperatures during shipment from Costa Rica to the United States. Cuttings were planted in sterile Oasis cubes and placed in a misting house with bottom heat under intermittent mist at 4 sec mist every 4 min. The number of cuttings rooting after 1 week was determined.

**Misting Interval and Rooting.** The effect of intermittent mist duration on cutting survival was examined. Treatments consisted of misting *T. alata* Sunny™ Lemon Star black-eyed Susan cuttings for 4 sec every 4 min for 3 weeks, 4 sec mist every 4 min for 1 week then 4 sec mist every 8 min for 2 weeks, and 4 sec mist every 8 min for 3 weeks. Cuttings were planted in sterile Oasis cubes with bottom heat, and survival was recorded after 3 weeks.

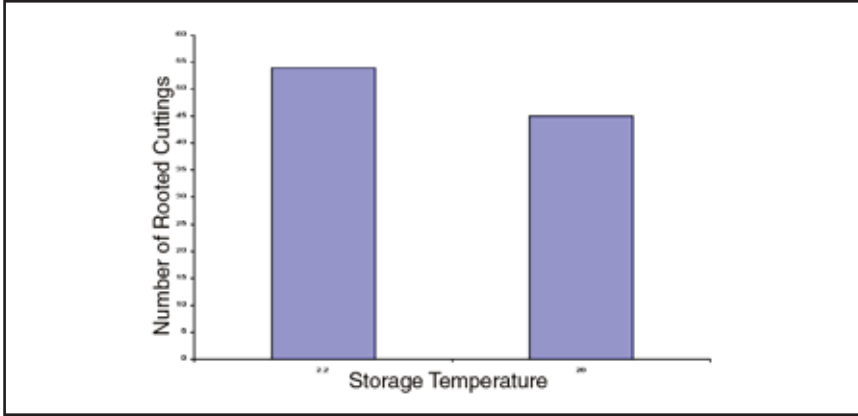
**Hormones and Rooting.** Cuttings of *T. alata* Sunny™ Lemon Star black-eyed Susan were treated with Dip 'N Grow® (1% IBA and 0.5% NAA) at 1 : 5, 1 : 10, and 1 : 20 dilutions; Rootone® (0.2% NAA) dipping powder; or tap water. All cuttings were planted in sterile Oasis cubes and placed under intermittent mist at an interval of 4 sec every 8 min. Bottom heat was applied to the rooting bed. Propagation survival was recorded after 3 weeks.

## RESULTS

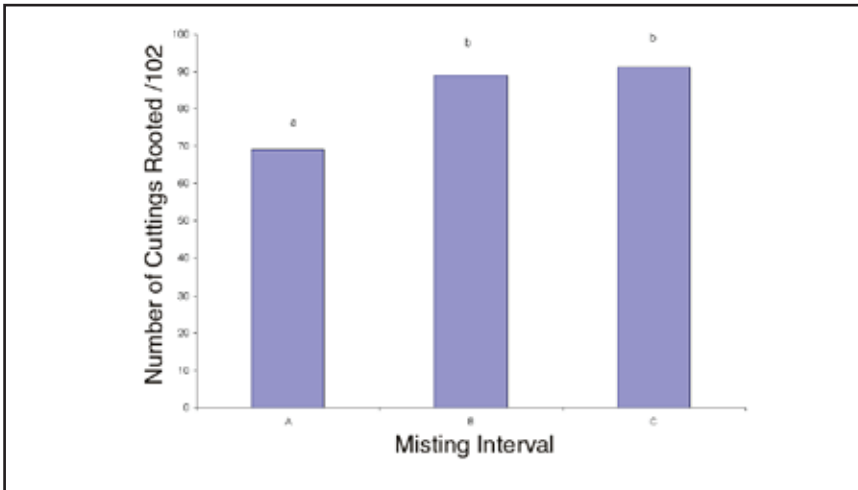
**Carbohydrates and Rooting.** Nonbasal cuttings rooted better than basal cuttings (chi-square analysis  $p = 0.000$ ) (Fig. 1). This was surprising as research had indicated that the larger store of carbohydrates in large-leaf cuttings (basal) could



**Figure 1.** The effect of internodal placement on cutting survival of *T. alata*, Sunny™ Lemon Star black-eyed Susan. Nonbasal cuttings taken at nodes 3 and 4 rooted at a greater rate (chi-square analysis  $P = 0.000$ ) than basal cuttings taken at nodes 1 and 2. Cuttings were placed in a rooting bed with bottom heat for 3 weeks and misted every 4 min for 4 sec. One hundred-fifty cuttings were assessed from each location.



**Figure 2.** The effect of storage temperature on the rooting of cuttings of *Thunbergia alata* Sunny™ Lemon Star black-eyed Susan. Cuttings were stored for 3 days at 2.2 or 20 °C before propagation. The values represent the results after 3 weeks with intermittent misting occurring every 4 min for 4 sec. Sixty-eight cuttings were stored at each temperature.



**Figure 3.** The effect of misting duration on cutting survival of *Thunbergia alata*, Sunny™ Lemon Star black-eyed Susan. These results represent data collected after 3 weeks in mist propagation at variable rates of misting duration. Means with the same letter are not significantly different at the 95% confidence level according to Tukey's Mean Separation Test.

A = 4 sec mist every 4 min for 3 weeks.

B = 4 sec mist every 4 min for 1 week then 4 sec mist every 8 min for 2 weeks.

C = 4 sec mist every 8 min for 3 weeks.

enable these cuttings to root easier (Veierskov, 1988). With *T. alata* 'Lemon Star', it was observed that basal cuttings with larger leaves had a higher incidence of leaf disintegration, which could have led to the lower incidence of rooting.

**Respiration and Temperature.** There was a dramatic increase in respiration rate as temperature increased (Fig. 2). The respiration rate of cuttings at 20 °C (591 mg CO<sub>2</sub> per kg·h<sup>-1</sup>) was 11.5 times higher than that of cuttings at 2.2 °C (23 mg CO<sub>2</sub> per kg·h<sup>-1</sup>). The respiration rate of cuttings held at 7.2 °C was intermediate at 58 mg CO<sub>2</sub> per kg·h<sup>-1</sup>. These results indicate that uneven and/or high temperatures during shipment could deplete the carbohydrate reserves of cuttings, reducing their ability to successfully root.

**Temperature and Shipping Potential.** There was no difference in rooting between cuttings held at 2.2 °C or 20 °C for 3 days, though cuttings held at 2.2 °C tended to root to a greater extent than those held at 20 °C (chi-square analysis  $p = 0.083$ ). Replication of this trial also demonstrated a slight tendency for higher rooting but statistically no difference between the rooting of each group.

**Misting Interval and Rooting.** Cuttings subjected to 4 sec mist every 4 min for 1 week then 4 sec mist every 8 min for 2 weeks, or 4 sec mist every 8 min for 3 weeks had a higher rooting percentage than those cuttings subjected to 4 sec mist every 4 min for 3 weeks (Tukey's Mean Separation Test) (Fig. 3). When cuttings were misted at the shorter frequency (every 4 min), the leaves appeared waterlogged and chlorotic and the leaves disintegrated more rapidly than those misted every 8 min.

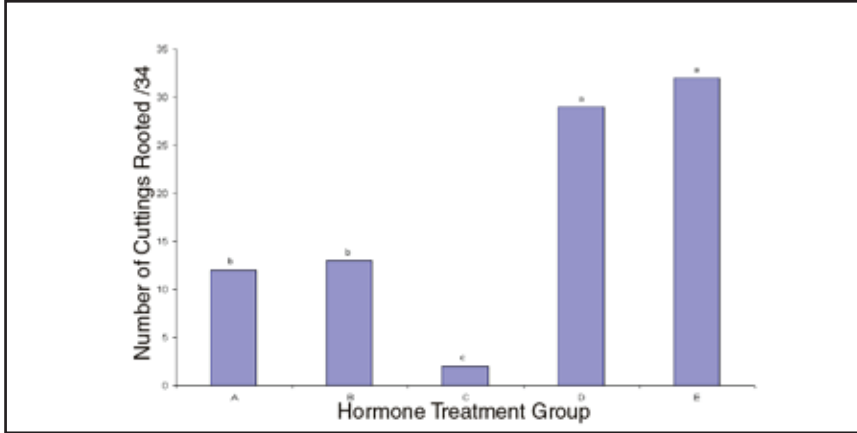
**Hormones and Rooting.** The Dip 'N Grow dilutions appeared phytotoxic to the cuttings, causing yellowing and melting of the leaves and eventual cutting death (Fig. 4). Interestingly, though, cuttings treated with Rootone powder rooted better than the cuttings treated with the Dip 'N Grow dilutions; the Rootone-treated cuttings rooted to the same extent as the cuttings treated with tap water.

## DISCUSSION

There is very little published literature regarding the propagation of *T. alata*, so the rooting problem had to be examined from a practical standpoint. *Thunbergia alata* cuttings tended to root best when taken from the nonbasal nodal position (nodes 3 and 4). This was attributed to less surface area for leaching in the mist and thus less leaf disintegration. Also, it is known that auxin is produced at the shoot tips, so perhaps increased auxin levels in nonbasal cuttings was promoting rooting.

Temperature clearly affected the respiration rate of Sunny™ Lemon Star black-eyed Susan, though it did not appear to affect the rooting of cuttings stored at 2.2 or 20 °C. *Thunbergia alata* cuttings are typically packaged with an ice pack, but the ice packs have been observed to be completely melted upon arrival. Thus, the cuttings may be subjected to relatively high temperatures during transit. The small tendency for cuttings stored at cold temperature to root better does not seem to justify the potential added cost of refrigeration. In addition, it has yet to be determined if *T. alata* is chilling sensitive.

Lemon Star cuttings rooted better when the mist interval was increased from 4 to 8 min. Cuttings were not as waterlogged or chlorotic when the interval was increased, and this was correlated with rooting success. As cuttings with larger



**Figure 4.** Effect of rooting hormones on the rooting of cuttings of *Thunbergia alata* Sunny™ Lemon Star black-eyed Susan cuttings. Cuttings were treated with specified rooting hormones, and rooted cuttings were counted after 3 weeks with bottom heat and intermittent mist at 4 min every 8 sec. Means with the same letter are not significantly different at the 95% confidence level according to Tukey's Mean Separation Test.

A = Dip 'N Grow® 1% IBA, 0.5% NAA at 1 : 5 dilution ratio.

B = Dip 'N Grow 1% IBA, 0.5% NAA at 1 : 10 dilution ratio.

C = Dip 'N Grow 1% IBA, 0.5% NAA at 1 : 20 dilution ratio.

D = Rootone® 0.2%NAA.

E = Tap water.

leaves tended to not root as well as those with smaller leaves, increasing the misting interval may promote higher rooting of larger-leaf cuttings.

Ball Flora Plant does not recommend the use of hormones when propagating *T. alata* cuttings. The study comparing Dip 'N Grow to Rootone or tap water indicates that auxin does not increase rooting, which supports Ball's recommendation.

Research on *T. alata* propagation will be conducted this spring analyzing the effects of plant growth regulators on stock plant cutting production and the effects of water quality and droplet size on rooting.

#### LITERATURE CITED

- Hamilton, C.J., E. Emino, and C. Bartuska.** 2002. The influence of cutting size, leaf area, and shipping on *Coleus* cutting quality parameters including rooting. Univ. Florida. Florida State Hort. Soc. Proc. 115:134-136.
- Veierskov, B.** 1988. Relations between carbohydrates and adventitious root formation, p. 70-78. In: T.D. Davis, B.E. Haissig, and N. Sankhla (eds.). Adventitious root formation in cuttings. Dioscorides Press, Portland, Oregon.

## General Session II: Question and Answer Session®

**Dieter Louter:** Did you girdle all the way around?

**Michelle Kong:** We went all the way around.

**Dieter Louter:** Did you use only Hormex #8?

**Michelle Kong:** Yes.

**Dieter Louter:** Do you suspect you would get better and/or faster rooting in a warmer area?

**Michelle Kong:** Probably.

**Richard Criley:** How did you apply your rooting compound? Was it to the stem or the medium? Did you apply it to the girdled area or above? When did you apply rooting compound in relation to making the girdle?

**Michelle Kong:** For the litchi, we waited 3 days after girdling to apply a powder form of rooting compound. We applied it onto the girdled area.

**Celeste Whitlow:** For the *Arbutus*, I made a girdling incision and immediately used a small paintbrush to apply rooting compound all the way around mainly on the top of the girdled area.

**Arne Andersen:** Have you looked at any treatments of stock plants to improve rooting?

**Joe Coelho:** I've done quite a bit of work with stock plants with much of it trial and error just trying to figure out how to grow the plant. I found I could control growth pretty well by controlling irrigation until the soil dries out. I've also considered doing a harvest trial, analyzing the effects of plant growth regulators. One material in particular, Florel, chemically removes flowers so I would analyze that as a treatment for stock plants. The chemical removal of flowers could possibly increase carbohydrates of the cuttings. I've also looked at cutting position, basal versus non-basal. That's not really manipulation of the stock plant, but was analyzed as a stock plant experiment.

**Gene Blythe:** You mentioned using a thickening agent in your rooting solution. Can you tell us what that was and what concentration you used?

**Celeste Whitlow:** It was actually provided by the Dip 'N Grow people. It's a polysaccharide-thickening agent. It takes very little of it to thicken solutions.

**Gene Blythe:** It sounds like you were preparing two-node cuttings of *Thunbergia*. Can you tell us how you prepared them below the bottom node? Do they root along the nodes or on the cut surface of the stem?

**Joe Coelho:** The cuttings rooted at the cut surface. They are typically two-leaved, single-node cuttings.

**Tom Branca:** Did you try using only the gel-like thickener on any of the layers?

**Celeste Whitlow:** Yes. On the layers without any hormone some callus formed, but they did not go on to root. A concentration of 10,000 ppm was too high with 5000–7500 ppm best.

**Sheila Bhattacharya:** What kinds of temperatures are the *Thunbergia* cuttings exposed to coming from Costa Rica?

**Joe Coelho:** The box recommends maintaining a temperature between 45–50 °F (7–10 °C). I've requested cutting shipments with temperature records inside the box, but that hasn't happened yet. It's probably most important for orders shipped in the hotter spring months.

**John Scholgren:** What branch diameter seems to be best for layering *Arbutus*?

**Celeste Whitlow:** I made layers on branches that ranged in diameter from 4.5 to 16 mm. The best rooting occurred on branches that were between 7 and 12 mm.

**Germaine Boivin:** Have you made trials with RootShield in the soil mix?

**Bill DeVor:** We started using RootShield on vegetable transplants. To this day we use RootShield on everything we produce at Greenheart. It's become a standard ingredient in our soil mixes for vegetables, poinsettias, or roses. In the beginning we did a lot of trials, and I was using quite a few fungicide drenches to solve my problems in the beginning. For us, RootShield made a night-and-day difference.

**Gene Blythe:** Could you repeat the concentration of Rhizopon you use and are there any rose cultivars that do not require auxin treatment?

**Bill DeVor:** On roses I consider rooting hormone insurance. I think we can root all of them without rooting hormone. On shrubs and landscape selection I would say about half I can root without rooting hormone with the other half requiring it. We use 1000 ppm IBA, Rhizopon AA, the pink label.



## Disease and Pest Avoidance and Control in Cutting Production<sup>®</sup>

**Gail Shafer**

Ball FloraPlant, 725 Zenon Way, Arroyo Grande, California 93420

### INTRODUCTION

Viruses, bacteria, fungi, and insect pests adversely affect cutting production, and it pays to avoid and/or control them. Why are we concerned with diseases in cutting production? Aesthetics is one reason. We deal in ornamental products, and our customers would have a hard time selling virus-infected, symptomatic plants. We ship to many countries around the world and have to meet each country's phytosanitary requirements prior to shipping. The presence of disease may affect a plant's ability to root, grow, and flower in a satisfactory manner. In the worst case these infections can lead to plant death.

Why are we concerned with insect pests? Again, aesthetics is important to our customers. Thrips-riddled flowers and foliage is a hard sell. Shipping to other countries we have to meet their import requirements. Insects can transmit some diseases very efficiently.

### DISEASE AVOIDANCE AND CONTROL

Disease avoidance and control can be summed up with the mantra "start clean, stay clean." The important points to discuss for virus and bacteria are starting clean, testing, handling logistics, and rouging. Fungi points will include starting clean, growing environment/culture, and fungicides.

**Virus and Bacteria.** To start clean, all elite (parent) stock originates from tissue culture and is renewed annually. Taxa are introduced to tissue culture through heat treatment and meristem culture. Heat treatment consists of growing plants in a growth chamber at elevated temperatures (90–100 °F), and the meristem is harvested and put into culture. The concept is the plant meristem outgrows the virus and is clean. This works very well for most viruses. Constant monitoring of elite stock ensures quality. Testing for virus currently consists of enzyme-linked immunosorbant assay (ELISA) and polymerase chain reaction (PCR) methods. Enzyme-linked immunosorbant assay is very useful to detect many major viruses but is titer dependant. A virus may be latent with low titer and ELISA testing might not detect it. The PCR is nucleic acid based testing that detects sequences occurring in specific viruses, replicates the sequences, and makes them visible on a gel. There are various other methods to detect bacteria and fungi. Here is an example of harvesting material for an ELISA or PCR test. First the harvest tool is sterilized with alcohol and flaming. Second, leaf material is harvested using the sterilized tool and gloves. Gloves are changed between each taxon. Finally, we have the leaf sample in an Eppendorf tube. Many viruses are mechanically transmitted. One potential route is plant-to-plant contact. Cutting stock plants must be maintained so they are not touching variety to variety. In the case of petunia and tobacco mosaic virus (TMV) we go to the extreme of isolating each variety with plastic curtains: a very inefficient use of bench space, but effective at keeping the individual plant clean.

Another route is tools to plant. There are various ways to sterilize tools between varieties, but that is time consuming and not 100% effective. A viable method is to have individual harvest tools for each variety. Note the plants have ample space between them and separate knife or scissors and the harvester is wearing a lab coat and gloves. This leads us to the potential of people-to-plant contamination. To minimize this, lab coats are worn and kept in the same greenhouse to prevent contamination greenhouse to greenhouse. Footbaths are used upon entering and exiting a stock greenhouse. Workflow from cleanest to dirty is followed daily. Gloves are used whenever handling cutting stock plant material, harvesting, sticking, transplanting, and moving. Some viruses are very difficult to eliminate even using heat treatment/meristem culture. The most effective way to control these viruses is to discard symptomatic plants immediately.

**Fungi.** To avoid fungal infection the initial step is the same as that for virus and bacteria: start clean. Unlike virus and bacteria, fungi can generally be controlled with the growing environment. For example a common method to control powdery mildew is to heat the greenhouse and vent when the humidity reaches 80%. The best prevention method is to provide the best growing culture for the plant. This includes proper irrigation frequency, pH, and nutrient ratios in the media. If you are not able to control fungus with environment and culture there are many preventative and curative fungicides available.

#### **PEST AVOIDANCE AND CONTROL**

Pest avoidance has the same beginning as disease avoidance. Start clean with material that is renewed annually. A very effective method of avoidance is exclusion. This can be accomplished with insect screening installed over vents or sidewalls. Exclusion can also be provided using positive pressure cooling. Positive pressure fans draw outside air across an evaporative cooling pad and distribute this cool air through the house via a convection tube. Hot air is released through the ridge vent. Opening a door results in air moving out of the greenhouse and prevents insects from migrating inside. Not all insects are excluded so scouting and detection are an integral part of a successful program. Along with scouting there are many effective insecticides that can prevent or bring insect populations to a tolerable threshold. These insecticides can be applied as high-volume hydraulic, low-volume, and granular systemics.

#### **CONCLUSION**

**Diseases.** Start clean, use routine testing, understand handling logistics, rogue symptomatic plants, control with growing environment and culture, or apply pesticides when necessary.

**Insect Pests.** Start clean, exclude, detect, and treat with insecticides when necessary.

## Trials with Natural Growth Promoting Products®

**John Keller**

Monrovia Growers, P.O. Box 1385, Azusa, California 91702-1385

### INTRODUCTION

Commercial nurseries are often approached by companies promoting products that enhance plant growth. These may be derived from natural products such as seaweed extracts, fish waste, humic substances, vitamins, etc. Various seaweed extracts are currently on the market and have been shown to increase root development, improve plant growth, and increase yield. Humic substances are commercially available and are reported to improve nutrient uptake and promote rooting. It is important to carefully test these products in order to assess their true value under production nursery conditions. We have tested natural growth-promoting products with varying results. This report summarizes the results of several trials with these types of products.

### TRIAL 1: EFFECT OF HUMATE ON TOMATO, MUSTARD, AND LUPINE GROWTH

Potting soil, sand plus fertilizers, and sand without fertilizers were amended with 10 lb/yd<sup>3</sup> of two commercially available humate products. An additional set of each growing medium was not amended with humate. The potting soil was the general purpose potting soil used at Monrovia Growers, Azusa, California. The sand plus fertilizers contained the same pre-plant fertilizers used in the potting soil.

Tomato, mustard, and lupine seeds were sown into plug trays on 16 Dec. 2004. One month later, uniform seedlings were transplanted into the soil treatments in 4-inch pots. Plants were held in a propagation greenhouse at Azusa, California and watered with fortified irrigation water (nominal 50 ppm N and 75 ppm K). There were 10 plants per taxon per treatment arranged in a completely randomized design by plant species. Species were not randomized. Shoot fresh weight was determined on 28 Feb. 2005 for tomato and mustard and on 26 April 2005 for lupine.

At the end of the experiment, humates were extracted from several soil treatments and potting soil ingredients with 0.1 N NaOH followed by precipitation with concentrated sulfuric acid. The potting soil treatments were also extracted with 6 N HCl and the extract analyzed by atomic absorption spectrophotometry for Ca, Cu, Fe, K, Mg, Mn, and Zn. The extract was also analyzed for P by the ammonium molybdate colorimetric method.

The addition of humate to potting soil did not significantly improve growth of tomato, mustard, or lupine (Table 1). Humate 1 actually reduced growth of mustard. It was noted that many of the plants in the humate 1 treatment were more chlorotic than the other treatments. Analysis of the soil at the end of the experiment indicated that potting soil plus humate 1 contained 5 and 16 times the normal level of zinc and copper, respectively (Table 2). Therefore, humate 1 must have contained considerable amounts of these elements, which probably was toxic to the plants, resulting in chlorosis and reduced growth.

**Table 1.** Growth of tomato, mustard, and lupine in soil media amended with humates. Results are expressed as a percent of the potting soil treatment.

Treatment	tomato	mustard	lupine
Potting soil	100 a*	100 a	100 ab
Potting soil + humate 1	80 ab	66 b	113 ab
Potting soil + humate 2	88 ab	97 a	138 ab
Sand + fertilizer	32 e	53 bc	111 ab
Sand + fertilizer + humate 1	45 de	51 bc	110 ab
Sand + fertilizer + humate 2	69 bc	55 bc	141 a
Sand	57 cd	33 c	68 b
Sand + humate 1	51 cde	32 c	82 ab
Sand + humate 2	44 de	32 c	86 ab
Significance of F =	26	22	2.5
Treatment effect $P > F =$	< 0.0001	< 0.0001	0.016

\*Values in the same column followed by the same letter are not significantly different by the Tukey-Kramer test at  $P = 0.05$ .

**Table 2.** Analysis of potting soil with humate addition. Soil was extracted with 6N HCl and analyzed by ammonium molybdate colorimetric method for P, and by atomic absorption spectrophotometry for all other elements. Salinity was measured on a saturated paste extract.

Treatment	pH	Salinity mmho·cm <sup>-1</sup>	P	K	Ca (lb/ycd <sup>3</sup> )	Mg	Fe	Mn	Zn (oz/ycd <sup>3</sup> )	Cu
Potting soil	4.5	0.20	0.80	1.4	7.9	2.5	3.7	3.0	1.4	0.85
Potting soil + humate 1	6.1	0.75	0.90	1.6	7.4	2.3	3.7	3.8	7.1	1.4
Potting soil + humate 2	6.6	0.26	0.83	1.3	8.3	2.5	3.9	3.3	1.8	2.3

Plants in sand treatments generally did not grow as well as those in potting soil. Humate 2 added to sand plus fertilizer significantly improved growth of tomato, but in all other cases there was no effect of humate addition to sand.

Some of the treatments and materials used in this project were analyzed for humate (Table 3). Potting soil, bark, and compost contain considerable amount of humate even without any added humate. In comparing the humate extracted from the sand Treatments 4, 5, and 6, it can be seen that there is essentially no difference between the “blank” (Treatment 4) and humate 1 (Treatment 5). This was immediately apparent when the samples were extracted because the extracts from both of these treatments were almost colorless, whereas the extract from humate 2 (Treatment 6) was dark black in color. Humate 1 apparently had little or none of the most easily available humate fractions. The high levels of humate in typical potting mix materials and the low availability of humate 1, may explain the lack of a growth response in this trial.

**Table 3.** Humate analysis of soil mix or soil mix ingredients. Humate was extracted with 0.1 N NaOH followed by precipitation with concentrated sulfuric acid.

Treatment or soil mix component	Theoretical amount of humate added* (lb/yd <sup>3</sup> )	Amount of humate analyzed (lb/yd <sup>3</sup> )
Potting soil	0	21
Potting soil + humate 1	4.5	12
Potting soil + humate 2	0.6	28
Sand + fertilizer	0	7.4
Sand + fertilizer + humate 1	4.5	8.4
Sand + fertilizer + humate 2	0.6	19
Fir bark	--	11
Compost	--	9.4
Peat moss	--	5.1

\*Humate added based on percent humate in humate product 1 and 2 as provided by manufacturer and an addition rate of 10 lb/yd<sup>3</sup>.

### TRIAL 2: SUPPRESSION OF PHYTOPHTHORA DAMPING-OFF BY HUMATE, PHOSPHITE, AND TRADITIONAL CHEMICAL FUNGICIDES

Snapdragon seeds were germinated in a flat. Inoculum was prepared by floating *Phytophthora cinnamomi* cultures in water overnight to release zoospores. On 16 Sept. 2004 seedlings were dipped in the zoospore suspension, then planted in 32-cell plug trays containing the standard potting mix used at Monrovia Growers, Azusa. The treatments listed in Table 4 were applied either by pre-mixing the product into the soil or as a drench after planting. Only one application of each product was made. There were three replicate 32-cell trays per treatment arranged in a completely randomized design. Plant mortality was recorded on 3 Nov. 2004.

**Table 4.** Efficacy of humate, phosphorous acid, and fungicide products on *Phytophthora* damping-off control in snapdragons.

Treatment	Disease incidence* (% seedling death)
Control	44 ab
Humate products:	
Humate product 3, 8-4-8, drenched at 2 oz/gal	28 bc
Humate product 4, 0-2-0, incorporated at 8 lb/yd <sup>3</sup>	18 cd
Humate product 5, 1-0-0 drenched at 2 oz/gal	10 d
Humate product 6, 8-8-8, incorporated at 8 lb/yd <sup>3</sup>	50 ab
Phosphorous acid products:	
Formula 1, drenched at 1 qt/100 gal	8.3 de
Fosphite, drenched at 2 qt/100 gal	17 d
AgriFos, drenched at 2 qt/100 gal	2.1 e
Traditional chemical fungicides:	
Stature, drenched at 6.4 oz/100 gal	3.1 e
Subdue, drenched at 1 fl oz/100 gal	1.0 e

\*Treatment means followed by the same letter did not differ significantly ( $P = 0.05$ ) as determined by Fisher's pairwise comparisons.

The traditional chemical fungicides and one of the phosphorous acid products had the lowest disease incidence and gave better disease control than the humate materials. Disease incidence was significantly less in two of the four humate treatments (Table 4). Humates are known to serve as a food source for soil microorganisms. Therefore these products may have stimulated the growth of soil microorganisms and thereby increased the disease suppressiveness of the soil. Alternatively, disease may have been suppressed because of more vigorous plant growth from the fertilizer value of these materials. A third possibility is that high soluble copper may have suppressed pathogen development as these products were from the same manufacturer as humate 1 in Trial 1.

### TRIAL 3: EFFECT OF KELP EXTRACT ON ROOT GROWTH OF *CUPRESSUS*

One-gal *Cupressus sempervirens* 'Monshel', Tiny Tower® Italian cypress PP12933 were obtained from production stock at Monrovia Growers, Visalia, California in Oct. 2001. Plants received six kelp extract applications according to the manufacturer's instructions: Two drench applications and four foliar spray applications between 26 Oct. 2001 and 9 April 2002. The experiment was arranged in a randomized complete block design, with 30 plants per block per treatment and five replicate blocks.

Plants were evaluated about 4 weeks after the 3rd and 6th application. Three individual plant subsamples were collected from the center of each block on each evaluation date. Soil was washed-off the root ball and the root system was subjectively rated from 1 to 10 with 1 representing a weak root system with no new root growth, and 10 representing a vigorous root system with large amounts of new growth. The roots were then cut-off from the main stem, blotted dry, and weighed. The belowground portion of the crown was not included in the root fresh weight determination.

Root growth did occur during the experiment as there was a seven-fold increase in fresh root weight between January and May 2002 (Table 5). However, there was no improvement in root growth in plants treated with kelp extract compared to the control.

**Table 5.** Effect of kelp extract on root growth of *Cupressus sempervirens* 'Monshel', Tiny Tower® Italian cypress PP12933.

	76 days after first application		189 days after first application	
	Root rating	Root fresh weight (g/plant)	Root rating*	Root fresh weight (g/plant)
Untreated control	4.9 ns**	5.5 ns	6.1 ns	39 ns
Kelp extract	6.0 ns	6.7 ns	5.3 ns	39 ns
Significance of treatment effect	F = 1.3 P > F = 0.31	F = 1.3 P > F = 0.31	F = 4.6 P > F = 0.10	F = 0.073 P > F = 0.80

\* Roots rated from 1 to 10 with 1 representing a weak root system with no new root growth, and 10 representing a vigorous root system with large amounts of new growth.

\*\* ns = not significant.



#### TRIAL 4: EFFECT OF NATURAL GROWTH-PROMOTING PRODUCTS AND IRON CHELATE ON COLOR AND ROOT GROWTH OF *GARDENIA*

Uniformly chlorotic plants of *Gardenia jasminoides* 'Veitchii' were selected from production stock at Monrovia Growers, Visalia, California and placed in 55% shade under normal fertigation (nominal 50 ppm N, 75 ppm K). Treatments listed in Table 6 were applied as a drench on 17 April, 29 April, and 22 May 2002. There were 10 individual plant replicates per treatment arranged in a completely randomized design. Plants were rated for color on 12 June 2002 on a scale of 1 to 10 with 1 representing complete chlorosis and 10 representing dark green foliage. Five randomly selected plants per treatment were evaluated for fresh root weight on 6/19/02.

Drenches of Sprint 330 iron chelate and mycorrhiza plus Sprint 330 resulted in significantly better plant color than mycorrhiza alone (Table 6). Fumigated mycorrhiza was included in the trial to determine if the potential benefit was caused by biotic or abiotic factors in the mycorrhizal formulation. There was no difference between mycorrhiza and fumigated mycorrhiza. The other natural products tested had varying effects on plant color. None of the products had color ratings equal to or better than the treatments containing iron chelate. Treatments did not affect root weight.

**Table 6.** Effect of natural growth-promoting products and iron chelate on color and root growth of *Gardenia jasminoides* 'Veitchii'.

Treatment	Color rating*	Fresh root weight (g/plant)
Untreated control	4.2 bc**	28 ns
Mycorrhiza + Sprint 330	5.3 ab	23 ns
Mycorrhiza	3.5 c	28 ns
Fumigated mycorrhiza	3.9 bc	25 ns
Sprint 330	6.0 a	24 ns
Humic acid	4.2 abc	26 ns
Fulvic acid	3.9 bc	22 ns
Kelp extract 1	3.9 bc	25 ns
Kelp extract 2	4.2 bc	27 ns
Biostimulant mixture	4.3 abc	25 ns
Significance of treatment effect	F = 3.9 P > F = 0.0003	F = 0.71 P > F = 0.69

\* Color rated on a scale of 1 to 10 with 1 representing complete chlorosis and 10 representing dark green foliage.

\*\*Means followed by the same letter are not significantly different at P = 0.05 by the Tukey-Kramer test. ns = not significant. ANOVA and mean separation performed on square root transformed data.

### TRIAL 5: EFFECT OF NATURAL PRODUCTS ON ROOTING OF CAMELLIA CUTTINGS

Four cultivars of camellia cuttings were dipped in Dip 'N Gro and stuck in rooting medium amended with the treatments indicated in Table 7. There were four replicate flats per treatment per cultivar, each containing 56 rose pot liners. Flats were arranged in a completely randomized design with each cultivar grouped together in a separate experiment. Plants were placed under intermittent mist without bottom heat at Monrovia Growers, Visalia, California. Five liners were selected from each replicate after a majority of the cuttings had rooted and root fresh weight was determined. Most cuttings had not produced any new top growth at the time of sampling. There was some variability in the size of cuttings and therefore liners were not randomly selected for sampling, but rather plants were selected to be approximately the same size across all treatments. Obviously dead or damaged plants, or plants on the edges of the bed were not sampled.

There was no significant treatment effect ( $P = 0.05$ ) on fresh root weight in three out of four cultivars (Table 7). *Camellia japonica* 'Debutante' was the only cultivar to show significant treatment differences and the control was the best.

**Table 7.** Effect of natural products on root weight of *Camellia* cuttings. Results are expressed as a percent of the untreated control.

Treatment	Root fresh weight				
	<i>Camellia</i> 'Winter's Fire'	<i>C. japonica</i> 'Debutante'	<i>C. japonica</i> 'Kramer's Supreme'	<i>C. × vernalis</i> 'Yuletide'	Average all cultivars
Control	100 a*	100 a	100 a	100 a	100
Mycorrhiza 1	96 a	67 b	54 a	37 a	63
Fumigated mycorrhiza 1		32 cd		87 a	60
Mycorrhiza 2	75 a	57 bc	75 a	102 a	77
Mycorrhiza 3		40 cd			40
Kelp extract	60 a	40 cd	91 a	45 a	59
Humic acid	63 a	25 d	170 a	88 a	87
Significance of F =	2.3	3.9	2.6	1.4	
Treatment effect $P > F =$	0.11	0.0092	0.077	0.31	

\* Means followed by the same letter are not significantly different at  $P = 0.05$  by the Tukey-Kramer test.

**Table 8.** Effect of growth-promoting products on fresh root weight of 1-gal *Camellia* cultivars. Results are expressed as a percent of the untreated control.

Treatment	<i>C. japonica</i>					Average all cultivars
	<i>C. japonica</i> 'Debutante'	<i>C. japonica</i> 'Spring's Promise'	<i>C. japonica</i> 'Monke' Swan Lake™	<i>C. japonica</i> 'Kumasaka'	<i>C. japonica</i> 'Nuccio's Gem'	
Control	100	100	100	100	100	100
Kelp extract 1	159	110	99	106	111	117
Kelp extract 2	167	140	81	150	126	133
Humectant	153	90	112	97	88	108
Monoammonium phosphate	92	83	80	94	79	86

### TRIAL 6: EFFECT OF NATURAL GROWTH-PROMOTING PRODUCTS ON ROOT GROWTH OF ONE-GAL-LON *CAMELLIA*

Five camellia cultivars were selected from production stock at Monrovia Growers Azusa, California and placed in 55% shade. Plants were drenched 6 times at monthly intervals with the products indicated in Table 8. There were 10, 1-gal plants per cultivar per treatment. Treatments were not randomized. At the end of the experiment on 24 Oct. 2002, five representative plants were selected from each treatment and each cultivar and the fresh root weight was determined.

Averaged over all five cultivars, the seaweed extracts appeared to improve root growth to some degree (Table 8), but results were not consistent across all cultivars. Surprisingly, all five cultivars had lower root weights when treated with monoammonium phosphate compared to the untreated control. Phosphorus is commonly thought to promote root growth.

### DISCUSSION

The results of these trials indicate limited benefit from natural growth promoting products under the cultural conditions used at a commercial nursery. Commercial nurseries strive to provide adequate water and nutrients to plants in order to promote healthy plant growth. Conditions of plant stress are avoided. Some growth-promoting products are proven in sports turf or in in-ground planting, where there is little or no organic component in the growing medium. Most container nursery soils, on the other hand, are highly organic and naturally contain high levels of humates. Although relatively high rates of humate addition were used in these trials, it may be necessary to use even higher rates in order to obtain a growth response.

## Selection of Mycorrhizal Fungi for California Native Plants®

**Lea Corkidi, Mike Evans, and Jeff Bohn**

Tree of Life Nursery, P.O. Box 635, San Juan Capistrano, California 92693

The main objective of mycorrhizal inoculation at the Tree of Life Nursery is the propagation of healthy seedlings and cuttings of California native plants suitable to be transplanted in ornamental home gardens and restoration and revegetation sites. The symbiotic association with arbuscular mycorrhizal fungi improves the ability of plants to cope with environmental stress by facilitating nutrient uptake (Smith and Read, 1997), by increasing tolerance to drought and salt stress (Auge, 2001), and resistance against soil pathogens (Azcon-Aguilar et al., 2002), and by enhancing soil aggregation (Caravaca et al., 2002).

In contrast to native ecosystems where mycorrhizas are so common, soilless mixes used in nurseries for plant propagation do not contain propagules of mycorrhizal fungi (Azcon-Aguilar and Barea, 1997). To incorporate mycorrhizal technology in nursery conditions it must be kept in mind that mycorrhizal associations are three-way interactions between plants, fungi, and growing media (Brundrett et al., 1996). Since the infectivity and effectiveness of a particular mycorrhizal fungus varies with the plant and the growing conditions (Corkidi et al., 2004; Corkidi et al., 2005), the successful application of mycorrhizal inoculum is related to the choice of potting mixes, fertilizers, and pesticides, as well as to the screening and selection of functionally compatible plant-fungal associations (Turnau and Haselwandter, 2002).

### LITERATURE CITED

- Auge, R.M.** 2001. Water relations, drought and vesicular-arbuscular mycorrhizal symbiosis. *Mycorrhiza* 11:3–42.
- Azcon-Aguilar, C.** and **J.M. Barea.** 1997. Applying mycorrhizal biotechnology to horticulture: Significance and potentials. *Sci. Hort.* 68:1–24.
- Azcon-Aguilar, C., M.C. Jaizme-Vega,** and **C. Calvet.** 2002. The contribution of arbuscular mycorrhizal fungi to the control of soil-borne plant pathogens, p. 187–197. In: S. Gianinazzi, H. Schuepp, J. M. Barea and K. Haselwandter (eds.). *Mycorrhizal technology in agriculture: From genes to bioproducts.* Birkhauser Verlag, Switzerland.
- Brundrett, M., N. Bougher, B. Dell, T. Grove,** and **N. Malajczuk.** 1996. Working with mycorrhizas in forestry and agriculture. *ACIAR Monograph 32.* Canberra, Australia.
- Caravaca, F., J.M. Barea, D. Figuroa,** and **A. Roldan.** 2002. Assessing the effectiveness of mycorrhizal inoculation and soil compost addition for reforestation with *Olea europaea* subsp. *sylvestris* through changes in soil biological and physical parameters. *Appl. Soil Ecol.* 20:107–118.
- Corkidi, L., E.B. Allen, D. Merhaut, M.F. Allen, J. Downer, J. Bohn,** and **M. Evans.** 2004. Assessing the infectivity of commercial mycorrhizal inoculants in plant nursery conditions. *J. Environ. Hort.* 22(3):149–154.
- Corkidi, L., E.B. Allen, D. Merhaut, M.F. Allen, J. Downer, J. Bohn,** and **M. Evans.** 2005. Effectiveness of commercial mycorrhizal inoculants on the growth of *Liquidambar styraciflua* in plant nursery conditions. *J. Environ. Hort.* 23(2):72–76.
- Smith, S.E.** and **D.J. Read.** 1997. *Mycorrhizal symbiosis.* Academic Press, Cambridge, U.K.
- Turnau, K.** and **K. Haselwandter.** 2002. Arbuscular mycorrhizal fungi, an essential component of soil microflora in ecosystem restoration, p. 137–149. In: S. Gianinazzi, H. Schuepp, J. M. Barea, and K. Haselwandter (eds.). *Mycorrhizal technology in agriculture: From genes to bioproducts.* Birkhauser Verlag, Switzerland.

### General Session III: Question and Answer Session®

**Nevin Smith:** I've heard anecdotally about the toxic effects of nursery soil when it's relatively fresh because of the phenols in the various barks and in our case, redwood sawdust, on mycorrhizae, and I wonder whether you've found it pays to delay mycorrhizae inoculation for weeks or months or have you found no effect with the VAM8?

**Lea Corkidi:** It's a complicated situation with the different mycorrhiza, the types of fertilizer being used, etc. and all of them can have an effect, but I don't know of any general effect that any particular container medium can have.

**Charles Heuser:** I have a question about disease transmission. I only thought about it when you made an off-hand comment and that was that one mycorrhizal organism can infect more than one plant. Yesterday, we heard how viruses could be translocated throughout the plant. Is there any work on the transmission of viruses from one plant to another plant where there was one mycorrhizal agent on both of them?

**Lea Corkidi:** Mycorrhizae are very funny organisms. The hyphae are not septate so the nuclei of the fungus are traveling around in the hyphae, and therefore, there are many mycorrhizal fungi in one plant, particularly with vesicular arbuscular types. They found this only by molecular techniques. It's difficult to separate species, but you can separate genera because some form vesicles and some don't. I've not heard of viruses being transmitted via mycorrhizae.

**Dale Pollock:** Are there organic fertilizers in the soil mix?

**John Keller:** It contained inorganic, coated-type, slow-release fertilizer. It had compost in it which has quite a bit of nutrition as well.

**Richard Criley:** Have you worked with any materials that contain gibberellins and/or cytokinins that supposedly stimulate growth quite a bit?

**John Keller:** Yes, we have worked with some of those. Most didn't result in as much benefit as manufacturer examples had shown. However, a few did seem to have some beneficial effect, but we're currently not using any of them.

## Best Management Practices at Monrovia Growers to Prevent the Introduction and Spread of *Phytophthora ramorum*®

**John Keller**

Monrovia Growers, P.O. Box 1385, Azusa, California 91702-1385

*Phytophthora ramorum*, the causal agent of Ramorum Blight or Sudden Oak Death, is a quarantine organism. Nurseries found to be infected with *P. ramorum* face significant financial and regulatory consequences. In response to the 2004 infection of its Azusa, California nursery, Monrovia Growers developed a set of about 50 best management practices (BMP) to prevent the introduction and spread of *P. ramorum*. These practices are used at all six Monrovia Growers locations. The BMP are in addition to those practices required for maintenance of our Compliance Agreement for Nurseries Shipping Host and Associated-host Plants of *Phytophthora ramorum* Interstate as per the Federal Order Restricting Movement of Nursery Stock from California, Oregon, and Washington Nurseries, 22 Dec. 2004 <[www.aphis.usda.gov/ppq/ispmp/ramorum/](http://www.aphis.usda.gov/ppq/ispmp/ramorum/)>. Many of these BMP are similar to those listed on the California Oak Mortality Task Force web site <[www.suddenoakdeath.org](http://www.suddenoakdeath.org/)>.

### EXCLUSION

One of the most likely routes of entry into the nursery for *P. ramorum* is on infected plant material. Monrovia propagates most of its own plants, and this limits exposure to this route of entry. However, the company does bring plant materials onto its nurseries from outside vendors for new crops, crop shortages, and new plant evaluations. If these plants are host and associated plant (HAP) genera <[www.aphis.usda.gov/ppq/ispmp/ramorum/](http://www.aphis.usda.gov/ppq/ispmp/ramorum/)>, then they are tested upon arrival at the nursery and are not released to production until the tests prove negative. Inventory systems allow the tracking of these plants through the production cycle. Monrovia Growers also transfers plants between its growing locations. Host and associated plant genera are tested before they leave the source nursery and their movement through the production process at the destination nursery can be tracked through the inventory management system. Customer returns on delivery trucks are no longer accepted as these plants could become infected at the customer's nursery.

Raw materials are another potential route of pathogen entry. Bark and sawdust for growing media are sourced from outside of the current natural range of *P. ramorum*. Surface irrigation water, which is known to be a source of *Phytophthora* propagules worldwide, is disinfected prior to use.

### EARLY DETECTION

The company expends considerable effort testing plants for *Phytophthora*. As previously mentioned, plants from outside vendors and intracompany transfers are tested before they are used in production. All *P. ramorum* Host and Associated Plant (HAP) genera are tested during the time of year when the disease is most likely to be expressed, namely, during rainy periods in the fall and spring. This amounts to several thousand samples per year. Monrovia has the facilities and personnel to conduct this testing in-house. ELISA (enzyme linked immunosorbent assay) is used

to screen samples for the presence of the genus *Phytophthora*. Any ELISA-positive samples are cultured on semi-selective medium to determine if viable *Phytophthora* propagules are present. Cultures with *Phytophthora* growth are tested by nested-PCR (polymerase chain reaction) to determine if the species *P. ramorum* is present.

### **PREVENTION OF ESTABLISHMENT AND SPREAD**

Cultural practices used for *P. ramorum* prevention are common to many disease pathogens. These practices include sanitation measures such as disinfection of tools, removal of plant debris from growing beds, maintenance of beds with a clean gravel or ground cloth surface, and rouging-out of potentially infected plant material. Water management is important for water molds such as *P. ramorum*. Beds are graded to allow drainage of run off water and leaking irrigation valves are repaired to prevent areas of standing water. Host and associated plants are irrigated in the morning hours to allow the plant foliage to dry before nightfall. Microirrigation is used where practical to prevent wetting the foliage.

All crops are scouted at least once a month. Scouts are trained on disease symptoms and other basic disease information. Host and associated plants are treated with preventative fungicides. Frequency of application and material used depends on the host and time of year.

Best management practices are only useful to the extent that employees know and follow them in their daily activities. Therefore, the Monrovia BMP are incorporated into training materials used at the nursery. These training materials are step-by-step instructions for various tasks at the nursery such as pruning, potting, and shipping. New employees and existing employees transferring to another department receive this training before beginning their new responsibilities. Furthermore, refresher training is given to all employees annually.



## Bryophytes and Soil Acidification Effects on Trees: The Case of Sudden Oak Death<sup>®</sup>

Lee F. Klinger

P.O. Box 664, Big Sur, California 93920

Pathologists investigating the recent death of many oak trees in northern California have concluded that the problem is due to a new plant disease, dubbed sudden oak death (SOD), caused by the fungal pathogen *Phytophthora ramorum*. While not disputing that *P. ramorum* is involved in the final demise of many oaks, there are a growing number of experts who do not agree that this pathogen is the fundamental cause of the decline. They point out that most of the dying oaks in SOD-affected forests show no expression of *P. ramorum*. Instead, they suggest that acidic conditions create mineral imbalances and deficiencies in soils that weaken the trees, raising their susceptibility to secondary pests and pathogens. Here I present evidence that, due to fire suppression, there has been progressive acidification of oak forests, leading to greater incidence of disease. This helps us understand both why the SOD phenomenon is occurring now and what can be done to solve the problem.

The etiology of SOD in California coincides closely with the symptoms of decline seen in aging forest ecosystems elsewhere. Dieback starts with the upper and outer branches in the crown, showing a pattern of wilting and browning of leaves along with dying small branches and progressively spreading to the lower parts of the crown over several years. The decline affects many kinds of oaks, as well as bays, buckeyes, and pines, hitting mainly the larger trees in mixed-oak savannas and forests, most of which have been under strict fire control for more than 50 years. Areas near the coast and those experiencing frequent seasonal fog are especially hard hit by SOD. Affected trees tend to occur in mature forests (>100 years old) and are usually found in association with a heavy cover of mosses and lichens. Moss mats have been shown in both laboratory and field studies to be associated with the mortality of underlying fine roots and mycorrhizae, which leads to water and nutrient stress and reduced radial growth in nearby trees. Mosses and lichens are also observed to degrade the tree's protective bark layer, allowing for pests/pathogens to more easily infest/infect the tree.

Data on pH from 28,577 soil samples taken from a wide range of landscaped and agricultural soils in California indicate that only 10.2% of the soils are acidic (pH < 6.0). Data on samples taken from disease site soils (mostly with SOD) indicates that 79.2% of these soils are acidic (median pH = 5.7; n = 136). Soils from the disease sites were also found to be consistently low in Ca and very high in soluble Al and Fe. Spatial analysis reveals a strong coastal gradient in soil pH with the lowest pH values found near the coast. Strong coastal gradients are also apparent in soil Ca, which is lowest near the coast, and in soil Al, which is highest near the coast.

These results lend further support to the theory that systemic acidification is adversely affecting the health of the trees and soils, predisposing trees to infection by the SOD pathogen. It is recommended, thus, that the scope of SOD research be expanded to include studies of acidification by mosses and lichens in the context of forest and soil ecology.

## INTRODUCTION

Sudden Oak Death (SOD), defined by the California Oak Mortality Task Force (COMTF) scientists as the decline and death of trees caused by the fungal pathogen *Phytophthora ramorum*, is widespread across the coastal forests of northern California. The pathogen has now been found in numerous species of California plants and in certain nursery plants around the U.S.A. While the current research is focused on the genetics, transmission, and epidemiology of the *P. ramorum* pathogen, information on the ecology related to SOD is sorely lacking. From an ecosystem perspective the partial or complete death of a tree indicates not only a dysfunction or disease affecting that organism, it signifies, as well, a change or shift in the composition and metabolism of the whole forest ecosystem (Klinger, 1991). In the case of SOD, such an approach seems especially pertinent given the fact that most of the trees dying in SOD-affected forests show no visible expression of the *P. ramorum* pathogen. The presence of secondary pests like Ambrosia beetles in SOD-affected forests raises the possibility that *P. ramorum*, too, may be secondary, that there are other agents acting to weaken the trees and increase their susceptibility to fungal attack. Clearly, any credible information that implicates factors other than *P. ramorum* in SOD must be carefully investigated. This paper describes the theory of systemic acidification and investigates the regional patterns of soils and precipitation chemistry from California as related to the role of bryophytes and systemic acidification in the decline of oaks in California.

## FOREST DECLINE AND SYSTEMIC ACIDIFICATION

In studies of ecosystem change, ecologists have frequently reported how maturing landscapes progress through a series of characteristic communities, stages of development much like those of individual organisms. Successional (i.e., developmental) studies of forested landscapes have shown that as forests mature and age the vegetation takes on more evergreen forms, mosses and lichens increase in abundance, and surface soils become more acidic. This process of systemic acidification is due, in part, to the buildup of biomass (mainly plant organic matter), which, upon microbial decomposition, releases organic acids that acidify and leach mineral nutrients from the soils. Older forests that escape burning or otherwise go undisturbed for several generations will eventually show symptoms of decline such as top dieback, reduced rates of radial growth, and fine-root mortality (Huettl and Mueller-Dombois, 1993).

In the early 1970s scientists in the U.S.A. and Europe started to pay attention to observations of rapid dieback in certain forests that previously appeared healthy. As these forests were often within a few hundred kilometers of highly industrialized regions, air pollution and acid rain were implicated as probable culprits. But upon completion of the major research programs, forest scientists concluded that acid rain and air pollution were not the primary causes of forest decline. The reasons for this are obvious. Forest decline with symptomology identical to that found in polluted regions occurs extensively in unpolluted areas such as Alaska (Klinger, 1988), Hawaii (Mueller-Dombois, 1987), New Zealand (Wardle and Allen, 1983), and the southern Andes (Veblen and Lorenz, 1987). This pattern suggests the involvement of natural processes in tree death, which are somehow exacerbated by pollution.

Many scientists now see forest decline as a global phenomenon that has been occurring sporadically for thousands of years (Mueller-Dombois, 1987, 1988). "De-

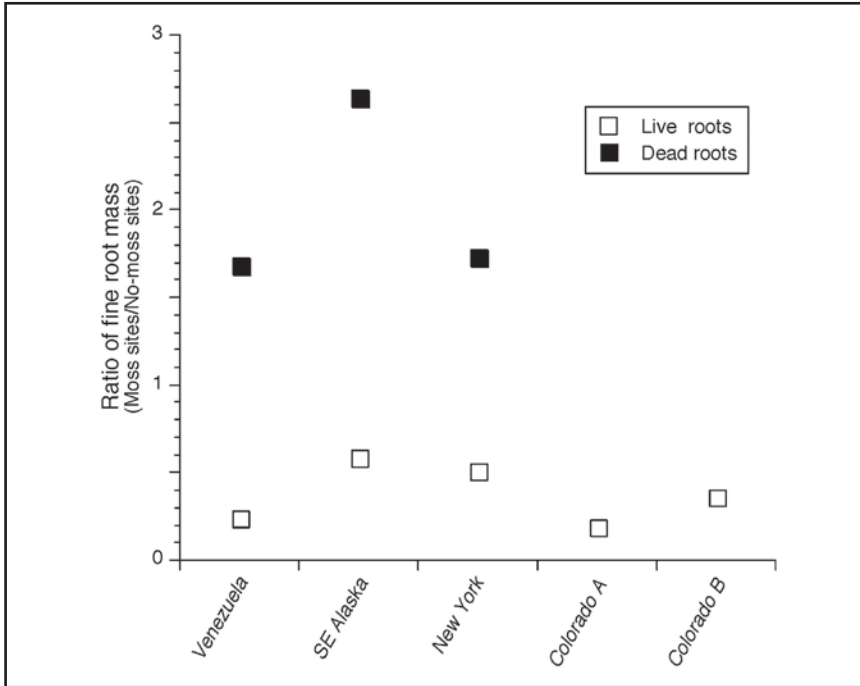
cline” and “dieback” are terms used synonymously to describe forests where the majority of trees show reduced vigor or are standing dead. In some forests the obvious causal mechanisms of fire, wind, or flooding can explain the death of trees. However, in many areas forest dieback cannot be explained by these or other mechanisms. Insects, fungal pathogens, mistletoe, or other forest pests are often, but not always, present in declining forests. Forest decline tends to occur in moist-to-wet sites, though not always, and there is growing evidence that tree death can be drought-induced. In some areas tree death occurs in groups, but more often mortality is scattered throughout an affected forest in a seemingly random pattern. Forest decline affects mainly mature or old-growth forests and tends to affect canopy trees more severely than subcanopy trees. Yet, growing within heavily damaged forests are some canopy trees, which are barely, if at all, affected. Seedling and sapling growth in damaged areas appears to be inhibited in many but not all situations.

With regards to the etiology of global forest decline, scientists note that affected trees tend to exhibit dieback beginning at the top or outermost branches and progressing downward or inward (Mueller-Dombois, 1987). Decreased diameter growth is commonly associated with forest decline, as are symptoms of nutrient deficiencies and water stress (Ash, 1988; Hinrichsen, 1987; Schütt and Cowling, 1985). In studies where belowground plant tissue has been examined, mortality of very fine (feeder) roots and mycorrhizae has also been documented (Hinrichsen, 1987; Jane and Green, 1987; Klein, 1984; Schütt and Cowling, 1985). Of particular importance is the observation that feeder root and mycorrhizae mortality occurs prior to the onset of aboveground dieback symptoms (Klein, 1984; Manion, 1981). The decline is often, though not always, accompanied by attacks of pathogenic fungi and/or insects. Surface soils in declining forests are typically found to be acidic (Klinger, 1990), depleted in base cations (Huntington, 2000), and enriched in soluble Fe and Al (Klinger, 1996).

### THE ROLE OF BRYOPHYTES

Field studies focusing on the role of mosses in forest decline have reported a significant relationship between the presence of ground-dwelling mosses and the mortality of fine (feeder) roots and mycorrhizae in the soils beneath declining forests of southeast Alaska, New York, Colorado, and Venezuela (Cornish, 1999; Klinger, 1990; Smith and Klinger, 1985). Together these studies have documented highly significant decreases in the radial growth of trees and highly significant increases in the acidity of soils with an increase in moss cover (Fig. 1). Fine root mortality is reported elsewhere to be closely tied to soil acidification, especially where calcium levels are low (Matzner et al., 1986; Schaberg et al., 2001).

Soluble Al concentrations are reported to be high in the organic soil horizons and in the soil water beneath declining trees (Joslin et al., 1988). The fine roots of declining trees are found to contain significantly more Al than those of healthy trees (McLaughlin et al., 1987). Controlled laboratory experiments show a significant inverse correlation between soil Al and the live root biomass in oaks (Joslin and Wolfe, 1989). Strong acidification and high concentrations of soluble Al in soil water are reported to inhibit the growth of endomycorrhizal fungi (Ouimet et al., 1995). Acidic soil conditions are reported in declining oak forests in the eastern U.S.A. (Demchik and Sharpe, 2000) and in Europe (Thomas et al., 2002).



**Figure 1.** Ratios of fine root mass, compiled from Cornish (1999), Klingler (1990), Smith and Klingler (1985), and Klingler (unpublished data). Expected ratio if mosses have no effect on roots is around "1."

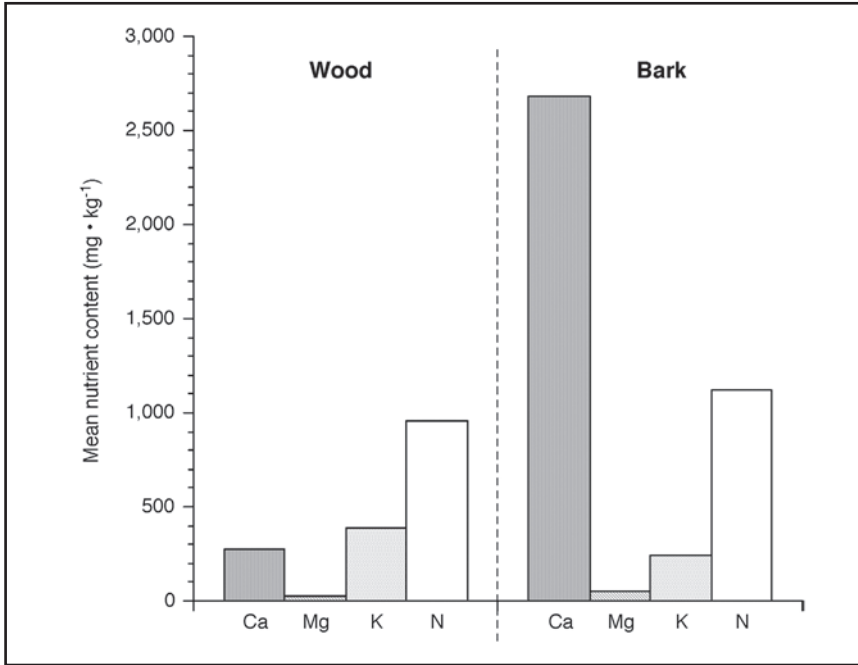
In all, the evidence indicates that acids from precipitation and those released by humus, mosses, and lichens leach the surface soils of base cations and mobilize heavy metals (especially Al) to toxic levels, thus killing the fine roots and mycorrhizal fungi, interfering with the Ca and Mg uptake and transport, and slowing the cambial growth of trees (Alva et al., 2002; Cornish, 1999; Klingler, 1988; Shortle and Smith, 1988).

With the heavy Ca requirements of trees for maintaining healthy wood and bark (see Fig. 2), Ca and related mineral deficiencies rank high on the list of concerns of many scientists studying forest decline.

The acids produced by mosses and lichens are notorious for their ability to accelerate the weathering of substrates, including bark and rock. This raises the distinct possibility that the thick buildup of mosses and lichens on the trunks and branches of SOD-infected trees is degrading the protective bark layer and creating points of entry for *P. ramorum* and other pathogens into the stem. This buildup of mosses and lichens does not tend to occur in oaks managed with prescribed fires.

### THE ROLE OF FUNGAL PATHOGENS

While *P. ramorum* ranges across the coastal forests of Northern California, its expression follows a general pattern whereby cankers occur mainly at the base of the older canopy trees in mixed-oak forests in moist valleys and on hillsides, especially where fog is frequent. The incidence of SOD is highest near the coast and declines



**Figure 2.** Summary of tissue assay for nine English Oaks (*Quercus robur*) (compiled from Bosman et al. 2001).

significantly with increasing distance from the coast (Murphy and Rizzo, 2005). Affected trees tend to occur in forests greater than 100 years old and with a heavy cover of mosses. The entire region has been under strict fire control for more than 50 years. A coastal to inland gradient of increasing precipitation pH, which has been observed elsewhere along the north Pacific coast (Klinger and Erickson, 1997), is also apparent here in northern California (McColl, 1980). The decline patterns and environment of this region are comparable to those of other forests around the world affected by decline (Huettl and Mueller-Dombois, 1993).

Both *Phytophthora* and *Pythium* pathogens have been observed to play a role in the decline of trees in Europe (Nechwatal and Oswald, 2001). These and other fungal pathogens attack the roots and cambium of certain trees and clearly contribute to the demise of these trees. Fungal pathogens are commonly associated with acidic environments and could well be opportunists preying upon trees weakened by mineral and water deficiencies. The addition of alkaline-rich minerals is well known to have a mitigating effect on the pathogenicity of *Phytophthora* species (Jung et al., 2000; Shea and Broadbent, 1983). Researchers have recently confirmed the fire-disease relationship for SOD, finding that the incidence of *P. ramorum* is extremely rare within the perimeter of any area burned since 1950 (Moritz and Odion, 2005).

Michael Coffey, Curator of the World *Phytophthora* Collection at the University of California, Riverside, believes that the concept of new *Phytophthora* species could be misleading since likely many, if not all, have been in place for decades, some perhaps for thousands of years. He suggests that the recent ability to use molecular

**Table 1.** Summary statistics of the chemical constituents in soil samples from sites of unhealthy trees in California.

Variable	Mean	Median	Std Dev	Units	N
Al	24.3	5.3	41.7	(ppm)	70
B	0.6	0.4	0.4	(ppm)	119
Ca	1389.0	1201.5	758.7	(ppm)	136
CEC	14.4	12.4	6.6	(meq/100g)	120
Cu	1.6	1.2	1.7	(ppm)	123
Fe	75.4	68.5	78.6	(ppm)	123
K	207.1	180.6	125.0	(ppm)	124
Mg	451.9	363.6	321.9	(ppm)	124
Mn	14.8	11.5	12.9	(ppm)	123
Na	56.3	34.7	86.3	(ppm)	124
NO <sub>3</sub> -N	11.0	5.7	21.2	(ppm)	120
Org. Matter	4.8	4.2	3.4	(%)	120
P	28.4	13.5	34.0	(ppm)	132
pH	5.8	5.7	0.6		136
SO <sub>4</sub> -S	21.6	7.0	66.8	(ppm)	117
Sol. Salts	0.6	0.4	0.9	(mmhos/cm)	117
Zn	6.5	2.7	9.4	(ppm)	123

methods to rapidly and accurately identify microbes such as *Phytophthora* has created the illusion that these pathogens are recently introduced and on the increase. In the case of SOD the extremely close similarity with a root pathogen *P. lateralis*, which has been recorded in the Pacific region forests since 1920, suggests the possibility that *P. ramorum* has been in the region for many decades. <[http://www.geocities.com/m\\_d\\_coffey/sodoff2.html](http://www.geocities.com/m_d_coffey/sodoff2.html)>

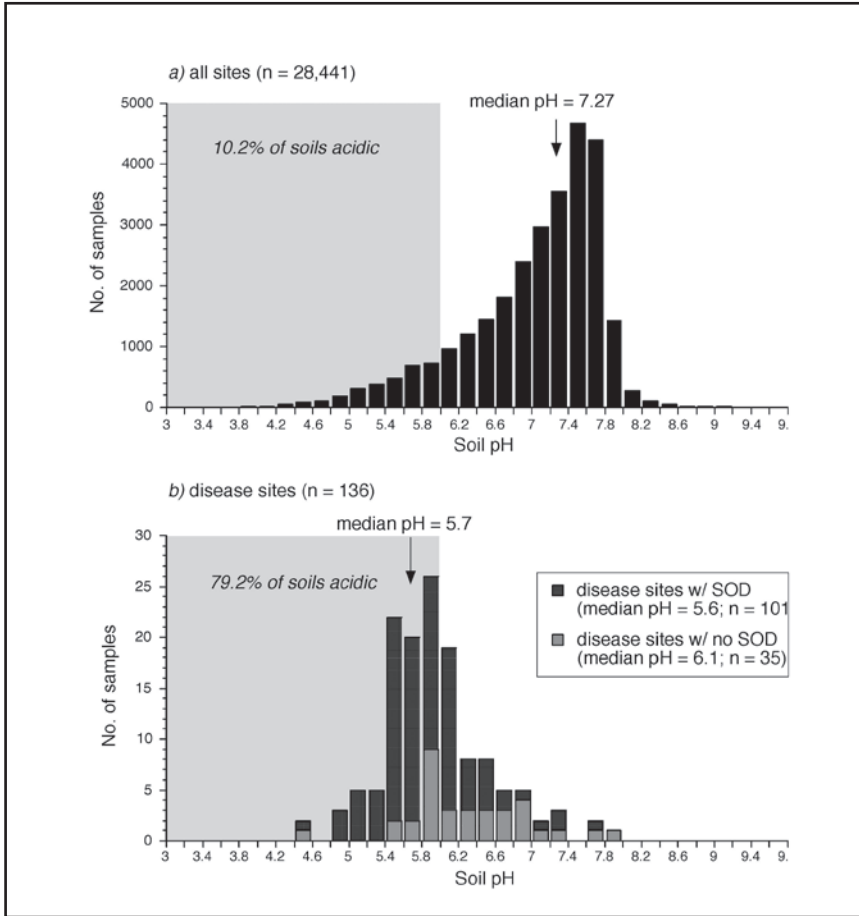
### SOIL REMINERALIZATION

Not surprisingly, success in treating forest decline has been widely achieved using methods such as liming and burning, which ameliorate soil acidity and cryptogam cover. Burning and liming produce similar results as they both reduce the sources of acidity and raise the base cation concentration in the surface soils (Schreffler and W.E. Sharpe, 2003).

The traditional practice of applying limewash to the trunks of trees (i.e., whitewashing) has long been known to improve tree health. Limewashing is still a common practice in many traditional forest cultures around the world (e.g., in Mexico, China, and India). The large volume of studies on lime treatments of declining forests together indicate that the addition of lime-rich minerals clearly improves the health of trees (Wilmot et al., 1996), improves root and mycorrhizae growth (Coughlan, 2000), improves soil fertility (Hindar et al., 1996), reduces levels of toxic metals in soils (Alva et al., 1993), and reduces moss cover (Hallbacken and Zhang, 1998). In short, the application of lime-rich minerals appears to revitalize declining forest ecosystems.

### OBSERVATIONS IN CALIFORNIA

Over the past few years soil samples and observations at sites with diseased trees (mainly SOD-infected oaks) provide some evidence that systemic acidification is occurring in California. Between February 2000 and December 2004, 136 surface soil samples were collected near unhealthy trees from a range of locations in California.



**Figure 3.** Frequency distributions of soil pH data from a) non-diseased sites (R. Miller, unpublished data) and b) diseased sites (this study) in landscaped and agricultural areas of California. SOD = sudden oak death.

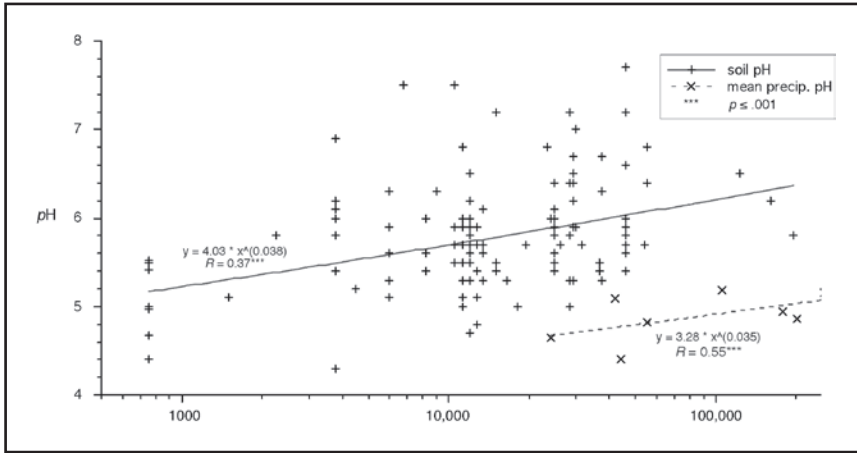
Chemical analyses were performed on each soil sample by A & L Western Agricultural Laboratories (Modesto, California) (Klinger and Zingaro, 2005).

Table 1 lists the mean, median, standard deviation, and sample size for 17 soil chemistry variables. These results suggest that soils near SOD-affected trees are low in pH (median = 5.8) and Ca (median = 1201.5 ppm) and high in soluble Al (24.3 ppm) and Fe (75.4 ppm). Also, of the soils analyzed for lime content, nearly all (116 out of 120) were found to be low in excess lime.

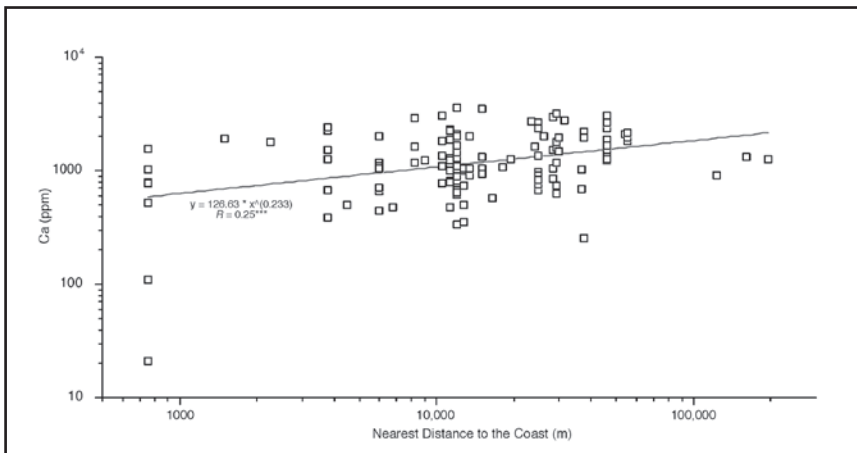
Figure 3 shows the frequency distributions of soil pH, comparing the above data with a larger data set of soil pH from landscaped and cultivated soils in California. This figure indicates that soil pH is significantly lower in disease sites (median pH = 5.7) compared to the broader suite of other sites in California (median pH = 7.27).

Soil pH values as a function of nearest distance to the coast is plotted in Figure 4. For comparison, precipitation pH values from northern California are also





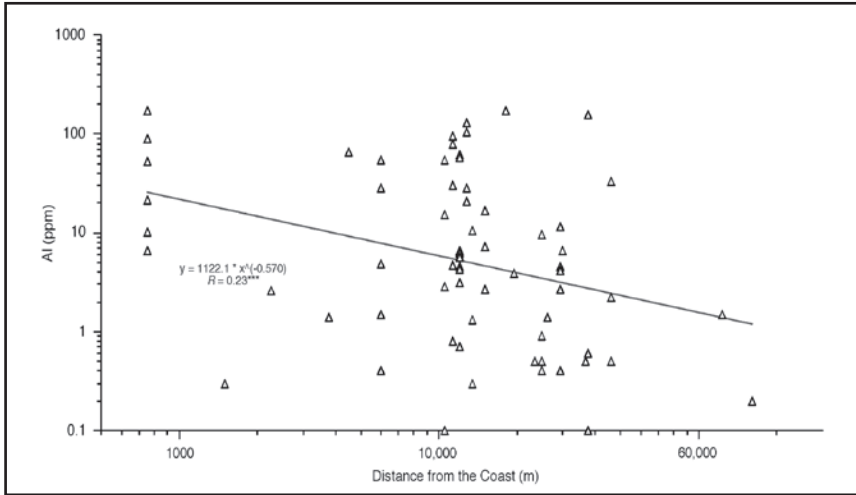
**Figure 4.** pH of soils (this study) and mean pH of precipitation (McColl 1980) as a log function of nearest distance to the coast in the sudden oak death-affected region of California. Best-fit lines of the data are power law functions (see equations).  $R$  is the regression coefficient; probability ( $p$ )  $\leq .001$  (\*\*\*)



**Figure 5.** Calcium content of soils in this study as a log-log function of nearest distance to the coast in the sudden oak death-affected regions of California. Best-fit line of the data is a power law function (see equation).  $R$  is the regression coefficient; probability ( $p$ )  $\leq .001$  (\*\*\*)

shown. These values were obtained from the NADP California region data sets <<http://nadp.sws.uiuc.edu/>> and from McColl (1980). The soil data reveal a strong coastal pH gradient, with the lowest pH levels found nearest the coast. Strong coastal gradients are also apparent in Ca (Fig. 5), which is lowest near the coast, and in Al (Fig. 6), which is highest near the coast.

As an interesting aside, these and other variables in this data set exhibit gradients that are best fit by power law functions (best fit equations are given in the figures). Power law functions are commonly used to describe systems that are frac-



**Figure 6.** Aluminum content of soils in this study as a log-log function of nearest distance to the coast in the sudden oak death-affected region of California. Best-fit line of the data is a power law function (see equation).  $R$  is the regression coefficient; probability ( $p$ )  $\leq .001$  (\*\*\*) .

tal, or self-similar, and are indicative of criticality in complex systems (Bak, 1996). The implication here is that the ecological and atmospheric systems in this region are behaving according to the principles of systems theory, which is the conceptual basis for systemic acidification in forest ecosystems (Klinger, 2004).

Finally, observations of declining trees in California (including many SOD-infected oaks) before and after being treated with mineral nutrient amendments to the soil and bark are showing vigorous new growth (see <http://www.suddenoaklife.org/>). These findings are only a few years along, but the consistency and quickness in the response of the trees to the lime-rich minerals is strongly indicative of a systemic acidification problem in these forests. Furthermore, recent findings suggest that the Native Americans in California knew about the role of acidification in tree decline and the importance of mineral amendments in sustaining older trees. Besides managing the forests with fires (Anderson, 2005), evidence indicates that they crushed seashells, bones, and other mineral-rich materials and then spread them to amend the soils around oaks and other important trees (Klinger, 2006).

## CONCLUSIONS

The geographic and temporal patterns in soils and rainfall chemistry reported here for the SOD-affected regions of California are consistent with those that would be expected if the decline is associated with systemic acidification. These findings are similar to those found in southeast Alaska where forest decline has been incorrectly attributed to a fungal pathogen (Klinger, 1988).

Given these results and considering, as well, other evidence that systemic acidification is associated with forest decline in California, I conclude that an expanded definition of and approach to SOD is warranted.

**Acknowledgements.** The author would like to thank all those who have helped in the development of this work, and to acknowledge M. Coffey, Q.-J. Li, M. Cornish, L. Herrli, R. Zingaro, and R. Miller for sharing their related findings.

## LITERATURE CITED

- Alva, A.K., J.H. Graham, and D.P.H. Tucker.** 1993. Role of calcium in amelioration of copper phytotoxicity for citrus. *Soil Sci.* 155:211-218.
- Alva, A.K., B. Huang, S. Paramasivam, and K.S. Sajwan.** 2002. Evaluation of root growth limiting factors in spodic horizons of spodosols. *J. Plant Nutr.* 25:2001-2014.
- Anderson, M.K.** 2005. *Tending the wild.* Univ. California Press, Berkeley, California.
- Ash, J.** 1988. *Nothofagus* (Fagaceae) forest on Mt. Giluwe, New Guinea. *New Zealand J. Bot.* 26:245-258.
- Bak, P.** 1996. *How nature works.* Springer-Verlag, New York, New York.
- Bosman, B., J. Remacle, and M. Carno.** 2001. Element removal in harvested tree biomass: Scenarios for critical loads in Wallonia, South Belgium. *Water, Air, Soil Poll. Focus* 1:153-167.
- Cornish, M.** 1999. Forest decline as a successional process: the role of bryophytes in a montane ecosystem in the Colorado Rocky Mountains. M.Sc. Dissertation, The University of Oxford, Oxford.
- Coughlan, A.P., Y. Dalpe, L. Lapointe, and Y. Piche.** 2000. Soil pH-induced changes in root colonization, diversity, and reproduction of symbiotic arbuscular mycorrhizal fungi from healthy and declining sugar maple forests. *Can. J. For. Res.* 30:1543-1554.
- Demchik, M.C. and W.E. Sharpe.** 2000. The effect of soil nutrition, soil acidity and drought on northern red oak (*Quercus rubra* L.) growth and nutrition on Pennsylvania sites with high and low red oak mortality. *For. Ecol. Mgt.* 136:199-207.
- Hallbacken, L. and L.Q. Zhang.** 1998. Effects of experimental acidification, nitrogen addition and liming on ground vegetation in a mature stand of Norway spruce (*Picea abies* (L.) Karst.) in SE Sweden. *For. Ecol. Mgt.* 108:201-213.
- Hindar, A., F. Kroglund, E. Lydersen, A. Skiple and R. Hogberget.** 1996. Liming of wetlands in the acidified Lake Roynelandsvatn catchment in southern Norway: effects on stream water chemistry. *Can. J. Fisheries Aquatic Sci.* 53:985-993.
- Hinrichsen, D.** 1987. The forest decline enigma. *BioSci.* 37:542-546.
- Huettl, R.F. and D. Mueller-Dombois** (eds.) 1993. *Forest Decline in the Atlantic and Pacific Regions.* Springer-Verlag, Berlin.
- Huntington, T.G.** 2000. The potential for calcium depletion in forest ecosystems of south-eastern United States: Review and analysis. *Global Biogeochem. Cycles* 14:623-638.
- Jane, G.T. and T.G.A. Green.** 1987. Etiology of forest dieback areas within the Katmai Range, North Island, New Zealand. *New Zealand J. Bot.* 24:513-527.
- Joslin, J.D., J. M. Kelly, M.W. Wolfe, and L.E. Rustad.** 1988. Elemental patterns in roots and foliage of mature spruce across a gradient of soil aluminum. *Water, Air Soil Poll.* 40:375-390.
- Joslin, J.D. and M.H. Wolfe.** 1989. Aluminum effects on northern red oak seedling growth in six forest soil horizons. *Soil Sci. Soc. Amer. J.* 53:274-281.
- Jung, T., H. Blaschke, and W. Oswald.** 2000. Involvement of soilborne *Phytophthora* species in Central European oak decline and the effect of site factors on the disease. *Plant Pathol.* 49:706-718.
- Klein, R.M.** 1984. Effect of acidity and metal ions on water movement through red spruce, p. 303-322. In: D.D. Adams and W.P. Page (eds.) *Acid deposition.* Plenum Press, New York, New York.
- Klinger, L.F.** 1988. Successional change in vegetation and soils of southeast Alaska. Doctoral dissertation, Department of Geography, University of Colorado, Boulder, Colorado.
- Klinger, L.F.** 1990. Global patterns in community succession. 1. Bryophytes and forest decline. *Memoirs of the Torrey Botanical Club* 24:1-50.
- Klinger, L.F.** 1991. Peatland formation and ice ages: a possible Gaian mechanism related to community succession, p. 246-255. In: S.H. Schneider and P.J. Boston (eds.) *Scientists on Gaia,* The MIT Press, Cambridge, Massachusetts.

- Klinger, L.F.** 1996. Coupling of soils and vegetation in peatland succession. *Arctic Alpine Res.* 28:380–387.
- Klinger, L.F.** and **D.J. Erickson III.** 1997. Geophysiological coupling of marine and terrestrial ecosystems. *J. Geophys. Res.-Atmos.* 102:25,359–25,370.
- Klinger, L.F.** 2004. Gaia and complexity, p.187–200. In S.H. Schneider, J.R. Miller, E. Crist, and P.J. Boston (eds.), *Scientists Debate Gaia: The Next Century*. The MIT Press, Cambridge, MA.
- Klinger, L.,** and **R. Zingaro.** 2005. Etiology and evidence of systemic acidification in SOD-affected forests of California. *Sudden Oak Death Science Symposium II*, 18–21 Jan. 2005, Monterey, California.
- Klinger, L.F.** 2006. Ecological evidence of large-scale silviculture by California Indians. In: Wahinkpe Topa (Four Arrows) (ed.), *Unlearning the language of conquest*. Univ. Texas Press, Austin, TX (in press).
- Manion, P.D.** 1981. *Tree disease concepts*. Prentice Hall, Inglewood Cliffs, New Jersey.
- Matzner, E., D. Murach,** and **H. Fortmann.** 1986. Soil acidity and its relationship to root growth in declining forest stands in Germany. *Water Air Soil Poll.* 31:273–282.
- McCull, J.G.** 1980. A survey of acid precipitation in Northern California. *Final Rept. Agric. Exper. Station, Univ. California, Berkeley, California.*
- McLaughlin, D.L., S.N. Linzon, D.E. Dimma,** and **W.D. McIlveen.** 1987. Sugar maple decline in Ontario, p. 101–116. In: T.C. Hutchinson & K.M. Meema (eds.), *Effects of atmospheric pollutants on forests. Wetlands and Agricultural Ecosystems*. Springer-Verlag, Berlin.
- Moritz, M.A.** and **D.C. Odion.** 2005. Examining the strength and possible causes of the relationship between fire history and sudden oak death. *Oecologia DOI* 10.1007/s00442-005-0028-1.
- Mueller-Dombois, D.** 1987. Natural dieback in forests. *BioSci.* 37:575–583.
- Mueller-Dombois, D.** 1988. Forest decline and dieback — A global ecological problem. *TREE* 3:310–312.
- Murphy, S.** and **D. Rizzo.** 2005. Incidence of *Phytophthora ramorum*, *P. nemorosa*, and *P. pseudosyringae* in three coastal California forest communities. *Sudden Oak Death Science Symposium II*, 18–21 Jan. 2005, Monterey, California.
- Nechwatal, J.** and **W. Oswald.** 2001. Comparative studies on the fine root status of healthy and declining spruce and beech trees in the Bavarian Alps and occurrence of *Phytophthora* and *Pythium* species. *For. Pathol.* 31:257–273.
- Ouimet, R., C. Camire,** and **V. Furlan.** 1995. Endomycorrhizal status of sugar maple in relation to tree decline and foliar, fine-roots, and soil chemistry in the Beauce region, Quebec. *Can. J. Bot.* 73:1168–1175.
- Schütt, P.** and **E. Cowling.** 1985. Waldsterben, a general decline of forests in central Europe: Symptoms, development, and possible causes. *Plant Dis.* 69:548–558.
- Schaberg, P.G., D.H. DeHayes,** and **G.J. Hawley.** 2001. Anthropogenic calcium depletion: A unique threat to forest ecosystem health? *Ecosystem Health* 7:214–228.
- Schreffler, A.M.** and **W.E. Sharpe.** 2003. Effects of lime, fertilizer, and herbicide on forest soil and soil solution chemistry, hardwood regeneration, and hardwood growth following shelterwood harvest. *For. Ecol. Mgt.* 177:471–484.
- Shea, S.R.** and **G.C.P. Broadbent.** 1983. Developments in cultural and biological control of *Phytophthora* diseases, p.335–350. In: Erwin, Bartnicki-Garcia, and Tsao (eds.), *Phytophthora: Its biology, taxonomy, ecology and pathology*. APS Press, Saint Paul, Minnesota.
- Shortle, W.C.** and **K.T. Smith.** 1988. Aluminum-induced calcium deficiency syndrome in declining red spruce. *Science* 240:1017–10118.
- Smith, J.M.B.** and **L.F. Klinger.** 1985. Aboveground-belowground phytomass ratios in Venezuelan Paramo vegetation and their significance. *Arctic Alpine Res.* 17:189–198.
- Thomas, F.M., R. Blank,** and **G. Hartmann.** 2002. Abiotic and biotic factors and their interactions as causes of oak decline in Central Europe. *For. Pathol.* 32:277.
- Wardle, J.A.** and **R.B. Allen.** 1983. Dieback in New Zealand *Nothofagus* forests. *Pac. Sci.* 37:397–404.
- Wilmot, T.R., D.S. Ellsworth,** and **M.T. Tyree.** 1996. Base cation fertilization and liming effects on nutrition and growth of Vermont sugar maple stands. *For. Ecol. and Mgt.* 84:123–134.

## Selecting the Right Herbicide for Nursery and Landscape Use<sup>®</sup>

**Robert P. Rice Jr.**

Department of Horticulture and Crop Science, California Polytechnical University, San Luis Obispo, California 93407

For many weed control practitioners in the nursery and landscape industries, chemical weed control means the use of a common pre-emergent herbicide such as Ronstar and a post-emergent treatment with Roundup. The relative safety, effectiveness, and low cost of chemical weed control when compared with hand weeding limits their consideration of other options.

Actually, a more careful look at herbicide choices can reap benefits in lowering weed control costs, possibly improving quality of control, and decreasing environmental and safety concerns. For each application situation a different herbicide or herbicide combination may perform better, and the extra effort in evaluating the situation will pay for itself. The first step is to determine the weed spectrum that will need to be controlled as well as the mix of ornamental species that might be present in the treated areas. References such as *The Nursery and Landscape Weed Control Manual* (Rice, 2001) and the *Turf and Ornamental Reference for Plant Protection Products* (Anonymous, 2003) provide cross references that will facilitate the process of determining which herbicides will control all or the majority of the weeds while being safe to use on desirable ornamentals.

### **ECONOMICS**

There are a number of factors that should be considered as a part of the process of evaluating the cost of weed control:

- Cost of product/unit area—i.e., \$100/acre.
- Duration of effective weed control (how long will the product effectively control weeds and how long do you need weed control?).
- Are there formulation options with differing costs (granular vs. wettable powder, for example)?
- Weed spectrum controlled (will the product control all the weeds or will escapes have to be controlled by hand or post-emergence applications?).
- Consider a tank mix to pick up uncontrolled species rather than increasing the rate of one herbicide to control difficult species (often the combination of two herbicides at low rates will provide better and more cost-effective control than using one herbicide at a higher rate).
- Incorporation flexibility (how long can you wait after application before incorporating the herbicide?).
- Will an older, out-of-patent material work as well as a higher priced patented material?
- Risk of hidden phytotoxicity (i.e., dwarfing, slowing of growth, poor rooting of stolons).
- Risk of drift injury to surrounding plants (translocated vs. contact post-emergent materials).

- Risk of injury due to adverse weather (i.e., leaching of positionally selective herbicides).
- Risk of obvious phytotoxicity.

### ENVIRONMENTAL SAVINGS

When contemplating the environmental concerns associated with herbicide treatments, thought should be given to factors such as:

Long-term cost of the herbicide as it relates to environmental problems:

- Leaching, runoff, nonpoint source pollution, recycling of water in nurseries.
- Volatilization, photodegradation.
- Pre-emergence vs. repeated post-emergence.
- Resistance and herbicide rotation.

Remember that herbicides are only one tool in your weed control toolbox and should be used as a part of an integrated weed control program that includes the use of mulches, competition and proper ornamental plant choice and density, preventive practices such as equipment cleaning and prevention of seed production, solarization, and steam sterilization of nursery soils among others. Ultimately, proper herbicide choice coupled with an integrated approach to weed management will result in maximum economic and environmental savings.

### LITERATURE CITED

- Anonymous.** 2003. Turf and ornamental reference for plant protection products. C&P Press, New York.
- Rice, R.P.** 2001. Nursery and landscape weed control manual. Thomson Publications, Fresno, California.

## General Session IV: Question and Answer Session

**Kristin Yanker-Hansen:** Have you done any work with tropical forests?

**Lee Klinger:** Actually, the same holds for tropical forests. In the tropics you actually shift from early successional deciduous and semi-deciduous to evergreen trees. The evergreen trees in the tropics tend to be broad-leaved evergreens as opposed to the needle-leaved evergreen in the temperate zones, but you still have that shift.

**Mary Helen Seeger:** Is the fertilization regime you're suggesting similar to what Ralph Navarro is doing?

**Lee Klinger:** Yes it is, although Ralph is promoting more of phosphate fertilization. My emphasis is on not using any of the phosphate products; I'm just using calcium-rich minerals. Also, he's not promoting the lime wash, which I'm finding to be very effective in getting a very fast response, especially with cracked trees. The lime minerals quickly get into the tree.

**Mary Helen Seeger:** Just one more comment on that. With other types of *Phytophthora* that's been a recommended procedure for backyard use.

**Ellen Zagory:** Does an increase in pH kill *Phytophthora ramorum*?

**Lee Klinger:** So far I've not been able to get funding to answer that question.

**John Keller:** There is some information known on other species of *Phytophthora* that are sometimes suppressed in extremely acidic soils that probably wouldn't be seen in nature, but in some nursery soils the root-attacking phytophthoras are sometimes suppressed by low pH.

**Germaine Boivin:** What are the chances that *Phytophthora ramorum* could show up in the central valley in northern California?

**John Keller:** There was one nursery in 2003 in the central valley on the north end of the San Joaquin Valley where it was found, and even in hot areas, the pathogen can show up in cool, moist shade houses.

**Kristin Yanker-Hansen:** Are your seeds available to us today?

**Paul Rys:** Yes, they are. I believe as all plant propagators in the theory of abundance. Seeds don't grow in envelopes. I pass out my seeds to people all over the world.

**Kristin Yanker-Hansen:** How do you irrigate your plants?

**Paul Rys:** There are several methods for watering. We set up misting systems, and during the heat of the day, we will use automatic misters that will overhead spray for 1–2 min. every 20 min. Misting helps avoid any water stress that will slow or stop vegetative growth.

**Kristin Yanker-Hansen:** Do you think it matters how much water you put to the roots of these pumpkins?

**Paul Rys:** We don't apply too much water, but they need to be moist for best growth.

**Dave Herbert:** Are you suggesting that a whitewash treatment will improve or promote healing in cracked bark?



**Lee Klinger:** Yes, I am. It's actually through the nutritional value of the lime wash. I need to point out that I'm treating more than 70 varieties of trees now and having good success.

**Greg McPhee:** What is your nutritional program for your pumpkins? Are you using growth promoters?

**Paul Rys:** I only add organic matter from horse manure and shavings, and the reason why I'm doing that is other growers add all kinds of chemicals to get them to grow really big. I'm trying to grow them in a controlled environment. If I see a pumpkin plant that is vigorous with no additives, then I know it's going to have the potential for being bigger later.

---

## Notes on Propagation of Various Tropical Woody Ornamentals®

**Richard A. Criley**

Department of Tropical Plant & Soil Sciences, University of Hawaii, Honolulu, Hawaii 96822

**Auxin series, ranging from 0 to 7500 ppm, were evaluated on eight tropical woody ornamental materials as laboratory exercises for a class in plant propagation. The auxins were either indole-3-butyric acid (IBA) used alone or the commercial preparation Dip 'N Grow® (1% IBA and 0.5% NAA). Terminal cuttings were taken in late fall, rooted under intermittent mist during low light winter conditions, and evaluated 6 to 8 weeks later in most cases. Rooting percentages and a rooting index based on root mass were determined. Optimum auxin concentrations were: 1000 ppm for *Acalypha wilkesiana* (dwarf copper-leaf), 6250 ppm for *Aglaia odorata*, 500 ppm for *Duranta erecta* 'Alba', 6000 ppm for *Galphimia gracilis*, 1500 ppm for *Ilex vomitoria* 'Stoke's Dwarf', 6000 ppm for a *Rhododendron aurigeranum* × *R. herzogii* hybrid, 2500 ppm for *Thunbergia erecta*, and 1200 to 2250 for *Gardenia brighamii*.**

### INTRODUCTION

"Propagated by cuttings" is the usual notation for propagation information in many of the books that describe tropical ornamental plants (Chin, 2003; Rauch and Weisich, 2000; Sparrow and Hanly, 2002; Staples and Herbst, 2005; Whistler, 2000). Such information is not specific enough, especially for plants that are difficult to propagate by cuttings. The information provided in this paper was extracted from a series of plant propagation experiments set up for a plant propagation class at the University of Hawaii over several years. The objective was to inform students about how to take data and determine the best concentration in an auxin series for the propagation of a particular plant. Students had to prepare a write-up of the exercise as practice for future laboratory experiments.

### MATERIALS AND METHODS

The plant materials were: *Acalypha wilkesiana* (dwarf copper-leaf), *Aglaia odorata* (Chinese rice flower), *Duranta erecta* 'Alba' (golden dewdrop), *Galphimia gracilis* (thryallis), *Gardenia brighamii* (nanu, a native Hawaiian gardenia), *Ilex vomitoria*

**Lee Klinger:** Yes, I am. It's actually through the nutritional value of the lime wash. I need to point out that I'm treating more than 70 varieties of trees now and having good success.

**Greg McPhee:** What is your nutritional program for your pumpkins? Are you using growth promoters?

**Paul Rys:** I only add organic matter from horse manure and shavings, and the reason why I'm doing that is other growers add all kinds of chemicals to get them to grow really big. I'm trying to grow them in a controlled environment. If I see a pumpkin plant that is vigorous with no additives, then I know it's going to have the potential for being bigger later.

---

## Notes on Propagation of Various Tropical Woody Ornamentals®

**Richard A. Criley**

Department of Tropical Plant & Soil Sciences, University of Hawaii, Honolulu, Hawaii 96822

**Auxin series, ranging from 0 to 7500 ppm, were evaluated on eight tropical woody ornamental materials as laboratory exercises for a class in plant propagation. The auxins were either indole-3-butyric acid (IBA) used alone or the commercial preparation Dip 'N Grow® (1% IBA and 0.5% NAA). Terminal cuttings were taken in late fall, rooted under intermittent mist during low light winter conditions, and evaluated 6 to 8 weeks later in most cases. Rooting percentages and a rooting index based on root mass were determined. Optimum auxin concentrations were: 1000 ppm for *Acalypha wilkesiana* (dwarf copper-leaf), 6250 ppm for *Aglaia odorata*, 500 ppm for *Duranta erecta* 'Alba', 6000 ppm for *Galphimia gracilis*, 1500 ppm for *Ilex vomitoria* 'Stoke's Dwarf', 6000 ppm for a *Rhododendron aurigeranum* × *R. herzogii* hybrid, 2500 ppm for *Thunbergia erecta*, and 1200 to 2250 for *Gardenia brighamii*.**

### INTRODUCTION

"Propagated by cuttings" is the usual notation for propagation information in many of the books that describe tropical ornamental plants (Chin, 2003; Rauch and Weisich, 2000; Sparrow and Hanly, 2002; Staples and Herbst, 2005; Whistler, 2000). Such information is not specific enough, especially for plants that are difficult to propagate by cuttings. The information provided in this paper was extracted from a series of plant propagation experiments set up for a plant propagation class at the University of Hawaii over several years. The objective was to inform students about how to take data and determine the best concentration in an auxin series for the propagation of a particular plant. Students had to prepare a write-up of the exercise as practice for future laboratory experiments.

### MATERIALS AND METHODS

The plant materials were: *Acalypha wilkesiana* (dwarf copper-leaf), *Aglaia odorata* (Chinese rice flower), *Duranta erecta* 'Alba' (golden dewdrop), *Galphimia gracilis* (thryallis), *Gardenia brighamii* (nanu, a native Hawaiian gardenia), *Ilex vomitoria*

**Table 1.** Plant materials, treatments, and conditions used for selected tropical ornamental cuttings.

Plant materials	Medium <sup>1</sup>	Date cuttings taken	Duration of rooting	Auxin <sup>2</sup> concentrations (ppm a.i.)
<i>Acalypha wilkesiana</i> (dwarf copper-leaf)	V:P	12/8/2004	6 weeks	DNG: 0, 500, 1000, 2000, 3000, 4000
<i>Aglaia odorata</i>	V:P	11/29/2001	11 weeks	DNG: 0, 1250, 2500, 3750, 5000, 6250, 7500
<i>Duranta erecta</i> 'Alba'	V:P	12/2/2000	6.5 weeks	IBA: 0, 500, 1000, 1500, 2000, 2500
<i>Galphimia gracilis</i>	V:P	11/25/2002	7 weeks	DNG: 0, 1000, 2000, 3000, 4000, 5000, 6000
<i>Ilex vomitoria</i> 'Stoke's Dwarf'	P:P	11/28/2000	7 weeks	IBA: 0, 500, 1000, 1500, 2000, 2500
<i>Rhododendron</i> hybrid	P:P	No record	8 weeks	DNG: 0, 500, 1000, 2000, 4000, 5000, 6000
<i>Thunbergia erecta</i>	P:V	12/2/2003	7 weeks	DNG: 0, 150, 450, 1000, 1500, 2000, 2500
<i>Gardenia brighamii</i>	V	2/12/97	10.3 weeks	DNG: 0, 1200, 2250

<sup>1</sup> V:P = 1:1 (v/v) vermiculite-perlite, P:P = 1:1 (v/v) peat : perlite, P:V = 1:1 (v/v) peat : vermiculite, V = coarse vermiculite.

<sup>2</sup> DNG = Dip 'N Grow (1% IBA, 0.5% NAA), IBA = indole-3-butyric acid.

'Stoke's Dwarf' (yaupon holly), *Rhododendron aurigeranum* × *R. herzogii* (an unnamed hybrid), and *Thunbergia erecta* (bush thunbergia). In most cases, the materials used for propagation were terminal cuttings about 4 to 5 inches in length. The lower one-third of foliage was removed prior to auxin treatment for ease of insertion into the medium. Cuttings were taken in late November or early December with the intention of reading results in mid- to late January in a plant propagation laboratory.

The auxin preparation was usually the commercial formulation Dip 'N Grow® (1.0% indole-3-butyric acid and 0.5% naphthalene acetic acid as active ingredients; Dip 'N Grow, Inc., Clackamas, Oregon), but indole-3-butyric acid dissolved in ethanol and diluted to desired concentrations with water was used for some plant materials (Table 1). Dilution series were prepared, but these were different from year to year (Table 1).

The basal 1/2 to 3/4 inches of stem was immersed in the auxin solution for 5 min for concentrations below 5000 ppm and 1 min for concentrations of 5000 ppm or higher. Cuttings were inserted into a medium of moist 1 vermiculite : 1 perlite (v/v) to a depth of about 1.5 inches. A medium of 1 peat : 1 perlite (v/v) was used for the *Ilex* and the *Rhododendron*, vermiculite only for the *Gardenia*, and peat-vermiculite for the *Thunbergia*. Three replicates of 10 cuttings per replicate were used for each treatment. Flats were placed under intermittent mist (8 sec on with 8 min between mist bursts during daylight hours). Ambient air temperatures ranged from 74–84 °F (day) to 65–72 °F (night). Light levels under saran shade were 70% of full sun (15–30 mol·m<sup>-2</sup>·day<sup>-1</sup> during December).

At the time of evaluation, usually about 6–8 weeks, cuttings were removed from the medium and rooted cuttings were counted and the rooting response

was assessed on the basis of ranks (Angelo, 1938). Rooting indices were calculated for each replication of each treatment using the methods of Mahlstedt and Lana (1958) and O'Rourke and Maxon (1948). Each cutting was assigned a value according to 5 = heavy rooting, 4 = medium rooting, 3 = light rooting, 2 = alive but no roots, 1 = dead. The rooting index was determined by summing the weighted values for each replicate of 10 cuttings and dividing by 10. The three replicate index values were averaged for each treatment. The percent rooting was determined for each replicate, and the three replicate values were averaged for each treatment. The classes did not conduct further statistical treatment such as analysis of variance and mean separations.

## RESULTS

Table 2 summarizes all rooting results.

*Acalypha wilkesiana* rooted well without auxins, but rooting percentage and root quality declined at 2000 ppm auxin and higher.

*Aglaia odorata* is considered difficult to root. The few cuttings that did root had medium to heavy root systems 11 weeks after sticking, and most of these were in the auxin concentrations of 2500 and 6250 ppm. The winter months may not be the optimum time of year for propagating this species.

*Duranta erecta* 'Alba' rooted readily, even without auxin, with many cuttings producing medium to heavy root systems in 6.5 weeks. Somewhat higher rooting indices were attained with the auxin treatments. With another few weeks in the propagation flat, all would have been heavily rooted.

*Galphimia gracilis* was difficult to root and lost many leaves under the intermittent mist regime. The best percentages of rooting and rooting index values were attained with the 2000 and 6000 ppm concentrations of auxin. The winter months may not be the best time for propagating this species.

*Ilex vomitoria* is considered moderately difficult to root (Berry, 1994; Duck, 1985; Gwaltney, 1992; Whitcomb, 1983), although 'Stoke's Dwarf' may be somewhat easier. In this experiment, auxin concentrations of 1500 and 2000 ppm yielded the best rooting percentage and root qualities.

*Rhododendron aurigeranum* × *R. herzogii* hybrid in the section *Vireya* was an unnamed cross created by Lyon Arboretum horticulturist Robert Hirano. *Rhododendrons* in this section are often easier to root than in species hailing from more temperate climates (Kenyon and Walker, 1997). The use of an auxin improved both the percentage rooting and root quality over nontreated cuttings, with the best results at the 5000 and 6000 ppm concentrations.

*Thunbergia erecta* rooted better when auxin was used, with the best result at the highest auxin concentration used in this experiment, 2500 ppm.

*Gardenia brighamii* is a rare species native to the Hawaiian Islands that is finding wider use as a landscape ornamental. Considered somewhat difficult to propagate, about two-thirds of the cuttings rooted at auxin concentrations of 1200 to 2250 ppm but required more than 10 weeks to do so. It is likely that a higher auxin concentration would provide better and faster rooting because Lilleeng-Rosenberg (2005) recommends a No. 16 rooting powder (presumably 1.6% IBA) for this plant.



## DISCUSSION

An auxin series ranging from 0–7500 ppm was an effective way to determine optimum concentrations for some tropical woody ornamental shrubs. Plant materials thought easy-to-root required less auxin to stimulate rooting than more difficult-to-root species. Care in selecting the type of cutting is necessary because uneven maturities of wood sometimes biased treatments, although replications were set up to balance numbers of cuttings with different maturities. These experiments were conducted during winter months in preparation for a plant propagation class to evaluate early in the spring semester, and results might have been better if propagation was done on newly matured summer or fall growth. These results, however, give an indication of auxin concentrations to try (where needed) for the species used in these experiments.

## LITERATURE CITED

- Angelo, E.** 1938. The use of chemicals in rooting raspberry leaf-bud cuttings. Proc. Amer. Soc. Hort. Sci. 36:129–130.
- Berry, J.** 1994. Propagation and production of *Ilex* species in the southeastern United States. Proc. Intl. Plant Prop. Soc. 44:425–429.
- Chin, H.F.** 1977. Malaysian Flowers in Colour. Tropical Press SDN. BHD. 29 Jalan Riong, 59100 Kuala Lumpur, Malaysia.
- Duck, P.H.** 1985. Propagation of *Ilex vomitoria* ‘Nana’. Proc. Intl. Plant Prop. Soc. 35:710–711.
- Gwaltney, T.** 1992. Dwarf yaupon holly, weeping yaupon holly, and azalea propagation at Flowerwood Nursery, Inc. Proc. Intl. Plant Prop. Soc. 42:369–374.
- Kenyon, J. and J. Walker.** 1997. Vireyas: A practical gardening guide. Timber Press, Portland, Oregon.
- Lilleeng-Rosenberger, K.** 2005. Growing Hawaii’s native plants. Mutual Pub., LLC, Honolulu, Hawaii.
- Mahlstede, J.P. and E.P. Lana.** 1958. Evaluation of the rooting response of cuttings by the method of ranks. Proc. Amer. Soc. Hort. Sci. 71:585–590.
- O’Rourke, F.L. and M.A. Maxon.** 1948. Effect of particle size of vermiculite media on the rooting of cuttings. Proc. Amer. Soc. Hort. Sci. 51:654–656.
- Rauch, F.D. and P.R. Weissich.** 2000. Plants for tropical landscapes: a gardener’s guide. University of Hawaii Press, Honolulu, Hawaii 96822.
- Sparrow, J. and G. Hanly.** 2002. Subtropical plants: A practical gardening guide. Timber Press, Portland, Oregon.
- Staples, G.W. and D.R. Herbst.** 2005. A tropical garden flora. Bishop Museum Press, Honolulu, Hawaii.
- Whistler, W.A.** 2000. Tropical ornamentals: A guide. Timber Press, Inc., Portland, Oregon.
- Whitcomb, C.E.** 1983. Rooting cuttings under a wet tent. Proc. Intl. Plant Prop. Soc. 32:450–455.

## The Micropropagation and Reintroduction into an Open Environment of Sterile *Plumeria rubra* Adult and Seedling Tissue®

**William S. Miller**

8 Solana Drive, Oroville, California 95966

**Richard A. Criley**

Department of Tropical Plant and Soil Sciences, University of Hawaii at Manoa, Honolulu, Hawaii 96822

**Plumeria, a tropical woody ornamental with attractive fragrant flowers, has been transported around the world and has recently become a collector's plant. New seed-derived cultivars are being introduced wherever the plant can be grown, but increase tends to be slow despite the ease of rooting of cuttings and grafting. Early efforts to tissue culture adult plant material were frustrated by microbial contamination. This study was initiated to determine efficient ways to micropropagate seedling and adult tissues. Six media based on the Murashige and Skoog medium with various amendments were evaluated. Juvenile tissue from seedlings derived from seed that had been surface sterilized and planted into sterile medium was used as an explant source, while adult tissues were derived from meristems dissected from axillary buds that were forced by decapitation of the main stem. Juvenile tissues were successfully subcultured in a Murashige and Skoog medium supplemented with Gamborg vitamins, 1 mg·L<sup>-1</sup> benzylaminopurine, 1 mg·L<sup>-1</sup> AgNO<sub>3</sub>, 500 mg·L<sup>-1</sup> casein hydrolysate, 20 g·L<sup>-1</sup> glucose, and 5 g·L<sup>-1</sup> agar. Rooting was also achieved in this medium. Adult tissue was slower to develop but demonstrated growth on a medium containing 1 mg·L<sup>-1</sup> kinetin. The use of AgNO<sub>3</sub> in the medium appeared to inhibit callus production and enhance shoot regeneration. Upon transfer into nonsterile conditions 82% of plantlets survived.**

### INTRODUCTION

Plumeria, a plant native to the New World tropics, has been successfully propagated, enjoyed, and spread worldwide by growers, aficionados, and scientists (Eggenberger and Eggenberger, 2000). The fragrant delicate blooms are the product desired by most, although other cultural and medicinal uses for plumeria have been noted such as the anesthetic qualities of *Plumeria rubra* sap (Chak and Patnaik, 1972).

Propagation of these plants has traditionally been through seedpod production, grafting, air-layering, and rooting of cuttings. In vitro tissue culture adds a new option by which growers, aficionados, and scientists can propagate and study this incredible genus. Studies of the plant can be traced back to collections of *P. filifolia* tissue out of Cuba by Mr. C. Wright (1856), one of which is on display on the web at the New York Botanical Garden. One hundred and forty-nine years later, study continues with enthusiasm and interest in the cultivation of plumeria has launched a thriving business in cutting and plant sales.



Early *in vitro* studies on plumeria occurred in India with Bhaumik et al. (1975) looking at the effects of plant growth regulators on the pH of the cells of bark, eventually arriving at an ideal pH of 5.8 for the cells. Later, attempts were made elsewhere to initiate growth of plumeria tissue *in vitro*, but those proved unsuccessful due to contaminants (Kunisaki, personal communication). Cytokinins, long used in tissue culture to stimulate shoot production, also enhanced branching of pruned stems (Kwon and Criley, 1991).

Miller's preliminary studies in 2003 helped confirm Bhaumik's research on pH and plumeria cells and provided the methods to acquire and clean tissue for sterile culture. The purposes of this study were to demonstrate the effects of six different media upon seedling and adult meristem tissue and to demonstrate a method for reintroduction of rooted plantlets.

## MATERIALS AND METHODS

**Media.** A prepared mixture of the basal salts for the Murashige and Skoog medium (Murashige and Skoog, 1962) was obtained from Phytotech Laboratories, as were the other ingredients that were employed in the different treatments.

- A. Murashige and Skoog basal salts ( $1.48 \text{ g}\cdot\text{L}^{-1}$ ) with Gamborg vitamins,  $1 \text{ mg}\cdot\text{L}^{-1}$  benzylaminopurine,  $1 \text{ mg}\cdot\text{L}^{-1}$  silver nitrate,  $500 \text{ mg}\cdot\text{L}^{-1}$  casein hydrolysate,  $20 \text{ g}\cdot\text{L}^{-1}$  anhydrous glucose, and  $5 \text{ g}\cdot\text{L}^{-1}$  tissue culture grade agar. Seedling tissue.
- B. Murashige and Skoog basal salts ( $1.48 \text{ g}\cdot\text{L}^{-1}$ ) with Gamborg vitamins,  $1 \text{ mg}\cdot\text{L}^{-1}$  benzylaminopurine,  $500 \text{ mg}\cdot\text{L}^{-1}$  casein hydrolysate,  $20 \text{ g}\cdot\text{L}^{-1}$  anhydrous glucose, and  $5 \text{ g}\cdot\text{L}^{-1}$  tissue culture grade agar. Seedling tissue.
- C. Murashige and Skoog basal salts ( $1.48 \text{ g}\cdot\text{L}^{-1}$ ) with Gamborg vitamins,  $1 \text{ mg}\cdot\text{L}^{-1}$  kinetin,  $500 \text{ mg}\cdot\text{L}^{-1}$  casein hydrolysate,  $20 \text{ g}\cdot\text{L}^{-1}$  anhydrous glucose, and  $5 \text{ g}\cdot\text{L}^{-1}$  tissue culture grade agar. Two additional media containing 1.5 and 2  $\text{mg}\cdot\text{L}^{-1}$  kinetin were also prepared. Seedling and adult tissue.
- D. Murashige and Skoog basal salts ( $1.48 \text{ g}\cdot\text{L}^{-1}$ ) with Gamborg vitamins,  $500 \text{ mg}\cdot\text{L}^{-1}$  casein hydrolysate,  $20 \text{ g}\cdot\text{L}^{-1}$  anhydrous glucose, and  $5 \text{ g}\cdot\text{L}^{-1}$  tissue culture grade agar. Seedling tissue.

**Media Preparation.** All ingredients, except agar were mixed into deionized water. The pH was adjusted to 5.8 and agar added. The mixture was heated to  $88^\circ\text{C}$  while stirring and then poured into culture vessels. All culture vessels ( $20 \text{ mm} \times 120 \text{ mm}$ ) were filled approximately 20%, capped, and autoclaved for 15 min at 15 psi.

**Adult Tissue Sterilization.** Recently formed tissue was selected showing neither cracks nor necrotic areas to avoid possible contamination from fungal spores. Stem tissue was collected from developing axillary buds from topped plants. These stems were approximately 4 cm in length. Prior to surface sterilizing, all expanded leaves were removed, the petioles being excised as close to the stem as possible.

The tissue was surface-sterilized by agitation for 35 min in a 10% sodium hypochlorite bleach solution with a few drops of surfactant added. It was then rinsed twice with sterile water and inserted approximately 2 cm into the medium, which had previously been aseptically broken with forceps. The culture vessels were sealed with Parafilm™ to reduce atmospheric gas exchange.

All culture vessels were placed in racks in an area maintained between 21–24 °C under broad-spectrum fluorescent lamps set for 14-h light periods. Those were checked periodically for contaminants and necrotic/abscised petiole tissue was removed as needed.

**Seed Sterilization.** Seed was soaked in deionized water for 8 h, then sterilized in a 5% sodium hypochlorite bleach solution with a few drops of surfactant added and agitated for ~5 min or until the seed coat became somewhat transparent. Those were then sterile rinsed twice and set radicle side down onto cotton bridges moistened by a solution containing half-strength Gamborg B-5 basal salts with 20 g·L<sup>-1</sup> anhydrous glucose. All germination vessels (same size as culture vessels), prior to setting of seed, had been autoclaved for 15 min at 15 psi.

Germination vessels were maintained between 21–24 °C under broad-spectrum fluorescent lamps set for 14-h light periods. Periodic checks for contaminants occurred, and observations for problems with the seed leaves pushing out of the seed coat were made, assisting the tissue as needed. After the germinated seedling tissue had developed at least four nodes, tips were sub-cultured onto various media.

**Transplanting of Rooted Seedling and Adult Plantlets.** After the tissue had developed into a plantlet with roots, it was extracted from the culture vessel and the roots were rinsed in sterile water and placed into a sterile growing medium consisting of equal parts of 1 sand : 1 perlite : 1 vermiculite (by volume) in 10-cm pots, placed into gallon-sized zip-type bags. The medium was moistened with deionized water, and the bags were then sealed and maintained between 21–24 °C under broad-spectrum fluorescent lamps set for 14-h light periods.

After 1 month, plantlets that had produced more than four nodes were transplanted into a medium containing 1 perlite : 3 potting soil (v/v), placed back into their respective bags, sealed, and maintained between 21–24 °C under broad-spectrum fluorescent lamps set for 14-h light periods. After one week the bags containing plants with potting soil were opened slightly to allow for gas exchange. As the plants matured, they were transplanted into 15-cm pots containing the same medium and moved outdoors.

Statistical analysis was performed upon plantlets placed upon Media A and B using a Wilcoxon Signed Rank Test at the 95% confidence level for bud break. Statistical analysis was also performed for callus production (on a scale of 0 to 5, 0 = no callus 5 = abundant callus) on plantlets set in media (1, 1.5, or 2.0 mg·L<sup>-1</sup> in Medium C containing kinetin using ANOVA at the 95% confidence level.

## RESULTS

**Adult Tissue.** Of the adult stem tissue that was placed on Medium C during the 60-day study period, all stem tissue placed survived and two-thirds had leaf primordial into elongated leaves.

**Seedling Tissue.** Medium A had the best overall effect upon seedling tissue by inhibiting callus formation and inducing buds to grow. Medium B had the worst overall effects upon seedling tissue by inducing heavy callus formation causing the tissue to quickly perish. Medium C, regardless of kinetin concentration, was intermediate in the effects it had upon both tissues, inducing callus formation, but not as heavily as that presented by Medium B. Medium D demonstrated results similar to that of Medium C.

Rooting was noted in both Media A and C. Medium A demonstrated an ability to induce elongation of dormant buds. In a comparison between Media A and B, five replicates each of seedling tissue, all tissue perished on Medium B, while the tissue placed upon Medium A survived the 60-day test period. Two stem sections that had dormant buds on Medium A produced one shoot each while one plantlet, which had a meristem, produced two additional shoots. Analysis showed a p value of 0.059 (Fig. 1). No statistical analysis was performed upon the vitality of seedling tissue between Media A and B, as all those in Medium B perished.

As seedling tissue was, for the most part, restricted to Medium C (except as noted in the previous paragraph) for propagation, no statistical analysis was performed to compare treatment differences between variants of this medium and Media A and B. However, two-month readings presented a statistical difference in callus production between Medium D and Medium C that contained 1.5 mg·L<sup>-1</sup> kinetin (Fig. 2). Seedling tissue greatly out-produced adult tissue during the 60-day study period producing 49 plantlets from the 14 sets, whereas the single explants remained as set.

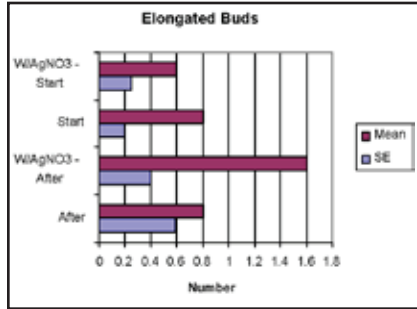
Transplanting from a sterile environment presented four fatalities out of 22 attempted; fatalities were associated with non-sterile pots.

**DISCUSSION**

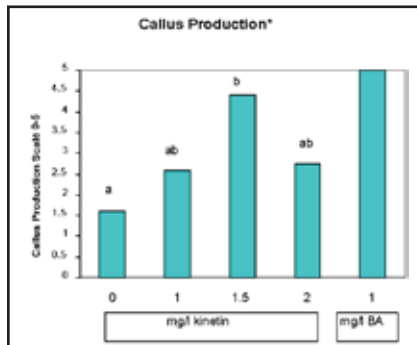
Seedling tissue replicates with ease, grows rapidly, and can be topped and sub-cultured multiple times. This would be especially important in the propagation of rare *Plumeria* species, such as *P. alba*, *P. filifolia*, *P. inodora*, *P. pudica*, *P. stenopetala*, and *P. stenophylla*. As in vitro culture presents the ability to maintain sterility, tissue can be multiplied and subcultured under controlled conditions, theoretically for an indefinite period of time.

Adult tissue culture does not yet replicate with the ease of seedling tissue. It is slower growing and larger in size, and topping/sub-culture has not yet happened. Two adult stems that have been transplanted from a sterile environment share the same ease for transplanting as demonstrated by seedling tissue.

The effects shown by Medium B may be related to the production of ethylene by the tissue, which then causes a “run-away” effect, and have been seen with media containing kinetin as well. Ethylene can diffuse through the inter-cellular spaces of a plant, and studies have shown that callus formation is



**Figure 1.** Average number of meristems for plantlets set upon mediums (a – no AgNO<sub>3</sub>) and (b – with AgNO<sub>3</sub>) after 60 days.



**Figure 2.** Callus production in response to kinetin and BA after 60 days.

\*Bars with different letters denote significant difference at the .05 level.

correlated to the amount of ethylene being produced by the tissues in culture and that ACC, an ethylene precursor, is responsible for the formation of callus (Tadeo et al., 1995). Zobel (1987) demonstrated the effects of gaseous compounds upon tissue contained within sealed vessels and that ethylene can rapidly accumulate to phytotoxic concentrations. The effects shown by Medium B suggest that this must be taken into account.

The addition of silver nitrate, an ethylene antagonist, appears to corroborate studies that have shown it significantly enhanced embryogenic callus production and increased shoot regeneration (Fei et al., 2000). By adding silver nitrate to the medium, the action of ethylene is slowed, which inhibits callus formation and cell enlargement, allowing for more normal growth. Initial studies demonstrated an extremely fast "run-away" effect upon the tissue with the addition of the auxin 2,4-D. As the tissue appears to root readily enough without the addition of an auxin and noting the deleterious effects that 2,4-D had upon the tissue, such agents were omitted. Sharad Tiwari (2003) pointed out the necessity to have levels of plant growth regulators that provide for good tissue growth and how the addition of silver nitrate helped maintain embryogenic status of androgenic calli in durum wheat more effectively than other media with 2,4-D alone.

Various challenges presented by the in vitro culture of plumeria are not impossible to overcome. Contaminates can still be a problem if strict adherence to aseptic technique is not followed. Responses to chemical stimuli are variable. Ethylene will be a problem for closed vessels, and plumeria tissue appears to readily produce this gas in vitro. Assuming control for the production of ethylene, maintenance of sterility of the tissue and culture vessel, and supply of nutrients in the media, one can theoretically multiply plumeria seedling tissue indefinitely.

## LITERATURE CITED

- Bhaumik, C., C. Sen, and P.C. Datta.** 1975. In vitro effect of hormones on bark of *Plumeria rubra* – Linn. var. *acutifolia* Bailey. Dev. Growth and Differ. 17(4):317–322.
- Chak, I.M., and G.K. Patnaik.** 1972. Local anaesthetic activity of *Plumeria rubra*. Ind. J. Pharm. 34(1):10–11.
- Eggenberger, R., and M.H. Eggenberger.** 2000. The handbook on *Plumeria* culture. 4th Edition. Tropical Plant Specialists, Cleveland, Georgia, 30528–2826.
- Kunisaki, J.T.** 2004. Personal communication. University of Hawaii at Manoa, Honolulu, Hawaii 96822.
- Kwon, E., and R.A. Criley.** 1991. Cytokinin and ethephon induce greater branching of pruned plumeria. Horticultural Digest of the University of Hawaii Cooperative Extension Service. 93:6–8.
- Maitra, R.K., and S.P. Sen.** 1989. Production of ethylene and ethane by callus tissues of *Daucus carota* L. in presence of 2,4-disubstituted phenols. Plant Sci. 62(1):33–35.
- Murashige, T., and F. Skoog.** 1962. A revised medium for rapid growth and bioassays with tobacco tissue cultures. Physiol. Plant. 15:473–498.
- Shuizhang, F., P.E. Read, and T.P. Riordan.** 2000. Improvement of embryogenic callus induction and shoot regeneration of buffalograss by silver nitrate. Plant Cell Tissue Organ Cult. 60(3):97–203.
- Tadeo, F.R., D. Tudela, and E. Primo-Millo.** 1995. 1-Aminocyclopropane-1-carboxylic acid-induced ethylene stimulates callus formation by cell enlargement in the cambial region of internodal explants of *Citrus*. Plant Sci. 110(1):113–119.
- Tiwari, S.** 2003. Anther culture and long-term culture ability of androgenic calli in durum wheat (*Triticum durum* Desf.). Wheat Information Service, No. 96:15–19. <<http://www.grs.nig.ac.jp/wheat/komugi/wis/wis.jsp>>
- Wright, C.** 1856. *Plumeria filifolia* Griseb. The New York Botanical Garden. Virtual Herbarium. <<http://207.156.243.8/emu/vh/specimen.php?irn=749625>>
- Zobel, R.W.** 1986. Gaseous compounds of soybean tissue cultures: Carbon dioxide and ethylene evolution. Environ. Exp. Bot. 27(2):223–226.

## The Propagation of Uluhe Fern (*Dicranopteris linearis*): Vegetative Versus Spores<sup>©</sup>

Ethan A. Romanchak, Richard A. Criley, and Nellie Sugii

Department of Tropical Plant & Soil Sciences, University of Hawai'i, 3190 Maile Way, Honolulu, Hawaii 96822

Uluhe fern, *Dicranopteris linearis* (Burm.) is an indigenous fern of the Hawaiian Islands. Because there is no established propagation method for this fern, a survey of propagation methods was conducted to determine a protocol suitable for large-scale production. For vegetative propagation, a layering and a division trial were performed in healthy, wild populations. The layering trial tested different concentrations of auxin. Rooted rhizomes and aboveground fern parts were transplanted from the wild into 3-gal pots for the division trial. Preliminary results have yielded no viable asexual method of propagation. For sexual propagation, aseptic cultures were established from spore germination on Steeves Medium (Steeves et al., 1955). Sporophyte genesis in aseptic culture has occurred, though sporophyte growth in vivo has not yet been measured. Preliminary results suggest that the successful propagation and production of uluhe fern will result from propagation by spores.

### INTRODUCTION

Uluhe fern (*Dicranopteris linearis*) is an indigenous fern that occurs on all of the main Hawaiian Islands in mesic and wet forests, often covering steep slopes from near sea level to 2,000 m. This species is an early colonizer of landslides and other disturbed sites where it may form dense thickets up to three m deep over large areas of open-canopy, oligotrophic, Hawaiian forests; this is in part due to its indeterminate clonal growth (Palmer, 2003). This fern species is also able to colonize and maintain dominance due to its shallow rhizomes, highly effective leaf area, and phosphorus use efficiency. Uluhe fern is also known to contribute to soil organic matter in the form of leaf litter as soil nitrogen and phosphorus is returned to the poor soils common in tropical ecosystems. And finally, uluhe fern may play an important role in resisting invasions of exotic species into Hawaiian forests due to its role in altering forest floor light regimes (Russell et al., 1998).

Among candidate species for large-scale restoration work in Hawaiian mesic and wet forests, uluhe fern is an obvious choice.

Currently, there is no available procedure to propagate and produce uluhe fern. The objective of this research was to compare vegetative propagation methods with propagation from spores for the production of uluhe fern.

### MATERIALS AND METHODS

**Vegetative Propagation: Layering Trial.** The auxins, indolebutyric acid (IBA 1%) and naphthaleneacetic acid (NAA 0.5%) (from Dip 'N Grow<sup>®</sup>), were sprayed on a scraped nodal section of the rachis of uluhe ferns in the wild. Four auxin treatment doses were used: 0, 500, 1,000, and 2,000 ppm. Twenty uluhe fronds were randomly chosen to receive one of the four-auxin treatments. Five replicates of each treat-

ment were performed. A mixture of moistened peat moss and uluhe leaf litter was wrapped around the treated rachis and covered with plastic wrap then aluminum foil. The 20 experimental units were checked at 4 and 8 weeks and rated for root development.

**Division Trial.** Terminal rhizomes of uluhe fern containing at least one frond and numerous roots were chosen from a single uluhe fern in the wild. The rhizome was severed from the mother plant then carefully dug and transplanted into the top inch of a 3-gal container filled with native soil. A total of 10 divisions were performed. Containers were kept under 50% shade, watered regularly, and monitored for survival for 8 weeks. The collection site and the division trial site were geographically adjacent; therefore environmental conditions for the division trial site were similar in light quality, day length, and air/soil temperature.

**Spore Propagation.** Fertile fronds of uluhe were collected from the wild on three of the main Hawaiian Islands (Hawai'i, Maui, and Oahu) for a total of six collections. Individual collections from single genotypes were not pooled. Fronds were left on paper for sporangia to dehisce and spores to disseminate. Approximately 25  $\mu\text{g}$  of uluhe spores from each collection were separated from sporangia using the static electricity created from a small piece of plastic wrap and tweezers; then both the plastic wrap and spores were placed into folded filter paper and secured by a paper clip. The spores were hydrated in water for 10 min and then sterilized in a 10% bleach solution containing 2 mL of Tween<sup>®</sup> with agitation for 20 min. Using aseptic techniques and working under a hood, spores were rinsed with sterile water and then blotted on sterile tissue to remove excess water from rinsing. Spores were sown on Steeves medium (Steeves et al., 1955) in 90-mm Petri dishes by opening up the folded filter paper containing the plastic wrap and the spores and then blotting the filter paper spore-side down onto the growth medium (plastic wrap was removed). Therefore, the 25  $\mu\text{g}$  of spores were evenly distributed over the surface area of the growth medium. The Petri dishes were sealed with plastic wrap and then placed under 12 h of broad spectrum light from fluorescent tubes at 35  $\mu\text{mol}\cdot\text{m}^{-2}\cdot\text{s}^{-1}$  in a controlled environment (23 °C). Growth and development were monitored using a dissecting scope weekly for 16 weeks.

## RESULTS

Vegetative propagation methods yielded no success. The nodal section of the rachis from the uluhe fern layering trial formed no adventitious roots or callus at any concentration of the applied auxin treatments during the 8-week trial. The division trial resulted in the death of all rhizome and frond tissues within 2 weeks of separation from the mother plant in the wild.

Propagation of uluhe fern from spores yielded numerous young sporophytes in vitro. Spores from each of the six collections started to germinate in 2 weeks. Prothalli formation occurred during Week 3 and continued developing until gametangia formation during Week 11. Fertilization and sporophyte genesis occurred over a 2-year period. In vitro 3-year-old sporophytes measure approximately 1.5 cm in height, though little effort had been made to encourage their development after they were formed. The sporophytes have not yet been moved to a Stage 4 medium.

## DISCUSSION

Based on results from preliminary trials, the superior propagation method of uluhe fern was propagation from spores. The layering trial was not expected to yield positive results due to the anatomy of the rachis vascular bundles.

The division trial also yielded no positive results. Disturbance to the root system was probably responsible for the immediate desiccation and resulting death of all the divided fern parts. Improved environmental conditions for the divided ferns might have helped survival.

A follow-up study was performed to test whether the division trial failed due to root disturbance or severance from the mother plant. Rhizomes were cut to separate the terminal end (including at least one frond) of the uluhe fern from the mother plant in the wild, but the division was never dug and transplanted leaving the roots undisturbed. The separated terminal end that would normally be dug and transplanted for a division perished within 4 weeks on all 20 of the trials performed. This suggests that division of uluhe fern fails due to disturbance to the roots as well as severance from the mother plant or insufficient root mass at the terminal end.

Efforts continue to increase fertilization and resulting sporophyte genesis for the propagation of uluhe fern from spores. The length of time for fertilization and sporophyte genesis to occur is too long for a commercial production system. Future trials will look at the effect of spore density, media composition, and environmental conditions that will result in increased sporophyte genesis.

Currently, young sporophytes from the wild are successfully being grown in 4-inch containers with native soil. If this species can be successfully grown in containers, then the propagation of uluhe fern from spores may allow for large-scale restoration of open, wet, disturbed sites in the valuable watersheds of the Hawaiian Islands.

## LITERATURE CITED

- Palmer, D.D. 2003. Hawai'i's ferns and fern allies. University of Hawai'i Press, Honolulu.
- Russell, A.E., Raich, J. W., and P.M. Vitousek. 1998. The ecology of the climbing fern *Dicranopteris linearis* on windward Mauna Loa, Hawaii. *J. Ecol.* 86:756–779.
- Steeves, T., Sussex, I.M., and C.R. Partanen. 1955. In vitro studies on abnormal growth of prothalli of the bracken fern. *Amer. J. Bot.* 42:232–245.



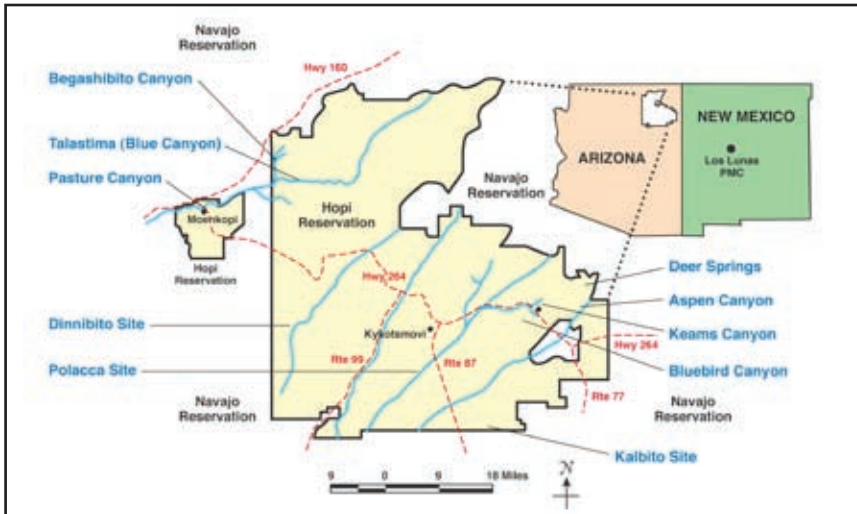
## Propagating Native Plants for the Hopi Nation®

Thomas D. Landis, David R. Dreesen, Jeremy R. Pinto, and R. Kasten Dumroese

Native Plant Nursery Consulting, 3248 Sycamore Way, Medford, Oregon 97504

### INTRODUCTION

The Hopi reservation is located in northeast Arizona (Fig. 1) where the tribe has been working to eradicate exotic salt-cedar (*Tamarix ramosissima* Leneb. [Tamaricaceae]) and Russian-olive (*Elaeagnus angustifolia* L. [Elaeagnaceae]) from streams and wetlands. Although only comprising about 2% of the reservation, these riparian and wetland communities are ecologically and culturally valuable for livestock grazing, wildlife habitat, traditional gathering, and ceremonial use (Lomadafkie, 2003). Even though the initial eradications were successful, the salt-cedar is already re-sprouting. Consequently, the tribe asked the U.S.D.A. Forest Service for help in propagating willows and cottonwoods to plant in these areas at the first Intertribal Nursery Council meeting in 2001.



**Figure 1.** Riparian and wetland restoration sites on the Hopi reservation are widely separated, and some contain natural clones of only one sex.

During initial visits to project areas on the reservation, we identified the principal riparian trees and shrubs: Fremont cottonwood, Goodding's willow, coyote willow, and arroyo willow. Tribal members also took us to remote sites where we found small stands of lanceleaf cottonwood, and quaking aspen (Table 1). It is important to note that many of the wetland and riparian areas on the Hopi reservation are geographically isolated and not always contiguous (Fig. 1). In addition, the aggressive invasion of salt-cedar and Russian-olive has severely reduced and separated the populations of native willows and cottonwoods. From our field observations, we suspected that several of the existing plant stands were comprised of only one sex and sometimes only a single individual (Pinto and Landis, 2003). For example, one extended stand of arroyo willow along Bluebird Canyon was found to contain only female plants, while a small grove of lanceleaf cottonwood at Deer Springs was observed to be all males (Table 1).

**Table 1.** List of important Salicaceae (cottonwoods, willows, and aspen) found on the Hopi Reservation, Arizona.

Scientific name	Common name	Form	Abundance	Sex of cuttings collected	
				Males	Females
<i>Populus fremontii</i> S. Wats.	Fremont cottonwood	Large tree	Common	X	X
<i>Populus</i> × <i>acuminata</i> Rydb. (pro sp.) [ <i>P. angustifolia</i> × <i>P. deltoides</i> ]	Lanceleaf cottonwood	Large tree	Very rare	X	
<i>Populus tremuloides</i> (Michx.)	Quaking aspen	Small tree	Very rare		
<i>Salix gooddingii</i> (Ball)	Goodding's willow	Small tree	Uncommon	X	
<i>Salix exigua</i> (Nutt.)	Coyote willow	Shrub	Common	X	X
<i>Salix lasiolepis</i> (Benth.)	Arroyo willow	Shrub	Rare		X

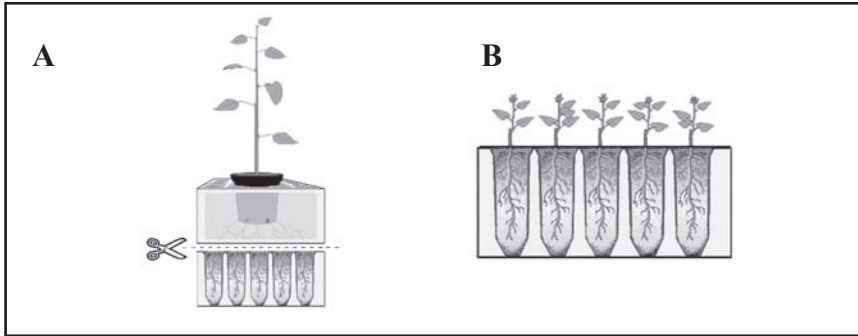
**WHY SEED PROPAGATION?**

Once the native plants had been identified, the next step was to determine where and how to propagate them. Because the Hopi do not have their own nursery, we did the initial propagation at the U.S.D.A. Natural Resources Conservation Service Los Lunas Plant Materials Center (PMC) in New Mexico (Fig. 1).

Traditionally, willows and cottonwoods are vegetatively propagated with woody cuttings but, because all Salicaceae are dioecious, we had concerns about using vegetative propagation (Landis et al., 2003). Therefore, to obtain the greatest possible genetic diversity and create plant communities that were self-sustaining, we decided to produce all our plant material from seeds. Our initial plan was to mix the rooted cuttings from different locations, allow them to flower and cross-pollinate, and produce locally adapted but genetically diverse seeds.

The literature suggested that rooted cuttings of mature plant material would flower in 1–2 years (Wycoff and Zasada, 2003; Zasada et al., 2003); accordingly, we collected cuttings during the winter dormant period and rooted them at the Los Lunas PMC (Landis et al., 2003). Unfortunately, this strategy didn't work. Although rooting success was acceptable, we only generated a small amount of seed from coyote willow.

So, we collected Fremont cottonwood and Goodding's willow seed, cleaned it, and sowed it immediately in Ray Leach Super Cells [164 cm<sup>3</sup> (10 inches<sup>3</sup>)]. Even though the seeds were collected in mid-June, we were still able to produce large seedlings by the end of September—a growing season of only 4 months. In fact, we decided to top prune these seedlings to maintain a favorable root-to-shoot balance.



**Figure 2.** Because traditional propagation techniques didn't work, we are using a new "stacked propagation" technique for quaking aspen.

### CONVENTIONAL PROPAGATION OF QUAKING ASPEN DIDN'T WORK

Woody cuttings of quaking aspen root poorly; however, forcing sprouts from underground stems and rooting them is effective. Although we collected underground stems of aspen from two locations, they did not produce sprouts. This may be due to the timing of the collections or the lack of vigor in the parent trees.

Therefore, we were excited when we noticed aspen catkins on some of the trees in Aspen Canyon. When they were taken to Los Lunas PMC and cleaned, however, the catkins yielded no viable seeds. On a subsequent trip, we collected some viable seed from healthier aspen stands on the adjacent Navajo Reservation. This time, the catkins did yield some viable seeds, and around a dozen seedlings were grown in 262 cm<sup>3</sup> (16 inches<sup>3</sup>) DeePots™ containers and later transplanted into 1-gal containers for further growth.

### STACKED PROPAGATION

In discussions with Larry LaFleur of Smoky Lake Nursery, we learned about a new vegetative propagation method for quaking aspen that we are calling "stacked propagation" (LaFleur, 2004). This technique takes advantage of the rapid and extensive root growth of aspen seedlings and the fact that severed roots will form new shoots. So, we created a stack of Styroblock® containers with a 3.785-L (1-gal) aspen seedling inserted in the top block. Lower blocks were filled with a growing medium of composted pine bark, pumice, and peat moss; a thin layer of media was also sandwiched between the blocks. After a few months, the roots of the aspen seedlings had grown down through the cavities in the lower blocks, and were cut with a sharp knife blade (Fig. 2A). Once the blocks were separated, new aspen shoots formed that grew into shippable plants in a few months (Fig. 2B).

In spite of its novelty, this is still vegetative propagation, and so, to ensure wide genetic variation, we will still try to collect more aspen seeds from the Hopi sites. We will also plant some of the Navajo aspen plants at these sites to encourage eventual cross-pollination.

## A CULTURAL PLANT PROPAGATION CENTER

With funding from the USDA Forest Service, we are working with the Hopi Tribe to develop a greenhouse at the Moenkopi Day School in Tuba City, Arizona. We are calling this facility a cultural plant propagation center (CPPC) because it will be used for growing native plants that have cultural value to the tribe. Located at a school, this nursery can also serve as an environmental education center that will bring together students and tribal elders. The CPPC will continue the plant propagation heritage of the Hopi, which is well characterized by this quote from the tribal website: “Farming and gardening are essential elements of Hopi culture—acts of faith that provide religious focus.”

## LITERATURE CITED

- LaFleur, L.** 2004. Personal communication. Smoky Lake (AB): Smoky Lake Nursery. Smoky Lake Nursery, Smoky Lake, AB, Canada
- Landis, T.D., D.R. Dreesen, and R.K. Dumroese.** 2003. Sex and the single *Salix*: Considerations for riparian restoration. *Native Plants J.* 4:109–116.
- Lomadafkie S.** 2003. Personal communication. Kykotsmovi (AZ): Hopi Tribe, Wetlands Coordinator.
- Pinto, J.R. and T.D. Landis.** 2003. Propagating plant materials for the Hopi Reservation, Arizona, p. 80-84. In: Riley LE, Dumroese RK, Landis TD, technical coordinators. National proceedings: forest and conservation nursery associations—2003. Ogden (Utah): USDA Forest Service, Rocky Mountain Research Station. Proceedings RMRS-P-38,
- Wycoff, G.W. and J.C. Zasada.** 2003. *Populus* L.: poplar, cottonwood, aspen. In: Woody plant seed manual.<<http://www.wpsm.net>>. (Accessed 15 Oct. 2004).
- Zasada, J.D., D.A. Douglas, and W. Buechler.** 2003. *Salix* L.: willow. In: Woody plant seed manual.<<http://www.wpsm.net>>. (accessed 15 Oct, 2004).

---

## General Session V: Question and Answer Session®

**Mike Bone:** I’ve worked with the tray-on-tray arrangement you mentioned and had problems with irrigations washing out the soil. I found you can take 50% shade cloth to place between the trays and the roots will grow through that into the bottom tray. This will also reduce soil compaction of the bottom tray by the top tray.

**Tom Landis:** Thank you, that’s good information. I’m anxious to see what we get with the oak and any of those species that are bunching or cloning species; you’d think it would work very well.

## A CULTURAL PLANT PROPAGATION CENTER

With funding from the USDA Forest Service, we are working with the Hopi Tribe to develop a greenhouse at the Moenkopi Day School in Tuba City, Arizona. We are calling this facility a cultural plant propagation center (CPPC) because it will be used for growing native plants that have cultural value to the tribe. Located at a school, this nursery can also serve as an environmental education center that will bring together students and tribal elders. The CPPC will continue the plant propagation heritage of the Hopi, which is well characterized by this quote from the tribal website: “Farming and gardening are essential elements of Hopi culture—acts of faith that provide religious focus.”

## LITERATURE CITED

- LaFleur, L.** 2004. Personal communication. Smoky Lake (AB): Smoky Lake Nursery. Smoky Lake Nursery, Smoky Lake, AB, Canada
- Landis, T.D., D.R. Dreesen, and R.K. Dumroese.** 2003. Sex and the single *Salix*: Considerations for riparian restoration. *Native Plants J.* 4:109–116.
- Lomadafkie S.** 2003. Personal communication. Kykotsmovi (AZ): Hopi Tribe, Wetlands Coordinator.
- Pinto, J.R. and T.D. Landis.** 2003. Propagating plant materials for the Hopi Reservation, Arizona, p. 80-84. In: Riley LE, Dumroese RK, Landis TD, technical coordinators. National proceedings: forest and conservation nursery associations—2003. Ogden (Utah): USDA Forest Service, Rocky Mountain Research Station. Proceedings RMRS-P-38,
- Wycoff, G.W. and J.C. Zasada.** 2003. *Populus* L.: poplar, cottonwood, aspen. In: Woody plant seed manual.<<http://www.wpsm.net>>. (Accessed 15 Oct. 2004).
- Zasada, J.D., D.A. Douglas, and W. Buechler.** 2003. *Salix* L.: willow. In: Woody plant seed manual.<<http://www.wpsm.net>>. (accessed 15 Oct, 2004).

---

## General Session V: Question and Answer Session®

**Mike Bone:** I’ve worked with the tray-on-tray arrangement you mentioned and had problems with irrigations washing out the soil. I found you can take 50% shade cloth to place between the trays and the roots will grow through that into the bottom tray. This will also reduce soil compaction of the bottom tray by the top tray.

**Tom Landis:** Thank you, that’s good information. I’m anxious to see what we get with the oak and any of those species that are bunching or cloning species; you’d think it would work very well.

## Evaluation of Seedling Quality and Planting Tools for Successful Establishment of Tropical Hardwoods®

### J.G. Mexal

Department of Agronomy and Horticulture, New Mexico State University, P.O. Box 3Q, Las Cruces, New Mexico 88003

### P. Negreros-Castillo

Centro de Investigaciones Tropicales, Universidad Veracruzana, Sistemas Sostenibles de Producción Forestal Ex-Hacienda, Lucas Martín Ave., Araucarias S/N Xalapa, Veracruz C.P. 91110 Mexico

### R.A. Cuevas Rangel

CENID-COMEF, Instituto Nacional Investigaciones Forestales y Agropecuarias (INIFAP), Coyoacán C.P. 04110, D.F. Mexico

### R. Moreno

Microseed Nursery, Ridgefield, Washington 98642

**Tropical forests are endangered from overexploitation of valuable timber species, especially *Cedrela odorata* (Spanish cedar) and *Swietenia macrophylla* (mahogany). These species naturally regenerate poorly, and artificial regeneration often results in poor survival. The objectives of this study were to evaluate the effect of planting tools and stocktypes on survival and early growth of these valuable hardwoods in enrichment plantings in Quintana Roo, México. Planting tools had no effect on seedling performance, although the local tool or "talacho" was preferred to the KB planting bar and flat, tree-dibble bar for making the planting hole. Seedling quality as measured by initial seedling diameter had a strong impact on both survival and growth at 28 months for both species. Stock type recommendations for enrichment plantings of mahogany and Spanish cedar are discussed and compared to recommendations for open field plantings.**

## INTRODUCTION

*Swietenia macrophylla* (mahogany) and *Cedrela odorata* (Spanish cedar) are valuable tropical hardwoods throughout central México and Latin America. However, annual harvest of both species is declining in México due to overexploitation. Fifty years ago, over 30,000 m<sup>3</sup> per year were harvested in the state of Quintana Roo, México (Cuevas, 1947), but only 10,000 m<sup>3</sup> were harvested in Quintana Roo in 1996 (Negreros, 1997). The decline in harvests has strained the economy of an economically depressed region. Fewer trees to harvest means harvesting costs are higher because trees are more difficult to find and travel distance between trees is greater.

The reduced occurrence of both mahogany and Spanish cedar is a function of both the rarity of these trees in the forests and the reproduction pattern of these species (Patiño, 1997). It is common for a forest to have fewer than seven trees of

both species per hectare (Snook, 2003). Furthermore, the natural regeneration of these species requires relatively large gaps in the forest for seedlings to establish. Generally, harvesting a few trees/ha may not create these gaps; precluding natural regeneration. Consequently, artificial regeneration is required.

The state of Quintana Roo plants about 4 million seedlings annually (Anon., 1997). However, survival has been low. Survival for enrichment plantings has been less than 20% for several communities (Negreros, 1997; Negreros and Mize, 2003), which is much lower than the national average of 50% (Anon., 1997) or the average for U.S.A. reforestation (Weaver et al., 1981).

Mahogany in this region traditionally has been produced in polybags, while Spanish cedar was produced as bareroot seedlings. Both species are rarely pruned, either the shoots (top-pruning or stripping of leaves) or the roots (stump planting), and seedlings are harvested and planted during the rainy season (May–September). Community members plant seedlings in logging roads or narrow clearings as enrichment plantings, using a sharpened stick and machete. Roots of the overstory trees are cut to make a planting hole in the rocky soil. The traditional planting technique uses a machete and large sharpened stick (5–7 mm in diameter). The stick can be used to plant about 10 seedlings before it has to be sharpened again. However, often the stick is dull, and the seedlings are planted too shallow.

The objective of this study was to evaluate planting tool use and stocktype on subsequent survival and early growth of mahogany and Spanish cedar in the state of Quintana Roo, México. In addition, a subset of the planting tool evaluation compared containerized seedlings to the conventional stock type of each species.

## MATERIALS AND METHODS

Quintana Roo is located at about 20 north latitude and 86–89° east longitude on the Yucatán peninsula of México at an elevation less than 10 m. The state has nearly 350,000 ha of dry tropical forest and receives about 1,300 mm of precipitation per year primarily in July through September (Escobar, 1986). Over 80% of the inhabitants are indigenous Mayan, with most living in small communities (Negreros, 1997). This study was conducted in two of these communities (“ejidos”).

**Limones Ejido Cafetal.** Spanish cedar and mahogany seedlings were grown in the San Felipe Bacalar nursery operated by Instituto Nacional de Investigaciones Forestales y Agropecuarias (INIFAP) (National Institute for Research in Forestry, Agriculture and Animal Husbandry). Spanish cedar seedlings were grown as bareroot seedlings with uncontrolled growing density. Mahogany seedlings were grown in gusseted polybags (10 cm in diameter [open] × 19 cm in height) filled with native soil. Containerized seedlings grown at New Mexico State University in 164-ml Ray Leach tubes at a growing density of 527 per m<sup>2</sup> were also used in the planting demonstration.

Three metal planting tools were evaluated: KB bar, traditional flat planting bar, and “talacho” or traditional agricultural planting tool. The talacho is a flat-bottomed, sharpened blade used for cutting roots.

The planting site consisted of planting 2-m wide lines cleared in the understory of a naturally regenerated forest. The site was a secondary forest about 15 years old and around 8 m tall that was considered by the local people as a “mahogany site.” Three replications of each tool were planted. The first two replications consisted of ten seedlings each of bareroot Spanish cedar and polybag mahogany seedlings. The



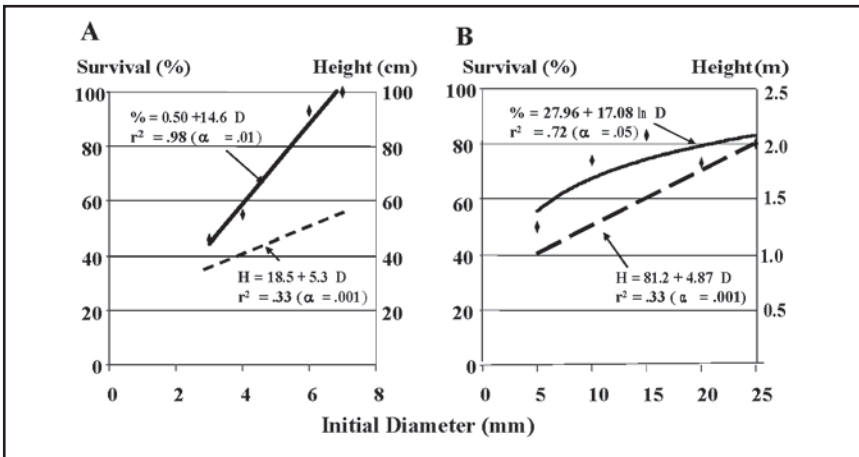
third replication of both species consisted of seven containerized seedlings of cedar and mahogany. Seedlings were planted 9 Oct. 1995 by community members. Following planting, seedling height and groundline diameter were measured. Seedling survival and growth were monitored over the next 28 mo.

**Laguna Kaná.** Spanish cedar and mahogany seedlings were grown at the Laguna Kaná nursery. Mahogany was grown in polybags (10 cm in diameter [when open] × 19 cm in height) filled with a 1 native black and red soils : 1 Spanish cedar (v/v) mixture as bareroot seedlings. Containerized seedlings grown at New Mexico State University were also used in the planting demonstration.

A planting design similar to the Limones Ejido Cafetal study was used. The site was an old mahogany plantation about 20 years old and 10 m tall. Three replications of each tool were planted. The first two replications consisted of 7 to 10 seedlings each of bareroot Spanish cedar and polybag mahogany seedlings. The third replications consisted of nine containerized seedlings of both Spanish cedar and mahogany. Seedlings were planted 6 Oct. 1995 by community members. Following planting, seedling height and groundline diameter were measured. Seedling survival and growth were monitored over the next 28 mo.

## RESULTS

**Planting Tool Evaluation.** Workers preferred the talacho because it cut the roots of the overstory trees better than the tree planting tools or the traditional sharpened stick, which was not evaluated. Furthermore, the soil did not adhere as readily to the talacho as to the other tools. The talacho cut roots better than even a machete. The KB bar did not cut the roots and appeared to compact the soil. The foot peg on both forestry-planting tools (dibble bar and KB bar) often became entangled in the roots of overstory trees, reducing planter productivity. Furthermore, the foot peg was not usable because the workers wore thin sandals. Even with the metal tools, the planting hole appeared to be too small, occasionally resulting in shallow planting of all stock types. Beyond worker preference, planting tools had no obvi-



**Figure 1.** (A) Relationship between initial seedling diameter of *Cedrela odorata* and survival and growth after 28 month on the Limones site. (B) Relationship between initial seedling diameter of *Cedrela odorata* and survival and growth after 28 months on the Laguna Kaná site.

**Table 1.** Survival and growth by stocktypes of Spanish cedar and mahogany seedlings planted in Limones and Laguna Kaná. There are significant differences among means only where noted. Means followed by the same letter are not significantly different ( $\alpha = 0.05$ ).

Tool	Survival (%)	Height (cm)		Diameter (mm)		Tool	Survival (%)	Height (cm)		Diameter (mm)	
		Initial	Final	Initial	Final			Initial	Final	Initial	Final
		Limones – Spanish cedar						Limones – mahogany			
Bareroot	50 a	18 ns	32 a	3 a	7 ns	Polybag	90 a	46 a	119 a	5 ns	16 a
Container	95 b	21 ns	52 b	6 b	10 ns	Container	76 b	17 b	59 b	4 ns	9 b
		Laguna Kaná – Spanish cedar						Laguna Kaná – mahogany			
Bareroot L	70 ns	104 a	172a	17 a	25 a	Polybag	80 a	48 a	132 a	6 ns	17 ns
Bareroot S	56 ns	29 b	130b	6 b	17 ab	Container	26 b	14 b	108 b	3 ns	14 ns
Container	74 ns	18 b	95 c	6 b	12 b						

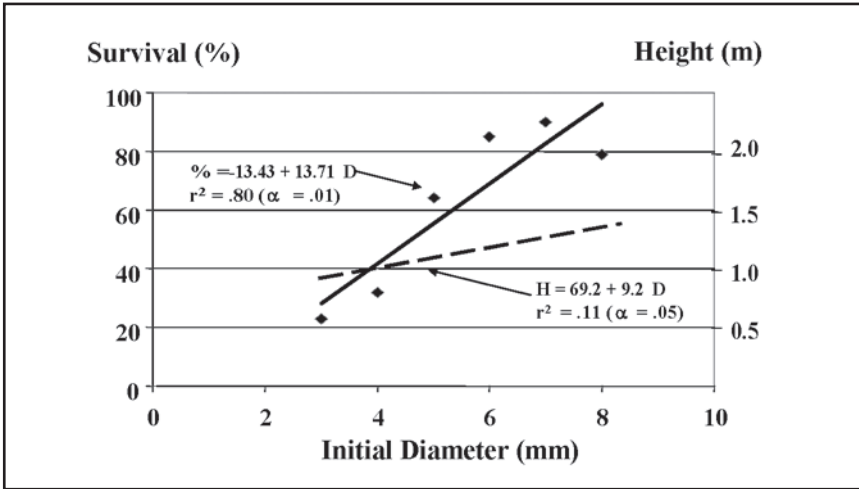
ous effect on survival or growth of either species at the two planting sites (data not shown).

**Stocktype Evaluation.**

**Limones Ejido Cafetal, Spanish cedar.** Stock type had a strong effect on both survival and growth (Table 1). Containerized seedlings had higher survival (95%) and more importantly, no mortality beyond the establishment period. The bareroot Spanish cedar seedlings were out of the soil for several hours before planting and appeared somewhat wilted at time of planting. Bareroot seedling survival was 82% after 8 months, but dropped to 50% over the next 20 months. The difference between stock types appears to be related to initial seedling size. The containerized seedlings were larger at time of planting. Larger seedlings had better survival and growth after 28 months (Fig. 1A). The best survival and growth was with seedlings that had a diameter of at least 6 mm.

**Limones Ejido Cafetal, mahogany.** Stock type had a strong effect on both survival and growth (Table 1). Polybag seedlings were larger initially and had better survival and growth than containerized seedlings. Neither stock type suffered significant mortality beyond the establishment period. Height at 28 months, but not survival, was weakly correlated with initial seedling diameter. However, the larger polybag seedlings resulted in seedlings that were twice the height of containerized seedlings after 28 months.

**Laguna Kaná, Spanish cedar.** Seedling quality had a strong effect on both survival and growth, and stock type affected growth (Table 1). Containerized seedlings had higher survival the first year (100%) and 74% after the next 20 months. Bareroot seedling survival was 81% after 8 months and dropped to 63% over the next 20 months. However,



**Figure 2.** Relationship between initial seedling diameter of *Swietenia macrophylla* and survival and growth after 28 months on the Laguna Kaná site.

there was a strong interaction between survival and seedling size. Replication 1, which averaged 104 cm in height and 17 mm in diameter, had 70% survival after 28 months, while Replication 2, which averaged 29 cm in height and 6 mm in diameter, had only 56% survival after 28 months. Containerized seedlings (Replication 3) were small (18 cm height and 6 mm diameter), but survived well (75%). Both survival and growth were correlated with initial seedling diameter (Fig. 1B). Larger seedlings had high survival and were nearly 2 m tall after 28 months. Growth was only weakly correlated as diameter explained only 33% of the variation in height.

Laguna Kaná mahogany stock type had a strong effect on both survival and growth (Fig. 2). Containerized seedlings had poor first-year survival. Survival of containerized was 29% in May 1996 and 26% after the next 20 months. Polybag seedling survival was 88% after 8 months, but dropped only to 80% over the next 20 months. There was a strong correlation between survival and seedling size and a weak correlation between size and height growth (Figure 2).

## DISCUSSION

**Planting Tool Evaluation.** Enrichment planting under native forests requires a tool to cut through overstory tree roots. Traditionally, the roots are cut with a machete and a hole dug with a planting stick. Conventional tree planting tools were not as effective in cutting roots as the talacho. Furthermore, this tool is readily available, inexpensive, and can be attached to wooden handles cut from saplings in the forest. This tool should be more effective than a simple wooden stake. Regardless of the tool selected, close inspection to ensure the seedlings are planted to the proper depth is critical (Randall and Johnson, 1998).

**Seedling Quality.** Seedling size more than stock type was a better predictor of performance with these tropical hardwoods. Polybag-grown mahogany seedlings, with

the larger leaf area and intact rootball, outperformed container-grown seedlings on both sites. The results were mixed with the bareroot Spanish cedar seedlings. The larger bareroot seedling had better growth than containerized seedlings on the Laguna Kaná site. However, the containerized Spanish cedar seedlings were larger than the bareroot on the Limones site, and subsequent performance was better for containerized seedlings.

Combining the data from both the Limones and Laguna Kaná sites illustrates the importance of seedling size in determining seedling survival. There was a strong correlation between initial seedling diameter and seedling survival. The equations were:

$$\text{Mahogany \%} = 27.83 + 8.49 (\text{Di}) \quad r^2 = .76$$

$$\text{Cedar \%} = 9.76 + 10.29 (\text{Di}) \quad r^2 = .82$$

For both species, the best survival was obtained when the seedlings had an initial diameter of at least 6 mm. This size is larger than that reported by Mexal et al. (2002), who reported seedlings should be at least 4 mm. However, that study was in an abandoned field with less initial overstory competition. Enrichment plantings such as this, where overstory trees compete for light and water, require larger seedlings. In general, seedling survival was 48% with a diameter less than 5 mm, while it was over 80% with a diameter over 6 mm.

Napier (1985) proposed a target seedling diameter of 5-10 mm for tropical hardwoods in Central America. This recommendation would seem to hold for México as well. However, few studies appear to follow this target guideline. Macario and Sánchez (2000) reported survival of enrichment plantings after two years of 40% for mahogany and 31% for cedar. These seedlings were small (<30 cm in initial height) and grew poorly (15 cm) following outplanting. Wightman (2000) had better survival, but the largest seedlings were only 7 mm for Spanish cedar (42% survival) and 5 mm for mahogany (50% survival).

Growth following outplanting was also related to seedling size, but was confounded by species and site. The Laguna Kaná site was better than the Limones site. Growth of both species was better on the Laguna Kaná site. Furthermore, growth of the containerized seedlings, which were similar in initial morphology, was about 80% greater on the Laguna Kaná site. Regardless, larger seedlings will likely result in long-term growth differences (Dierauf and Garner, 1996; South et al., 1988).

There appeared to be no advantage to using a containerized system to produce either species. Container seedlings were more expensive to produce and often smaller than either bareroot or polybag-grown seedlings. The polybag-grown seedlings grown at two nearby nurseries were similar in size. They were grown in similar soils under natural precipitation without fertilization.

Patiño (1994) reported mahogany seedlings planted after a hurricane in 1971 had 86% survival and were 5.4 m after 9 years (~ 55 cm/year), whereas Spanish cedar was only 3.3 m (~ 33 cm/year) with only 25% survival. In this study, growth of mahogany after only two growing seasons was comparable to the growth reported by Patiño (1994), while Spanish cedar survival and growth were substantially better in this study. Furthermore, Mexal et al. (2002) reported much better growth of mahogany on sites with better site preparation. Thus, site preparation, proper planting, coupled with high seedling quality can result in enrichment plantings with excellent growth potential.

## LITERATURE CITED

- Anon. 1997. National reforestation program. México. Dept. of Social Development, México. ISBN: 968-838-397-X.
- Cuevas López, A. 1947. Explotación de tres especies forestales y propagación artificial de mahogany en Quintana Roo. B.S. Thesis Escuela Nac. de Agricultura, Chapingo, México.
- Dierauf, T.A. and J.W. Garner. 1996. Effect of initial root collar diameter on survival and growth of yellow-poplar seedlings over 17 years. *Tree Planters' Notes* 47:30–33.
- Escobar Nava, A. 1986. Geografía General del Estado de Quintana Roo. 2nd ed. Quintana Roo State Govt.
- Macario Mendoza, P.A. and L.C. Sánchez Pérez. 2000. Enriquecimiento de acahuals mediante la reforestación de mahogany y cedro, en el ejido X-Hazil y anexos, Felipe Carrillo Puerto, Quintana Roo. In: Proc. Congr. Nacional de Reforestación, Texcoco, México. Nov. 8–10, 2000.
- Mexal, J.G., R.A. Cuevas Rangel, P. Negreros-Castillo, and C. Parraguirre Lezama. 2002. Nursery production practices affect survival and growth of tropical hardwoods in Quintana Roo, México. *Forest Ecology and Management* 168(1-3):125–133.
- Napier, I. 1985. Técnicas de viveros forestales con referencia especial a Centroamérica. ESNACIFOR, Siguatepeque, Honduras, CA. Nota Técnica No. 5.
- Negreros Castillo, P. 1997. Evaluación de la sustentabilidad del sistema de manejo forestal de la organización de ejidos productores forestales de la Zona Maya de Quintana Roo. Report submitted to the Rockefeller Foundation, México City.
- Negreros Castillo, P. and C. Mize. 1993. Effects of partial overstory removal on the natural regeneration of a tropical forest in Quintana Roo, México. *Forest Ecology and Management* 58:259–272.
- Patiño Valera, F. 1994. Algunas experiencias de investigación y desarrollo de tecnologías para plantaciones forestales, p. 233–269. In: Plantaciones: Producir para Conservar. Proc. IV Reunion Nacional de Plantaciones Forestales. INIFAP, México.
- Patiño Valera, F. 1997. Genetic resources of *Swietenia macrophylla* and *Cedrela odorata* in the neotropics for coordinated action. FAO For. Gen. Res. No. 25: 20–31.
- Randall, W. and G.R. Johnson. 1998. The impact of environment and nursery on survival and early growth of Douglas-fir, noble fir, and white pine—A case study. *Western Journal of Applied Forestry* 13(4):137–143.
- Snook, L.K. 2003. Regeneration, growth and sustainability of mahogany in México's Yucaton forests, p. 169–192. In: A. E. Lugo, J. C. Figueroa Colon, M. Alayon (eds.) Big-leaf mahogany: Genetics, ecology, and management, Ecological Studies, Vol. 159, Springer-Verlag, New York.
- South, D.B. J.G. Mexal, and J.P. van Buijtenen. 1988. The relationship between seedling diameter at planting and long-term growth of loblolly pine in east Texas, p. 192–199. In: Proc. 10th North Amer. Forest Biol. Workshop, Vancouver, B.C. Canada.
- Weaver, G.H., B. Izla, F.S. Broerman, and K. Xydias. 1981. Preliminary report on the 1979 American Pulpwood Association pine plantation survival and nursery practices survey, p. 24–30. In: Proc. 1980 South. Nursery Conf., Lake Barkley, KY, Sept. 2–4, 1980. USDA Forest Service-State and Private Forestry Tech. Pub. SA-TP17.
- Wightman, K. 2000. Técnicas para mejorar la calidad de planta en vivero: ejemplos con cedro (*Cedrela odorata*) y mahogany (*Swietenia macrophylla*). Proc. Congr. Nacional de Reforestación, Texcoco, México. Nov. 8–10, 2000.

## General Session VI: Question and Answer Session<sup>©</sup>

**Dale Pollard:** I was under the impression that once you slashed and burned a jungle forest area it really didn't rejuvenate itself very effectively, but you mentioned that it does. I was wondering whether you could elaborate on that?

**Raul Moreno:** I am halfway guessing here, but I think that part of it has to do with the size of the clear-cut and the shape of it to allow for the plant material and seed to move in. If it's done over a very large area, regeneration will be difficult.

**Dave Hannings:** Could trees be planted in the cleared area while you're growing corn or whatever so they could be growing a year or two?

**Raul Moreno:** Yes, that would be more of an agroforestry approach.

**Douglas Justice:** Do we know what the *Plectranthus* species is?

**Scott Trees:** It's a hybrid, and I don't know what the exact species is.

**Douglas Justice:** These cuts that are being made in the forest are corridors with relatively few species being planted in them. Is that not confounding the whole issue of biodiversity? If you have a corridor, won't pests be able to move along the corridor and make a mess?

**Raul Moreno:** This corridor closes up very fast. Remember, you're opening the corridor with machetes and so you're actually just pruning whatever is there. Part of the follow-up that is sometimes not done is that the plants take at least a season or two to become established. The other issue there is light. These corridors need to be wide enough for the corn.

**Richard Criley:** Would you comment briefly on Ball's agreement with the South Africans for your exclusive rights to these plants?

**Scott Trees:** Ball has an agreement with the Kirstenbosch National Botanic Gardens in South Africa. Part of that agreement is in exchange for funding we've given to Kirstenbosch to build a greenhouse and buy vehicles: we get first right of refusal on germplasm coming from their scientists to use in our breeding programs. Anything that's developed in our breeding programs we pay royalties back to the South African government.

**Steve McCulloch:** With the *Salvia* breeding, what is meant by mutation breeding? Are you irradiating seeds or plants? What kind of irradiation are you doing and how does that enter into the breeding?

**Scott Trees:** We use a couple types of irradiation in our breeding programs. Originally, we were working only with gamma irradiation, but we're working with other types now. We irradiate cuttings or small liners (rooted cuttings) where we get a better survival rate.

**Kathy Echols:** With *Perilla frutescens* var. *purpurascens* 'Magilla' now being a little different, will this change the patent restrictions on it since it was patented under a particular name?

**Scott Trees:** *Perilla* 'Magilla' wasn't patented. The name was trademarked, but it wasn't a patentable plant and the reason for that is that the plant was already

being sold in Japan. In the U.S.A., if a plant has been sold for a year anywhere else in the world you can't patent it. However, we did mutation breeding on this cultivar and got out a green variant we called Magilla Perilla Vanilla that is a green and creamy colored plant. That one we can patent since we changed the nature of it.

**Kristin Yanker-Hansen:** For the irradiated plants, how long have they existed and is there any possible reversion back to the original?

**Scott Trees:** There probably will be reversions back. This plant has only been around for 2 years, and I haven't seen any reversions, but in other examples of mutation-breeding plants from other companies I've seen reversion after several years. It's a big part of the quality control to maintain stock plants that have not reverted.

**Paolo Sangankeo:** In traditional breeding of something like the *Plectranthus*, how many generations before you get to where you want to be?

**Scott Trees:** It depends on the crop and what the ploidy level is of the plants you're working with. Breeders are always looking for faster ways of getting things onto the market. We are always looking for short cuts, for example, using tissue culture or multiple trialing sites. When we create a new product we trial it to make sure that it's what we say it's going to be. Traditionally, companies do two or three trials a year; we do 14 trials a year around the world. We trial that plant in California, greenhouse and field, in Illinois, Florida, Holland, and with selected growers around the world. After a year's trial we have 28 evaluations and we feel confident we can introduce a plant in 1 year after it's been selected. The average amount of time breeding the plant is 3 years from start to finish.

**Vernon McQueen:** On the corridors, how wide are they and how far apart are they in the forest?

**Raul Moreno:** I believe they are 2–3 meters wide and a minimum of 5 m apart. They follow the contour of the land on which they are located.



---

## TECHNICAL SESSIONS

### MONDAY MORNING, 24 OCTOBER, 2005

The 30th Annual Meeting of the International Plant Propagators' Society – Southern Region of North America convened at 7:45 AM at the Hilton/University of Florida Conference Center Gainesville, Florida, with President Bill Turk presiding.

#### PRESIDENT BILL TURK

President Turk welcomed everyone to Gainesville, Florida, for the 30th Annual Meeting of the International Plant Propagators' Society – Southern Region of North America. He thanked Local Site Committee Chair Alan Shapiro and his committee for the long hours in arranging the excellent tours, hotel, conference arrangements, other planning activities, and all their attention to detail. He encouraged all students, new members, and perspective new members to attend the 1st annual reception prior to the banquet and auction, so they could catch the uniqueness and spirit of the I.P.P.S. that makes it special — “to seek and share.” Turk also encouraged all members to make new members and attendees feel welcome — share with them and seek from them. He also thanked Program Chair and 1st Vice-President Bob Smart for the excellent program and slate of speakers.

#### LOCAL SITE COMMITTEE CHAIRMAN ALAN SHAPIRO

Chairman Shapiro welcomed everyone to Gainesville. He mentioned that he and his committee had been planning for this meeting for the past 5 years and that it was an honor to have the IPPS – SRNA come to Gainesville, Florida, and to meet and tour local nurseries. He thanked his local site committee for all of their help: Bill Reese, Chris Reese, David Reese, Jim Salmon, Carl Sherman, Mike Marshall, Bob Byrnes, Dr. Tom Yeager, and Hugh Gramling. He also thanked the University of Florida and the Department of Environmental Horticulture program. He then introduced Dr. Joe Joyce, Executive Associate Vice-President of IFAS of the University of Florida. Joyce welcomed the IPPS members and gave an overview of the University of Florida and the importance of the \$9.1 billion Florida green industry.

#### PROGRAM CHAIR BOB SMART

Chairman Smart welcomed all members and guests. He thanked the membership for the opportunity to serve them and then reviewed the scheduled program. The Question Box was scheduled for Tuesday evening to be co-chaired by Dr. Tom Yeager and Kevin Gantt. He thanked Dr. Glen Fain for his audio and video efforts. Smart then introduced Buster Corley to moderate the 1st session.

## New Plants for the South®

**Ted Stephens**

Nurseries Caroliniana, Inc., 22 Stephens Estate, North Augusta, South Carolina 29860

### INTRODUCTION

As a smaller nursery in the playing field of many giants, we have found our niche in the marketplace by offering new or newer selections that are not readily available from larger nurseries. It is quite a challenge to find new cultivars, which will tolerate both the heat and humidity of the U.S.A. Deep South. Probably more of a challenge than finding a plant that will tolerate the ambient air temperature is finding one that will tolerate our warm, damp, late-summer soil temperatures. More often than not, if a selection fails, it is due to root problems, usually a fungus, rather than any problem above the soil line. Often, the geographical origin of a plant will have much to do with its adaptability. It has been our experience that species that are native to Chile will almost inevitably succumb, whereas plants native to New Zealand, with a similar climate, will often perform admirably. Hence, proper trialing is eminently important. Of course, being able to mass propagate a new accession is also an important issue that one must address.

The sources of our new selections are domestic as well as international. We have developed a number of our new introductions on site — from seed or propagating sports. So these are usually from a plant that has already been established as an adaptable plant to our conditions. We determine if our selections are stable and able to be easily propagated. Avid hobbyist gardeners share a number of selections with us as well. But we will also take advantage of other smaller nurseries similar to ours that are avidly searching for new introductions. Foreign acquisitions are another one of our sources. Many new selections have resulted from travels to Japan and Europe — and are a result of cultivating friendships and mutual sharing of our own selections with these sources.

***Gordonia axillaris* (syn. *Polyspora axillaris*), fried egg plant.** A popular winter-flowering large shrub to small tree of 3 to 4.6 m (10 to 15 ft) from Australia. Its name comes from its habit of dropping its 10-cm (4 inch) white flowers intact to the ground, face up with its prominent brilliant yellow stamens displayed in full view against its ivory white petals. This is considered an ornamental trait “down under” but may be frowned upon by some fastidious gardeners. Its evergreen leaves closely resemble our native *G. lasianthus* with a length of 10 to 15 cm (4 to 6 inches), glossy and dark green. It is a late fall bloomer with 3 to 8 flower buds clustered around the terminal buds of a branch. Hence when in flower, it is extremely showy over several months from October to December. It propagates rather well from semihardwood cuttings in the fall. This plant is purported to be sensitive to low temperature, but we have found it to be quite hardy in mid Zone 8 down to -10 °C (14 °F). Zones 8–10.

***Michelia* (syn. *Magnolia*) *maudiae*, smiling forest michelia.** Since *Michelia* has been placed into the *Magnolia* genus, it will probably take some time before one will become comfortable with calling *Michelia* “*Magnolia*.” This species gets quite large in its native China, reaching heights of 30.5 m (100 ft), but we would prob-

ably consider it a medium-size tree, even though it will grow 1 m (3.3 ft) or more per year in its early development. The foliage is evergreen with a bluish-green color and silvery undersides. It is extremely fragrant, with white flowers up to 14 cm (5.5 inch) in diameter. The biggest problem is that it is a late-winter bloomer, which makes it quite vulnerable to late freezes. But, even with one good flowering year in three, this selection is worth planting. A mature plant will set flower buds at almost every node, leading to a memorable horticultural experience of a tree in full flower in February or March.

Propagation can be a problem, since it is difficult to root by cuttings with only a 10% to 20% success rate. It grafts well, using *M. kobus* as a rootstock. In the past we have been importing seedlings directly from China, but now that more mature plants are developing in the U.S.A. Southeast, good seed set occurs here. If seed are collected in the fall and cleaned and planted immediately, germination will begin in days. We place community seed pots in a cold frame for the winter with enough heat to keep them just above freezing. Germination will continue all winter with 76 to 102 cm (30 to 40 inches) of growth experienced through the following growing season, when plants are then separated to individual 3- to 7-gal containers. Flower buds will be set on plants as young as 2 to 3 years from seed. One must diligently protect planted seed from mice, as they relish the seed of this species. We tightly staple fiberglass screening over each pot to prevent damage. Its range will probably be limited to Zones 7b to 9 and possibly 10.

***Edgeworthia chrysantha* 'Winter Gold', paper-bark bush.** This is one of those exceptional winter flowering shrubs for the South that not only gives a great floral display, but also has a wonderful fragrance. It has been said that every U.S.A. southern garden needs an *Edgeworthia*. I could not agree more. In the same family with *Daphne*, *Thymelaeaceae*, this species resembles the daphne inflorescence with its prominent, terminal flower buds that form in the fall and remain prominent throughout the winter with their covering of silvery indumentum. Since it is deciduous, the silky flower buds are an additional winter attraction, opening here starting in late January and continuing well into March. Its 5 to 14 cm (2 to 2.5 inch) bright golden-yellow flower heads consist of 70 to 90 or more individual, small flowers. It tends to be a multi-branched shrub of 1.8 to 2.4 m (6 to 8 ft) wide with an equal height, but can be trained into a single trunk. It performs best in filtered sun or morning sun and afternoon shade. There is another species of this genus, *E. papyrifera*, that most taxonomist do not recognize, whereas most plantsmen do. This species is inferior in all respects to *E. chrysantha*, being less cold hardy, with leaves half the size of *E. chrysantha*, with smaller heads of only 25 to 35 flowers, far less fragrance, and more susceptibility to root rot. I can see some potential for *E. chrysantha* as a cool greenhouse plant in more northern areas, because of its long flowering period, fragrance, and lush foliage. After evaluating numerous selections of this species, we have given the name 'Winter Gold' to the best clone that we have found.

Softwood cuttings are our preferred method of propagation, with a 7 : 1 Dip 'N Grow<sup>®</sup> auxin solution, but one must take cuttings before summer temperatures get too high or when fall temperatures drop, since the large fleshy leaves tend to wilt readily and additional mist causes fungal problems and dropping of leaves. Basal sprouts will root in less than 2 weeks, but it is difficult to get an adequate number of these for wholesale production. Tip cuttings will take 8 to 10 weeks to root, but

one must constantly remove yellowing leaves from the mist bed. We have rooted hardwood cuttings taken in January, but our rooting percentages are not nearly as great. The Japanese have made numerous selections of *Edgeworthia* with orange and red flowers and variegated forms, but most of these are *E. papyrifera* and have not proven nearly as durable. Grafting onto *E. chrysantha* would probably increase vigor.

As an additional point of interest, we were visited by a group from the Beijing Botanical Garden in 2004, and they were rather impressed with the work that we were doing with this species. We were informed by them that the paper manufactured from the bark of this species is reserved for the most important governmental documents and that orchards of *Edgeworthia* are planted in China to harvest the bark to manufacture paper, which is reputed to be the finest paper in the world. Hence, the common name of paper bark bush. Zones 7(6b)–9.

***Osmanthus fragrans* 'Fudingzhu', fudingzhu fragrant tea olive.** This cultivar also masquerades under the name, 'Nanjing's Beauty', but 'Fudingzhu' is the correct cultivar name. Here is another one of those winter-flowering gems that flowers from September to April, with an intoxicating fragrance that can carry for hundreds of feet. However, the old saying, "One can smell it before one can see it," is no longer true. This cultivar flowers with great profusion, and it is much showier than the species, flowering in fascicles of 10 to 15 flowers each. Fudingzhu fragrant tea olive produces multiple buds per node in a stacked-like fashion, where one may observe as many as five or more buds stacked upon one another. This is the reason for its ability to repeat flowering throughout the winter. One can only appreciate this selection when seeing it in flower. It makes an impressive evergreen shrub of 2.4 to 3.7 m (8 to 12 ft).

In our location, propagation is from cuttings collected in May, while stems are still green and at the consistency to snap if bent. We wound and treat with a 5 : 1 Dip 'N Grow solution under mist. Some cuttings will root almost immediately, but others may take much longer. Weaning them off out from under mist will usually stimulate cuttings, which take longer to root. Zones 7b–9.

***Osmanthus fragrans* f. *aurantiacus*, orange flowering tea olive.** Of all of the selections of this species, this is probably the most spectacular in flower. Although it only flowers in the fall, it will literally stop traffic with its floral display. It has bright tangerine-orange flowers with exceptional fragrance that will literally encircle the branches of the current season's growth in October. Some years, we will get two flushes of flowers of about 10 days each spaced about 3 weeks apart. The one problem with this selection is that it will not usually flower until it reaches 1.2 to 1.5 m (4 to 5 ft) in height, usually as a 7-gal container or larger. However, 'Fudingzhu' will flower at a height of 7.6 cm (3 inches). Hence, to become a garden center commodity, one must plant a specimen on site, so that when it covers itself with bright orange flowers, the smaller nonflowering plants will literally walk out the door in customer's shopping carts.

Louisiana Nursery lists several cultivars, but having grown most of them, I see very little difference between them. In its native China, specimens may be seen as medium-sized trees to 9.1 m (30 ft) and more. The genus *Osmanthus* is practically free of insects and diseases. But they are not the easiest plants to propagate. To propagate, one can duplicate the procedure for 'Fudingzhu'. This selection is more cold hardy than the species, probably hardy through Zone 7, maybe even 6b.

***Illicium anisatum* 'Purple Haze', purple haze Japanese anise.** This selection was acquired from Mr. Yamaguchi of Japan. The new growth has a deep shining burgundy color for 2 to 3 weeks, then as the growth starts to harden off, it gradually fades to green. Each succeeding flush throughout the growing season has this same deep burgundy color. The original plant from which cuttings were taken has a conical upright form with an approximate height of 8 ft. Firm wood, wounded and treated with a 7 : 1 dilution of Dip 'N Grow, rooted approximately 80%. It performs best in filtered sun or morning sun and afternoon shade. There are several selections of this species with deep burgundy foliage that are found throughout Japan. They are all grafted and perform quite poorly, even in Japan. Since these are seedling selections, eventually one may be found that has enough vigor to be introduced. The flowers on 'Purple Haze' are the cream-white of the species, whereas the selections that retain the burgundy foliage all season will be anywhere from pink to apricot. Zones 7–9.

***Hydrangea macrophylla* 'Hatsushimo'.** This Japanese cultivar is typical of the Japanese practice of putting more emphasis on foliage than on flowering characteristics. This is true with many *Camellia* cultivars as well. This selection actually has more white than green in its variegated leaves, which resemble green splashes on a white background. It also has an amazingly good-sized lacecap flower head with white sterile florets that surround the light blue true flowers. It propagates easily from softwood cuttings, but due to its intense variegation, it is not as vigorous. Zones 7–10.

***Dichroa febrifuga* 'Yamaguchi Select', dichroa or evergreen hydrangea.** This is an unusual smallish shrub of only 76 cm (30 inches) or so, which is in the hydrangea family, *Hydrangeaceae*. It produces half-inch true flowers in clusters of 7.7 to 10 cm (3 to 4 inches) that will be pink in the absence of aluminum and deep blue with aluminum. Its greatest claim to fame is its electric blue berries, which are produced in the fall. I don't think there are any more brilliant blue fruit produced in the plant kingdom. This species must be grown in complete shade. Cuttings will root readily at almost any month of the year, but during the winter, bottom heat is helpful. Even when grown under deciduous trees, leaves will burn when exposed to winter sun; otherwise, it will remain mostly evergreen. Its vulnerability to cold will limit its distribution to Zones 7b to 10.

***Lespedeza liukuensis* 'Little Volcano', little volcano lespedeza.** On my first trip to Japan in 2000, I saw this species in full flower at the home of Mr. Akira Shibamichi of Shibamichi Hoten, who I consider a Japanese national treasure as one of the world's most outstanding plantsmen. Little volcano lespedeza displays an explosion of flowers with a color similar to *L. thunbergi* 'Gibraltar' on a cascading habit of 1.5 to 1.8 m (5 to 6 ft). Trying to be on my best behavior, I did not ask for a cutting. Upon visiting Mr. Shibamichi the following year, he had dug this plant and placed it in a large nursery container, and it was suffering from the move. Again, I restrained myself from petitioning for a cutting. Upon our visit in 2002, the plant was still in the container and was in a severe state of decline. I could not restrain myself any longer and asked Mr. Shibamichi if I could get a cutting. He literally ran over to his tool shed and retrieved a tool so that I could remove a basal branch. From this unrooted shoot, I was able to force two small sprouts from which I was able to get two cuttings. Mr. Shibamichi was somewhat dubious as to whether it

would survive in our colder climes, but my experience has been that even in single digits, the branches are killed back only a few inches from their tips. So, cold hardiness does not seem to be much of an issue. There are over 80 species and subspecies of *Lepedeza* listed in Flora of Japan, but this species is not listed unless it is identified under another name.

I shared this selection with Tony Avent of Plant Delights Nursery, and he e-mailed me that I should name it because of its superior performance. He suggested 'Little Volcano' because of its "eruption" of flowers in the fall. For us here in Zone 8, it begins to flower when 'Gibraltar' is finished in late October and flowers heavily throughout November. It appears that it will grow to around 1.5 to 1.8 m (5 to 6 ft) in height with an equal spread. It roots easily from softwood cuttings throughout most of the growing season. We overwinter them outside without protection and have had no losses. This species is native to the Ryuku Islands of Japan, which is equivalent to Zone 10, probably hardy in Zones 6–9 at least.

***Trachelospermum asiaticum* cultivars, Asiatic jasmine.** This genus has been a staple in many landscapes in the U.S.A. Deep South over the years, but the species "*asiaticum*" is more cold-hardy than "*jasminoides*." Selections of this species have been used mostly as groundcovers in shade to sun situations. Since it is a vine, it has much potential as a climber, especially with many new foliage forms and colors as well as when pink flowers are brought into the mix.

- **'Ougon-Nishiki'** is one of the more spectacular foliage forms of this genus. New growth is a brilliant brick-red that, as it matures, turns to bright yellow with irregular green margins. Probably the greatest potential for this plant is as a container subject, whether in a hanging basket or trained on a teepee or trellis. It has done well outside here into the mid-teens (°F) in a somewhat protected location. Its brilliant colors are at their best in strongly filtered sun light. It does well in the shade, but the colors are not nearly as intense. Flowers have yet to be observed on this cultivar.
- **'Pink Showers'** is the first pink-flowering form that I have seen in this genus. The star-like flowers are a good medium pink with incredible fragrance. Its first flush of blooms in May is stunning, followed through the growing season with continual flushes of fragrant flowers. This plant was introduced to Japan by Mr. Akira Shibamichi of Shibamichi Hoten, who is also responsible for the introduction of *Spiraea thunbergii* 'Fugino Pink' and *Ilex crenata* 'Sky Pencil'. This is definitely a new "breakthrough" in flower color for the genus and is sure to become a hit in U.S.A. Southern gardening circles. It would also be a great addition for greenhouses in Northern states. Its best attribute is its pink, fragrant flowers, which can be optimally displayed on a trellis, fence, or wall.

***Podocarpus lawrencei* 'Purple King', purple king mountain plum pine.** This Australian native does quite well in our Deep South heat and humidity. An ancient conifer, it more closely resembles yew or *Taxus*. It has fine 2-cm (0.8-inch) dark green needles resembling a hemlock with a resinous pine-like aroma. It makes a small- to medium-size rounded, spreading shrub. New growth is a light cream color, which sharply contrasts with its older dark green needles. It makes a fine

small shrub for the landscape, preferring light shade or morning sun and afternoon shade in the Southeast. It is an equally good subject for bonsai or containers. The species is extremely long lived with records of trees 160 years old in Australia and undocumented claims of up to 470 years. This cultivar takes on a bluish-purple cast after frost. Zones 6–9.

***Ardisia crispa*, hilo holly.** This is an awesome species with long, lance-shaped, dark, glossy-green leaves of 10 to 20 cm (4 to 8 inches). It flowers with a 3- to 12-flowered inflorescence on a pedicel of 8 to 13 cm (3 to 5 inches) with pale pink to white petals. Its greatest claim to fame is its vivid red berries of 0.6 to 1.0 cm (0.3 to 0.4 inch). There are cultivars, which also have cream-white to golden-yellow berries and others with crinkled and/or variegated leaves. This species is displayed extensively in Japan in the “koten engei” style where classical plants are trained and displayed in this Japanese form. It needs to be in a shade or part shade environment with adequate moisture. This species has not been put on noxious weed lists, as has its cousin *Ardisia crenata*. It has proven hardy well into Zone 7.

***Disporopsis* ‘Shina-no-tsuki’, shina-no-tsuki evergreen solomon’s seal.** This appears to be the only variegated evergreen Solomon’s seal, even though there are many variegated deciduous forms. This is an extremely nice plant with glossy golden-chartreuse leaves with a green margin, which makes a many-stemmed clump. For nurserymen, it is a dream to grow, because it roots easily from stem cuttings, with single-node cuttings rooting well. Since it roots at the node, a single-leaf cutting must be stuck with the node just below the soil line. In Japan it occupies a place of reverence in homes as a pot plant displayed in the “koten engei” style. It does well into Zone 7 (Zones 7–10) where it is quite persistent.

***Alpinia intermedia* ‘Sun Spice’, sun spice ginger.** This is an outstanding bright golden-yellow variegated ginger that was found in Japan and that only gets 40.6 to 45.7 cm (16 to 18 inches) in height. It is often confused with *A. zerumbet* ‘Variegata’ but differs in being somewhat more compact and more cold hardy. I have had it in the ground in our Zone 8 setting and it has come back dependably with temperatures in the mid teens. It actually does better in shade, and if put in too much sun, the leaves will burn. The Japanese even use it as a pot plant, and it makes a very handsome subject for container cultivation as a stand-alone or in combination with other plants. After growing this cultivar for 4 years, we have not had any flowers. It propagates quite readily from division, but we are also tissue culturing it. Zones 8–10.

***Hedychium densiflorum* ‘Assam Orange’, Assam orange ginger.** There are probably few plants that have been more misidentified than this species. Even in a web search, most references to this species are completely misnamed. Many cultivars that are attributed to this genus are actually *H. coccineum* or maybe a hybrid of *H. coccineum*. The inflorescence is a tight arrangement of small brilliant orange flowers that closely adhere to the main stalk, to a point that it resembles a brilliant “red hot poker” that has just been removed from the fire, much more so than a *Kniphofia*, which masquerades under this common name. The flowers are followed by brilliant red berries, which line the stem. This selection was found by the superintendent of the botanical garden of Katmandu, Nepal, and named for one of his children. It has extreme cold hardiness, possibly even to Zone 6b.

***Salvia leucantha* ‘Delilah’, Delilah Mexican sage.** As with so many plant



selections that we find in Japan, this one did not have a cultivar name. So we have named it 'Delilah', meaning "temptress" in Hebrew. I have seen several variegated forms of Mexican sage on the market, but they pale in significance beside this one. Well defined white margins with vivid bluish-purple flower spikes in the fall truly makes this selection a "temptress" in the garden. As with most other salvias, it roots in a matter of a few days. It needs full sun and good drainage for best performance in the garden. Since *S. leucantha* is not the most cold hardy of sages, it was feared that this variegated form would be even less so. However, it has overwintered here in Zone 8 in the ground with a -10 °C (14 °F) low temperature this past winter. Zones 8–10.

### SUMMARY

In summary, to compete with the "big box" nurseries, smaller nurseries like us must use our advantage of being able to explore for new plant material for our respective markets. This seems to be the only way that we can survive in the global economy, where big is usually presumed to be better.

---

## Growing Quality Trees for Southeastern Landscapes®

### Michael Marshall

Marshall Tree Farm Inc., 17350 SE 65th Street, Morriston, Florida 32668

### INTRODUCTION

Florida tree nurseries have experienced significant changes in production demands during the last decade. Factors leading to these changes include publication of the 2nd edition of the *Florida Grades and Standards for Nursery Plants*, increased demand, and increased buyer sophistication. The publication of the 2nd edition of the *Florida Grades and Standards for Nursery Plants* has had a tremendous effect on the level of quality that buyers are requesting and expecting. Simultaneously, there has been a large increase in demand due to seemingly endless development. This demand, while helping the industry in some ways, has also led to a large number of nursery expansions, and new large nurseries are entering the market. Increased buyer sophistication has meant that many architects and developers are more aware and much more specific about species, cultivars, and the production method they prefer when specifying trees. All of these changes have forced nurseries to change their business strategies in order to compete successfully.

### DEFINING QUALITY FIELD-GROWN TREES

Field growing of landscape trees was once the only method used to transplant large caliper trees into landscapes. Today, container and field production are both viable alternatives. Due to the increased popularity of container production of large trees during the last 20 years, field-grown tree nurseries have had to compete by marketing their product more effectively. Roots Plus Growers Association of Florida (RPG) was formed by a group of like-minded growers in the early 1990s to promote the importance of buying quality, hardened-off, field-grown trees. The association's mission is threefold: (1) to guarantee the consumer is buying a hardened-off, field-

selections that we find in Japan, this one did not have a cultivar name. So we have named it 'Delilah', meaning "temptress" in Hebrew. I have seen several variegated forms of Mexican sage on the market, but they pale in significance beside this one. Well defined white margins with vivid bluish-purple flower spikes in the fall truly makes this selection a "temptress" in the garden. As with most other salvias, it roots in a matter of a few days. It needs full sun and good drainage for best performance in the garden. Since *S. leucantha* is not the most cold hardy of sages, it was feared that this variegated form would be even less so. However, it has overwintered here in Zone 8 in the ground with a -10 °C (14 °F) low temperature this past winter. Zones 8–10.

### SUMMARY

In summary, to compete with the "big box" nurseries, smaller nurseries like us must use our advantage of being able to explore for new plant material for our respective markets. This seems to be the only way that we can survive in the global economy, where big is usually presumed to be better.

---

## Growing Quality Trees for Southeastern Landscapes®

### Michael Marshall

Marshall Tree Farm Inc., 17350 SE 65th Street, Morriston, Florida 32668

### INTRODUCTION

Florida tree nurseries have experienced significant changes in production demands during the last decade. Factors leading to these changes include publication of the 2nd edition of the *Florida Grades and Standards for Nursery Plants*, increased demand, and increased buyer sophistication. The publication of the 2nd edition of the *Florida Grades and Standards for Nursery Plants* has had a tremendous effect on the level of quality that buyers are requesting and expecting. Simultaneously, there has been a large increase in demand due to seemingly endless development. This demand, while helping the industry in some ways, has also led to a large number of nursery expansions, and new large nurseries are entering the market. Increased buyer sophistication has meant that many architects and developers are more aware and much more specific about species, cultivars, and the production method they prefer when specifying trees. All of these changes have forced nurseries to change their business strategies in order to compete successfully.

### DEFINING QUALITY FIELD-GROWN TREES

Field growing of landscape trees was once the only method used to transplant large caliper trees into landscapes. Today, container and field production are both viable alternatives. Due to the increased popularity of container production of large trees during the last 20 years, field-grown tree nurseries have had to compete by marketing their product more effectively. Roots Plus Growers Association of Florida (RPG) was formed by a group of like-minded growers in the early 1990s to promote the importance of buying quality, hardened-off, field-grown trees. The association's mission is threefold: (1) to guarantee the consumer is buying a hardened-off, field-

grown tree, (2) to share new ideas to continually improve tree quality, and (3) to sponsor research and educational programs. Hardening-off is the process of holding trees (curing) for a period of time (minimum of 3 weeks) after harvesting until new roots begin to regenerate. This may sound like a simple idea, but research has proven that hardened-off field-grown trees are a superior performer in terms of establishment times and irrigation requirements in the landscape. Roots Plus Growers' trees display a tag telling consumers to look for new roots growing through the burlap to ensure they are receiving a hardened-off tree.

## FLORIDA GRADES AND STANDARDS

Grades and standards for nursery plants were passed by the Florida Legislature in 1955. The 1st edition of *Florida Grades and Standards for Nursery Plants* (1965) was widely circulated but had minimal relevance or influence on the landscape tree market. The impetus for the 2nd edition was to improve the structural and aesthetic quality of trees. The 2nd edition had a tremendous impact on the landscape tree market and was immediately popular with architects, municipalities, and selected buyers. It has become, for all practical purposes, the universal tree specification throughout Florida. The *Florida Grades and Standards for Nursery Plants* provides a 10-step process that ends with all trees being graded in one of four grades: Florida Fancy, Florida #1, Florida #2, or a Cull. These grades are determined by looking at trunk structure, branch structure, canopy uniformity, root ball size, root quality, overall health, and many other factors.

## GROWING QUALITY TREES

Production protocol for growing quality trees can be divided into three major categories: tree selection and planting, maintenance and pruning, and harvesting and hardening-off.

**Tree Selection and Planting.** Tree growers have a unique challenge in selecting which species and cultivars of trees to produce. Growers must use long-term planning strategies for selecting species and cultivars today that may not be sold for 4 to 10 years depending on final production size. Often these decisions are made without real data on what trees will be specified and in what quantities at the time of sale. There is greater emphasis in Florida over the last 10 years on cultivars and less on seedlings. The latest, and probably most anticipated species to be cultivated is *Quercus virginiana*. Many growers throughout the Southeastern U.S.A. are developing cultivars of live oak as well as many other oaks that have previously not been propagated from rooted cuttings. Growers and buyers are increasingly faced with new choices of tree cultivars. Tree selection is a complicated decision that includes growth and production estimates as well as sales and marketing plans.

Decisions also must be made as to what size and type of liner to grow or purchase. An 11.4-liter, (3-gal) liner planted into the field is a common size for Florida growers. The most important factor in acquiring quality liners is to ensure they are vigorously growing, appropriately sized for their container, and that the root system is healthy but without deformities. There are many new container types specifically designed to reduce root deformities in both liner and finished size containers. Even after buying liners grown in root-manipulated containers it is important to correct any deformities such as kinked or circling roots that can lead to culls or poor quality

plants. Another important issue at planting time is planting depth in the field, as well as planting depth in the liner root ball. There has been much discussion in the tree industry in the last 2 to 3 years about the importance of root depth in long-term health and survival of trees. Many growers are making the effort to plant trees with the top-most root emerging from the trees at or near soil level. In some cases this can mean removal of several inches of soil from liners prior to planting.

**Maintenance and Pruning.** Proper maintenance involves many aspects of production integrating together to produce a high quality product. Maintenance problems at any step of the way can be critical to the long-term quality and viability of trees. As with production of any horticultural crop, proper irrigation and fertilization are important to maximizing growth and quality. Irrigation management involves not only selecting the right irrigation system but also scheduling and managing that system.

Fertilization management strategies vary from grower to grower; however, all would agree that a scheduled and managed fertilization program is essential to producing quality trees.

Root pruning is an essential maintenance tool for producing a quality root system on certain species. Research has shown that root pruning produces a root system that is more fibrous with smaller diameter roots. This technique is especially helpful on species that are more coarsely rooted such as oaks and is used much less frequently on species that are naturally more fibrous. This technique has been shown to decrease water stress in trees after harvesting, thereby increasing survivability. Root pruning strategies differ from nursery to nursery, but most nurseries use some form of root pruning at least the season prior to harvesting, while others root prune multiple years prior to harvesting. These strategies differ due both to the experience of the nurseries with past crops as well as to the differences in soil and environmental conditions from nursery to nursery.

Pruning and staking of trees is a critical element in developing a high quality crop. Trees are normally staked from the time of planting until trees reach a caliper large enough to support themselves [2.5–5.1 cm (1–2 inches)]. Staking has sometimes been linked with slowing tree growth or weakening trees; however, on many species it has proven to be an essential tool for producing trees with straight trunks, which almost all buyers demand.

An important component of the 2nd edition of *Grades and Standards for Nursery Plants* is to produce large maturing shade trees with one dominant trunk. This component of the grades and standards is the first step in a 10-step process and for many buyers has become the most recognizable characteristic of a quality tree. Most growers have accepted this standard and have adjusted their pruning protocol accordingly.

Pruning for quality trees can be divided into two different types: (1) structural pruning in the canopy and (2) lower temporary branch pruning on the trunk. Structural pruning is used to guide the tree over the course of years to produce a tree with a dominant trunk and many well-attached branches that together create a well-shaped canopy that is both structurally and aesthetically appealing. This can be accomplished subtly over time by using arboricultural techniques such as branch subordination and occasionally branch removal. Lower temporary branch pruning refers to the pruning of branches from what will eventually be the tree's

cleared trunk. In the past many growers have simply removed all limbs from the trunk area as early as possible in production. This method has been shown to increase tree height without an increase in caliper, leading to frequent topping and long-term staking. Research has shown that leaving lower branches on the trunk as long as possible helps to build trunk caliper and possibly acts to regulate top growth. Lower branches need to be managed and pruned so as not to become excessively large or in the way during production. Both structural pruning in the canopy and lower temporary branch pruning are essential once or twice per year depending upon species, age of the crop, and climate.

**Harvesting and Hardening-Off.** Harvesting protocols for field-grown trees can vary from nursery to nursery based on environmental conditions. Many growers find it ideal to harvest some species only during the dormant season, while other species can be harvested almost year round. Harvesting techniques vary with different sizes of trees harvested. The most common sizes harvested in Florida would be a 71-cm (28-inch) root ball up to a 229-cm (90-inch) root ball. Some nurseries harvest trees and transport them to holding areas, while others harvest trees and leave the trees in the production fields until shipping. Quality field-grown trees should be hardened-off in the nursery prior to shipping and transplanting. Hardening-off requires holding trees after harvesting under optimum irrigation until roots have begun regenerating.

## RESEARCH AND EDUCATION

Many techniques and management strategies used in nursery production have come from research and experiments at many nurseries over a period of years. As with much of horticultural production these techniques are learned and refined over many years of trial and error. We do however have an obligation to the industry to continue working at our farms and with research facilities to refine current practices as well as discover new time- and labor-saving techniques. The Florida Nursery, Grower and Landscape Association is working with the University of Florida to host the Great Southern Tree Conference (GSTC). This annual conference started in 2000 and has the support of the tree industry with partner businesses contributing approximately \$80,000 per year. Partner business contributions are used to develop and maintain a demonstration site with experiments that attendees can see and experience each year they attend. The GSTC attracted over 400 attendees in 2004 making this an excellent venue not just for research but also for education of the green industry.

Conferences such as IPPS and GSTC along with the commitment of individual nurseries to experiment and share their experiences are an obligation we all have to the green industry. As we continue to grow and select trees to meet the specifications and needs of tomorrow we must continue to be an active part of the research and education process that is helping to shape those needs. Gone are the days when tree farms simply grew trees and buyers came knocking on the door; today's tree market is much more sophisticated and competitive.

## Grafting Deciduous Plants: Before and Aftercare<sup>©</sup>

Brian L. Upchurch

Highland Creek Nursery, 269 Drake Farm Road, Fletcher, North Carolina 28732

### INTRODUCTION

Discussions about grafting ornamental plants often concern only the techniques or the mechanics of the grafting process. The focus usually involves the type of graft used or perhaps the materials used. The grafting process itself cannot be overlooked or minimized — it is essential in every aspect to the success of the graft. Other equally important factors cannot be ignored. The informed selection of the proper rootstock, the preparation of the rootstock prior to grafting, the collection and care of scion material, and the aftercare of the completed graft are also extremely critical to the success of the grafter. All components of the grafting equation must be addressed to ensure the end result will be successful. In this paper, I wish to place the emphasis on the steps leading up to grafting and the aftercare of the graft. The focus here will also be on winter or dormant bench grafting.

### ROOTSTOCK

The first concern in the grafting process is the rootstock or understock. First and foremost, the rootstock and scion must be compatible. If they are not compatible, the graft union will fail, if not immediately then at some point early in the plant's life. Even when they are compatible, some choices are better than others. The wrong rootstock may tend to sucker, outgrow, or undergrow the scion. This can lead to both aesthetic and functional long-term problems with the plant. It is critical to choose the best possible rootstock, and choosing the proper rootstock will come from both experience and communicating with other grafters.

The rootstock must also be vigorous and healthy to ensure grafting success. I have found that an established rootstock will produce appreciably better results than those that have been bare-rooted or transplanted just prior to grafting. In my nursery, I pot-up seedlings in February or March prior to grafting them late in the same year or, more likely, the first of the following year. The seedlings may be bare-root or small plugs. With experience, I have learned what size to order from my seedling vendors to reach the optimum size during the growing season for subsequent grafting. For example, a 1-year-old, 0.3-cm ( $1/8$ -inch) caliper *Acer palmatum* seedling in a small plug will grow during the season to 0.6–1.0-cm ( $1/4$ – $3/8$ -inch) caliper or better for grafting the following winter.

Seedlings are usually potted into 7.3 × 7.3 × 14 cm ( $2^{7/8}$  ×  $2^{7/8}$  ×  $5^{1/2}$  inch) Anderson tree-bands. This gives me the best use of space during the growing season in the nursery and then in the propagation house during the grafting season. It is also a comfortable size container to hold and work with while grafting each plant. Occasionally, I use the larger 9.2 × 9.2 × 15.2 cm ( $3^{5/8}$  ×  $3^{5/8}$  × 6 inch) Anderson pot or a trade gallon for more aggressive rootstocks such as *Ulmus alata* and *Nyssa sylvatica* or those with heavy caliper such as *Aesculus species* or *Magnolia kobus*.

The potting mix is essentially the same mix I use throughout the nursery for most crops, grafted or otherwise. It consists primarily of composted pine bark. This could easily vary depending on the location of the nursery, available substrates, and the

needs of the plant in question. The mix should be based on the needs of the rootstock with regards to moisture retention, drainage, and other physical properties important to plant growth. No changes are necessary simply because the plant will be used as a rootstock rather than a finished plant.

I pot up the rootstock in March and place them in a cold frame where they will reside for 8–9 months. The cold frame is initially covered with white poly for overwintering, although this may not be necessary depending on location and plant variety. Much of my rootstock comes from the Pacific Northwest, and it tends to be further ahead with regards to breaking dormancy than comparable plants in my Zone 6 location. The covered cold frame allows me to mitigate late freezes, frosts, and wind on the new seedlings. The cold frame will be uncovered along with the other cold frames in the nursery in early May, once the threat of frost has passed. I then cover most of the rootstocks with 30%–40% shade for the remainder of the active growing season. I believe that some shade reduces stress on the young plants. It also provides a physical barrier against some insects (Japanese beetles) and hail and reduces wind exposure.

The rootstock is basically treated like any other crop in the nursery. It is watered and fertilized based on the requirements of the plant and container size. Pruning is minimal. However, some plants will need to be limbed up to keep the lower trunk clear for later grafting.

One significant concern with plants grown for rootstocks is the use of herbicides. The consensus is that pre-emergent herbicides should be avoided on understock plants. Before I knew better, I used pre-emergent herbicides for a year or so early in my grafting career with no adverse affects that I could readily see. I have since ceased using pre-emergent herbicides on rootstock, but often wonder if this omission is warranted. As a rule, I have few problems with weeds in the tree band crops; probably due to clean bark substrates and the close proximity of the plants in flats and resulting shade. However, with 1-gal crops weeds can be an issue. Rootstocks not grafted the 1st year and held over may have significant weed problems. Weeds, of course, will have the same detrimental effect on rootstock crops as on any other.

In September of the crop year, I remove the shade cloth from the cold frame. As the nights become cooler and October arrives, I reduce irrigation to encourage dormancy.

With somewhat dryer media, shorter days, and cool nights, the plants will shut down for the season. The rootstock is now exposed to the normal temperature fluctuations of fall in the southeast. By early November we have had several frosts, and the days are significantly cooler as well. I then began working to clean up the rootstock as needed. Any weeds present are removed as well as leaf litter.

Around the first of December, I begin to move the rootstock into the propagation houses. I try to spread this task out over the entire month of December. When I begin grafting at the end of December to the first of January, the first rootstock brought in will have been in the prop house 3 to 4 weeks. The last of the rootstock brought in towards the end of December will be grafted in February. The goal is to graft plants that have been in the propagation house environment 3 to 5 weeks prior to grafting. I have made exceptions to this if the weather in December is exceptionally cold for more than a day or so. In this case, I will move all of the rootstock into the heated propagation house.

The environment in the propagation house is very important to the success of winter grafting. I keep the thermostat set at 2–3 °C (36–38 °F) to maintain tempera-



tures above freezing at night. The ventilation fan is set to run when the daytime temperatures in the propagation houses reach roughly 16–18 °C (60–65 °F). No shade is used during this period on the propagation houses. Very importantly, the rootstock is not irrigated at all during the time it is in the propagation houses prior to and for sometime after grafting. This drying out process is especially important on species that tend to “bleed” when cut for grafting. *Acer palmatum* is particularly prone to this. Too much bleeding at the graft wound can “drown” the graft union and may cause the graft to fail.

Given that there is no foliage present at this time and the exhaust fans run less due to cooler temperatures, the rootstock will take 3 to 4 weeks to dry. “How dry” is often a question. The answer comes with experience. I want the rootstock to be free of any excess water and feel light when lifting up the pots, but not so dry that the bark media cannot be re-hydrated. The upper portion of the plant itself should remain green and pliable without showing signs of dehydration or hardening wood. After 3 to 4 weeks in the propagation house, new roots will begin to grow. This is the optimum time to graft.

## SCIIONS

The next process in grafting is collecting scion material. The stock plants should be healthy and vigorous. Scion material collected from older plants in landscapes or arboreta will often be inferior to those collected from well-maintained stock plants. Poor scion material may result in a failed graft or perhaps a graft that is alive but simply doesn't thrive. It may or may not recover. Scions should be cut from the most recent season's growth; the larger the material, the better. This juvenile growth will offer the best results. Scions should be collected from the most recent season's flush. Larger scion material will produce a much heavier flush of new growth on the fresh graft. The larger scion will also accommodate a larger rootstock, resulting in a heavier flush.

The scions should be dormant. This will enable the graft union to heal before the scion breaks dormancy and begins to leaf out. If the scion material breaks dormancy before the union has healed, the scion will not have nutrients and moisture from the root system to sustain the emerging foliage.

Scions should be cut from stock plants when the temperature is above freezing. It should not be allowed to dry out. Scion material can be stored for several weeks if necessary in a cooler. The primary concern is that the wood does not dry out. Care must be taken to keep scions damp, but not too wet as to cause rot and/or mold problems. It is best to collect scion material as needed, but more often than not it is necessary to store it for some length of time. The sooner it can be grafted, the better. I will often treat the scions with a fungicide and horticultural oil, especially if they have been sent to me or collected from an unknown or dubious source.

One of the most common problems I encounter with scions sent to me from plant hobbyists, arboreta, and gardeners is poor scion material. Scions from older plants tend to be thin and inferior to those collected from well-maintained stock plants. Poor scion material will always affect the quality of the graft, if it is successful at all. In addition, the accuracy of the true cultivar name is often in doubt, especially from nonprofessional sources. Keep this in mind until the identity can be made with certainty as the plant grows through a season or so. It is best to maintain your own stock plants to ensure the quality and identity of your grafts.

## THE GRAFT

The intent of this paper is to explain the steps leading up to grafting and then the aftercare of the completed graft, rather than the actual techniques of grafting per se. The type of graft and materials used will depend on the individual's preferences and skill, as well as the type of plant to be grafted.

## AFTERCARE

When the actual graft is completed; the plants are kept in the propagation house. Depending on when the grafts were completed and the plant type, the union will take anywhere from 3 to 6 weeks to heal. Early January grafts will take longer than those completed in late February. With longer days and relatively warmer temperatures in the propagation house, the scions will begin to grow.

As the buds begin to swell, the grafts are watered well. This will likely take several irrigation cycles to get the media moistened properly. Once the media is well moistened, subsequent irrigation is applied as needed. I then apply a controlled-release fertilizer (3 to 4 month) at  $\frac{1}{2}$  the normal rate. This will feed the graft without pushing them too quickly. They will be fertilized again when potted up later.

The propagator will need to watch for fungal problems, aphids, and slugs during the period between bud swell and initial watering and the time the grafts are moved out of the propagation house. The grafts in the propagation house will generally leaf out earlier than similar plants in cold frames or in the landscape, so care must be taken to avoid spring frosts. Heat and/or power failure at this time can be devastating.

At this time, I spread out the grafted plants as much as possible within the confines of the propagation house. I also remove any suckers that are growing below the graft and any dead plants. Removing suckers will allow for more growth in the scion and also improve air circulation.

Once the new flush has hardened off and frost is no longer an issue, the grafts are ready to be removed from the propagation house. At my Zone 6 location in western North Carolina, this is around the 1st or 2nd week of May. The grafts are ready to either be shifted up or shipped to your customers to continue growing for the remainder of the season.

## CONCLUSION

The mechanics or techniques of grafting (a sharp knife; a clean, even cut; the right type of graft; and a good, tight wrap) woody ornamental plants are essential for grafting success. Equally important is the before and aftercare. The proper rootstock, proper preparation of the rootstock prior to grafting, quality scion material, and the proper aftercare of the completed graft will contribute significantly to the success of the grafting process. To be successful, the propagator must understand each step in the process of grafting. Each step is like a link in a chain. If there are problems in one step of the process, the "weak link" may cause the process or chain to fail. However, if the propagator is diligent with each step, successful grafting will be the result.

## Impact of Nitrogen Concentration on Stock Plant Yield and Cutting Performance of 'Purple Small Leaf' and 'Raspberry Ice' Bougainvilleas<sup>®</sup>

Christopher B. Cervený, James L. Gibson, and James E. Barrett

University of Florida, Department of Environmental Horticulture, Gainesville, Florida 32611

Effects of nitrogen (N) concentration on yield, cutting quality, and rooting performance were investigated to establish a nitrogen-based fertility program for bougainvillea stock plants. Stock plants of 'Raspberry Ice' and 'Purple Small Leaf' were fertigated with N at concentrations of 100, 200, or 300 mg·L<sup>-1</sup>. Overall 'Purple Small Leaf' stock plants produced more and longer cuttings than 'Raspberry Ice', however rooting performance was better with 'Raspberry Ice'. The greatest cutting yields were achieved with N at 200 mg·L<sup>-1</sup>, and shorter cuttings with smaller leaf areas occurred when stock plants were fertilized with N at 100 mg·L<sup>-1</sup>. Cutting diameter was not influenced by N concentration. Undesirable leachate nitrate nitrogen values were observed from stock plants fertilized with N at 300 mg·L<sup>-1</sup> after cuttings were harvested 14 and 22 weeks after potting. Based on these results, stock plants of 'Raspberry Ice' and 'Purple Small Leaf' should be fertilized with N at 100 to 200 mg·L<sup>-1</sup>.

### INTRODUCTION

Because the popularity of gardening with tropical annuals, perennials, and vines has grown in the U.S., there has been a considerable increase in production and sales of tropical plants over the past several years (Bowden, 2004). Shortages and poor quality cuttings supplied by domestic propagation firms has become a concern for growers wishing to produce tropical plants for the spring season. Propagators have expressed a need for standardizing production practices to maximize cutting yield and subsequent adventitious root formation in propagules; however, little is published on how to effectively manage tropical stock plants (Dole and Wilkins, 1999; Hartmann et al., 2002).

A tropical species that has potential to be more widely used by gardeners is bougainvillea (*Bougainvillea glabra*). This multi-use plant grows best in U.S. landscapes during summer months with attractive bracts displayed during short-days. Unfortunately because of its warm temperature production requirements and difficulty in propagation, commercial availability is limited (Czekalski, 1989). Bougainvillea is generally propagated from stem cuttings or air-layering, but often fail to produce roots, and rooting percentage is low, even during the cultivated seasons (Chakraverty, 1970). The root systems are also known to be extremely fine and fragile. Bougainvillea root best from semihardwood to hardwood cuttings depending on temperature (Schoellhorn and Alvarez, 2002), location (Auld, 1987), and time of year (Chakraverty, 1970). These plants have been documented to benefit from bottom heat with rooting substrate temperatures of 30 °C (86 °F) (Singh et al., 1976).

Nitrogen (N) concentration is crucial in cuttings as it is important for nucleic acid and protein synthesis in plant tissue (Hartmann et al., 2002). When considering

the role N has in these metabolic processes such as protein synthesis, one could strongly argue its importance in root initiation (Blazich, 1988). Nitrogen concentration also affects cutting yield of stock plants and rooting performance of cuttings. While excessive N may negatively affect cutting propagation (McAvoy, 1995), heavy fertilization in some tropical plants such as bougainvillea, has been observed to inhibit flowering and promote growth (Schoellhorn, 2002).

Although optimum nutrient levels of tropical stock plants remains unclear, it is crucial that propagules come from a nutritionally healthy source (Hartmann et al., 2002). Limited research has been conducted in the management of bougainvillea stock plants for purposes of maximizing quantity and quality of cuttings suitable for propagation. Our objective was to evaluate the impact of three nitrogen concentrations on stock plant yield and cutting performance of *Bougainvillea* 'Purple Small Leaf' and *B. × buttiana* 'Raspberry Ice'.

### MATERIALS AND METHODS:

Rooted stem cuttings of *B. × buttiana* 'Raspberry Ice' and *B.* 'Purple Small Leaf' were transplanted, two per pot, into 2.8-L (0.74-gal) (15.2-cm [6-inch diameter]) round plastic containers on 15 Oct. 2004. The root substrate was Fafard 2 (Fafard, Anderson, South Carolina), which contained 6.5 sphagnum peat : 2 perlite : 1.5 vermiculite (by volume). A continual liquid fertilization program was initiated on 8 Nov., with N concentration levels at 100, 200, or 300 mg·L<sup>-1</sup>. Phosphorous (P), potassium (K), calcium (Ca), and magnesium (Mg) were held constant at 20, 200, 100, and 50 mg·L<sup>-1</sup>, respectively. Micronutrients were provided using soluble trace elements in solution (S.T.E.M., J.R. Peters, Inc., Allentown, Pennsylvania) at a rate of 6.78 mg·L<sup>-1</sup>. Supplemental iron was applied using FeEDTA (Sequestrene) at a rate of 1.76 mg·L<sup>-1</sup>. Ammoniacal-nitrogen was 6% to 35% of the total nitrogen in all treatments. Plants were fertigated by a submersible pump drip irrigation system. The experiment was a randomized complete block design with six single-plant replications of each of three treatments. Stock plants were grown in a greenhouse under natural photoperiod and irradiance with day/night temperatures of 21/18 °C (70/65 °F). Stock plants were pinched on 8 Nov. and 6 Dec. to develop a canopy for harvesting cuttings.

Leachate samples were initially collected 4 weeks after potting (WAP) and bi-weekly thereafter until 28 WAP via a modified Virginia Tech Extraction Method (VTEM) (Wright, 1986) to determine pH, electrical conductivity (EC), and nitrate nitrogen (NO<sub>3</sub>-N). Distilled water (85 ml) was applied to the substrate surface to displace 50 ml of leachate. Leachate solutions were analyzed for pH (pHep pH meter; Hanna Instruments, Woonsocket, Rhode Island), EC (DiST WP4 EC meter; Hanna Instruments), and NO<sub>3</sub>-N (Horiba Compact Ion Meter C-141 Spectrum Technologies, Inc., Plainfield, Illinois).

Stock plants were maintained in Milton, Florida, and harvested 14, 19, 22, 26, 31, and 36 WAP on 17 Jan. (H1), 22 Feb. (H2), 15 March (H3), 11 April (H4), 16 May (H5), and 13 June (H6). Harvesting protocols consisted of removing the shoot tip 0.5 cm above the first recently mature leaf node, and excised thereafter 1 cm below the fourth node.

The number of cuttings was recorded at each harvest, and three cuttings per replicate from each treatment were selected randomly 14, 22, and 31 WAP to measure stem base diameter (mm) and shoot length (cm). Cutting leaf area was also measured with a LI-COR LI-3100 portable area meter (LI-COR, Lincoln, Nebraska).

Cuttings harvested 19, 26, and 36 WAP were packaged in moist towels, inserted into perforated plastic bags, and box shipped to Gainesville, Florida, for propagation.

Unless otherwise noted, basal portions of cuttings (1 cm) were inserted into indole-3-butyric acid, potassium salt (K-IBA) at 3,000 mg·L<sup>-1</sup> for 3-sec then inserted into 3.3 × 8.8 × 6 cm (1.3 × 3.5 × 2.4 inch) 6-cell containers in a substrate consisting of 4 perlite : 1 vermiculite (v/v) and placed under intermittent mist. Cuttings were maintained under natural photoperiod and irradiance with day/night temperatures of 20/18 °C (68/64 °F) and misted daily for 10-sec every 30 min (7:00 AM–7:30 PM). Bottom heat was provided at 24 °C (75 °F). The experimental design was a completely randomized design with three N treatments with three replications per treatment and six sub-samples per replication. Exceptions to the study included using a rooting substrate of 1 sphagnum peat : 1 perlite (v/v) for H2 and 100% perlite for H4.

Adventitious roots ≥ 1.0 mm in length were evaluated 4 and 6 weeks after sticking (WAS). The numbers of primary and secondary roots were counted and recorded 4 WAS. Cuttings were evaluated for rooting quality based on a 0 to 5 scale 4 and 6 WAS: 0 = no roots; 1 = minimal rooting; 2 = minimal, uneven rooting; 3 = moderate, uneven rooting; 4 = moderate, uniform rooting; 5 = well-developed rooting. Root quality values were reassigned relative to each cutting at each evaluation date.

Data were subjected to analysis of variance using general linear model procedures (SAS Inst., Cary, North Carolina). Means were separated by least significant differences (LSD) at  $P \leq 0.05$ .

## RESULTS

**Leachate Analysis.** As N concentration increased, leachate pH decreased for both cultivars. Fertilizing stock plants of 'Raspberry Ice' with N at 100, 200, or 300 mg·L<sup>-1</sup> produced pH values of 6.6, 6.3, and 5.8, respectively, while fertilizing 'Purple Small Leaf' with N at 100, 200, or 300 mg·L<sup>-1</sup> produced pH values of 6.8, 6.3, and 5.9, respectively. Bougainvillea performed best at pH values of 5.5 to 6.0 (Schoellhorn, 2002). In our study pH values ≥ 6.0 may be attributed to the low percentage of NH<sub>4</sub>-N in the fertilizer treatment or limestone activation in the root substrate.

There was a significant treatment by week interaction for leachate EC for both cultivars. 'Raspberry Ice' stock plant EC values peaked for concentrations of N at 200 and 300 mg·L<sup>-1</sup> following harvests 14 and 22 WAP. A similar trend occurred for N at 300 mg·L<sup>-1</sup> with 'Purple Small Leaf'. Greater differences amongst N concentrations occurred with 'Raspberry Ice' than 'Purple Small Leaf' (data not shown). Similarly, leachate NO<sub>3</sub>-N levels increased following the second pinch and after a cutting harvest H1 (14 WAP) and H2 (19 WAP). These differences were greater with N at 300 mg·L<sup>-1</sup>; significant differences in treatment were less common when stock plants were fertilized with 200 mg·L<sup>-1</sup> and almost nonexistent when fertilized with 100 mg·L<sup>-1</sup>. Leachate NO<sub>3</sub>-N levels were not significantly different between cultivars.

**Cutting Quantity.** For H1 the cultivar × treatment interaction was not significant, therefore only the main effects are presented. Stock plants of 'Purple Small-Leaf' (6.3) produced 150% more cuttings than 'Raspberry Ice' (4.1) (LSD = 1.0, n = 18). Stock plants produced 147% more cuttings when fertilized with N at 200 mg·L<sup>-1</sup> N than with N at 100 mg·L<sup>-1</sup> (data not shown). For H2, the cultivar × treatment interac-

tion was significant for stock plant yield. 'Purple Small-Leaf' fertilized with N at 200 mg·L<sup>-1</sup> or 300 mg·L<sup>-1</sup> produced 162% more cuttings than when fertilized with N at 100 mg·L<sup>-1</sup> (Table 1). 'Raspberry Ice' produced six cuttings per plant, regardless of N concentration. For H3 the cultivar × treatment interaction was not significant with 'Purple Small Leaf' stock plants producing 195% more cuttings than 'Raspberry Ice' (9.1 vs. 4.7) (LSD = 1.5, n = 18). When fertilized with N at 200 mg·L<sup>-1</sup>, stock plants of bougainvillea produced 8.1 cuttings per plant, which was 142% more than when fertilized with N at 100 mg mg·L<sup>-1</sup>, which yielded 5.7 (LSD = 1.9, n = 18). For H4, the cultivar × treatment interaction was not significant. 'Purple Small Leaf' stock plants produced 16.3 cuttings, while 'Raspberry Ice' produced 5.6 (LSD = 2.1, n = 18). Stock plants produced 143% more cuttings at 200 or 300 mg·L<sup>-1</sup> when compared to 100 mg·L<sup>-1</sup> (data not shown). For H5 the treatment × cultivar interaction was significant for yield. For 'Raspberry Ice' no significant differences in treatment existed with 7.7 cuttings produced per plant. When 'Purple Small Leaf' was fertilized with 200 mg·L<sup>-1</sup>, 131% to 137% more cuttings were generated than with the 100 or 300 mg·L<sup>-1</sup> treatments, respectively (Table 1). For H6 the treatment × cultivar interaction was significant. When 'Raspberry Ice' was fertilized with N at 300 mg·L<sup>-1</sup>, 139% more cuttings were produced than when fertilized with N at 100 mg·L<sup>-1</sup> (data not shown). Stock plants of 'Purple Small Leaf' when fertilized with N at 200 mg·L<sup>-1</sup> or 300 mg·L<sup>-1</sup> yielded at least 180% more cuttings than when fertilized with N at 100 mg·L<sup>-1</sup> (Table 1).

**Table 1.** Effect of N concentration on cutting yield of 'Purple Small Leaf' bougainvillea harvested 14 (H1), 19 (H2), 22 (H3), 26 (H4), 31 (H5), and 37 (H6) weeks after potting.

N conc. (mg·L <sup>-1</sup> )	Harvest					
	H1	H2	H3	H4	H5	H6
100	5.50	7.83	7.83	12.83	24.33	25.00
200	7.67	12.67	10.33	18.67	31.83	45.00
300	5.83	13.67	9.16	15.50	23.17	46.67
Significance <sup>z</sup>	*	*	NS	NS	*	*
LSD	2.64	3.62	–	–	6.58	14.22

<sup>z</sup> \*, Significance at  $P \leq 0.05$ .

**Cutting Quality.** Only the first harvest was significantly different in basal stem diameter, with 'Purple Small Leaf' having a diameter of 1.9 mm, while 'Raspberry Ice' had a diameter of 2.2 mm (LSD = 0.02 n = 18). For H1 stock plants fertigated with N at 100 mg·L<sup>-1</sup> produced 16% shorter cuttings than cuttings generated from stock plants fertigated with N at 200 or 300 mg·L<sup>-1</sup> (Table 2). The treatment × cultivar interaction was significant for leaf area. Cuttings harvested from stock plants of 'Raspberry Ice' had a leaf area of 36.1 cm<sup>2</sup> and was not statistically different amongst N concentrations. When stock plants of 'Purple Small Leaf' were fertilized with N at 200 or 300 mg·L<sup>-1</sup>, leaf area was significantly greater, 27.5 or 31.4 cm<sup>2</sup>, respectively, than 100 mg·L<sup>-1</sup> (21.4 cm<sup>2</sup>) (LSD = 5.19 n = 6). For H3, 'Purple Small-Leaf' produced 16% longer stems than 'Raspberry Ice' (8.82 vs. 7.4 cm) (LSD = 0.87,

**Table 2.** Effect of N concentration on cutting length (cm) harvested 14 (H1), 22 (H3), 31 (H5) weeks after potting.

N conc. (mg·L <sup>-1</sup> )	Harvest		
	H1	H3	H5
100	5.56	7.21	6.79
200	6.58	8.29	7.33
300	6.95	8.90	7.83
Significance <sup>z</sup>	*	*	NS
LSD	0.82	1.09	—

<sup>z</sup> \*, Significance at  $P \leq 0.05$ .

**Table 3.** Rooting performance values four weeks after sticking from stock plants of bougainvillea for cuttings harvested 37 weeks after potting (H6).

	Survival (%)	Root quality rating	Primary roots (no.)	Lateral roots (no.)
'Raspberry Ice'	94	2.8	3.5	10.7
'Purple Small Leaf'	72	1.4	0.4	1.7
Significance <sup>z</sup>	*	*	*	*
LSD	17	3.2	1.4	3.2

<sup>z</sup> \*, Significance at  $P \leq 0.05$ .

$n = 18$ ). Stock plants fertilized with N at 300 mg·L<sup>-1</sup> produced 19% longer cuttings than 100 mg·L<sup>-1</sup> (Table 2). No significant differences in leaf area were observed between cultivars or amongst treatments with a mean of 34.4 cm<sup>2</sup>. For H5, stock plants produced shoots 7.3 cm long (Table 2). 'Purple Small Leaf' (28.8 cm<sup>2</sup>) had a larger leaf area than 'Raspberry Ice' (23.7 cm<sup>2</sup>) (LSD = 2.98,  $n = 18$ ).

**Rooting Performance.** For H2, no significant differences at four or six WAS were detected among N concentrations or between cultivars for percentage survival and root quality rating. At 4 WAS there were 13.8 lateral roots on cuttings harvested from stock plants fertilized at 100 mg·L<sup>-1</sup>, when compared to 3.7 or 2.7 lateral roots on cuttings from 200 or 300 mg·L<sup>-1</sup>, respectively (LSD = 6.7  $n = 6$ ). For H4, the cultivar × treatment interaction for number of roots was not significant, however 'Raspberry Ice' produced 250% more primary roots and 460% more lateral roots than 'Purple Small Leaf' (data not shown). Nitrogen concentration had no influence on primary or lateral root number. There was a cultivar × treatment interaction for cutting percent survival. For 'Raspberry Ice', no differences were measured, however 'Purple Small Leaf' produced cuttings that survived better with 100 mg·L<sup>-1</sup> (17%) than with 300 mg·L<sup>-1</sup> (0%). The highest percentage occurred with 200 mg·L<sup>-1</sup> (39%) (LSD = 0.13,  $n = 3$ ). Cuttings evaluated 6 WAS from plants fertilized with N at 300 mg·L<sup>-1</sup> had higher survival percentage (61%) than those fertilized with 100 mg·L<sup>-1</sup> (33%) (LSD = 0.21,  $n = 6$ ). For H6, the root quality rating 4 WAS higher with N at 200 mg·L<sup>-1</sup> (2.6) than 100 (2.0) or 300 mg·L<sup>-1</sup> (1.8) (LSD = 0.52,  $n = 6$ ). A similar trend occurred with number of lateral roots: 9.3, 3.8, 4.7, for 200, 100, and 300 mg·L<sup>-1</sup>, respectively (LSD = 3.96  $n = 6$ ). Percentage survival was higher at 200 mg·L<sup>-1</sup> than 100 mg·L<sup>-1</sup> (data not shown). Percent survival and root quality rating was higher,



and number of roots was greater for 'Raspberry Ice' when compared to 'Purple Small Leaf' (Table 3). Rooted cutting quality ratings at 6 WAS were better at 100 (3.14) or 200 mg·L<sup>-1</sup> (3.43) than 300 mg·L<sup>-1</sup> (2.40) (LSD = 0.69, n = 6). Similar to 4 WAS, cuttings from stock plants of 'Raspberry Ice' demonstrated higher root quality ratings than cuttings of 'Purple Small Leaf' 6 WAS (4.20 vs. 1.78) (LSD = 0.65, n = 9).

## DISCUSSION

While 'Purple Small Leaf' stock plants produced more cuttings at each harvest than the variegated cultivar Raspberry Ice, rooting performance was lower in this predominantly green-leaved cultivar. In order to improve cutting performance, stock plants of 'Purple Small Leaf' should be fertilized at 100 mg·L<sup>-1</sup> during the first few harvest dates, then increased to 200 mg·L<sup>-1</sup> to improve root number and quality as stock plants age.

Propagators of tropical plants need to adopt a nutrient program that produces the maximum quantity of high quality cuttings so that growers can profit from the specialized cultivation of stock plants. Relating yield, quality, and rooting performance of cuttings from stock plants fertilized at different N concentrations was a means of achieving this goal. Overall, stock plants of bougainvillea had the greatest yield and optimal cutting performance with N at 100 to 200 mg·L<sup>-1</sup>. Fertilizing with 300 mg N per L did not enhance yield and had higher, undesirable leachate nitrogen levels compared to 200 mg N per L, after cuttings were harvested 14 and 22 WAP.

Future studies will investigate the impact of nitrogen concentration on cutting quantity and quality during warm/high irradiance and cool/low irradiance periods of the year using 'Raspberry Ice' and 'Purple Small Leaf'.

**Acknowledgments.** The authors thank Shannon Crowley, Dawn Taylor, Mariah Williams, and Jude Groninger for their technical support. Appreciation is given to Hatchett Creek Farms, Gainesville, Fla. for the rooted liners and to the Fred C. Gloeckner Foundation for grant support.

## LITERATURE CITED

- Auld, R.E. 1987. The basics of propagating Bougainvillea. Comb. Proc. Intl. Plant Prop. Soc. 36:211-213.
- Blazich, F.A. 1988. Mineral nutrition and adventitious rooting, p. 61-69. In: T. Davis, et al. (eds.). Adventitious root formation in cuttings. Dioscorides Press, Portland, Oregon.
- Bowden, R. 2004. Growing tropicals out of zone. Ornamental Outlook 13(2):14,16.
- Chakraverty, R.K. 1970. Propagation of bougainvillea by stem cuttings. Current Sci. 39(20):472.
- Czekalski, M.L. 1989. The influence of auxins on the rooting of cuttings of *Bougainvillea glabra* 'Choisy'. Acta Hort. (251):345-352.
- Dole, J.M. and H.F. Wilkins. 1999. Floriculture: Principles and species. Prentice Hall, Upper Saddle River, New Jersey.
- Hartmann, H.T., D.E. Kester, F.T. Davies, Jr., and R. Geneve. 2002. Hartmann and Kester's plant propagation: Principles and practices. Prentice Hall, Upper Saddle River, New Jersey.
- Mcavoy, R. 1995. Basic principles of vegetative plant propagation. Conn. Greenhouse News. 1-6.
- Schoellhorn, R. and E. Alvarez. 2002. Warm climate production guidelines for *Bougainvillea* Vol. ENH874, EDIS, Univ. of Fla., Gainesville, Florida.
- Singh, B., P.K. Majumdar, and J. Prasad. 1976. Response of *Bougainvillea* cuttings under bottom heat [propagation]. Delhi Garden Mag. 13.
- Wright, R.D. 1986. The pour-through nutrient extraction method procedure. HortScience 21:227-229.

## Evaluation of Quinoclamine and Diuron for Postemergence Control of Liverwort<sup>®</sup>

Adam F. Newby<sup>1</sup>, Charles H. Gilliam, and Glenn R. Wehtje

Auburn University, Department of Horticulture, Auburn, Alabama 36849

James E. Altland

Oregon State University, North Willamette Research & Extension Center, Aurora, Oregon 97002

### INTRODUCTION

*Marchantia polymorpha*, also known as liverwort, has established itself as a primary weed in nursery production within the Southern United States. It is well adapted to nursery environments and especially propagation environments. Liverwort thrive in low UV light, high fertility, high moisture, and high humidity environments (Svenson, 2002). Therefore liverwort is especially problematic in shaded areas with frequent irrigation.

Liverwort is a physiologically primitive plant with no vascular system. Instead of leaves, it has leaf-like structures known as thalli that grow in prostrate form along the medium surface. Liverwort propagates both sexually and asexually. During the sporophytic life cycle, it propagates sexually when archegonia fertilize antheridia to form a sporophyte. The archegonia and antheridia are each borne on stalks that rise above the thalli. Microscopic spores are released and give rise to the gametophytic life cycle in which the plant propagates asexually by way of gemmae. Gemmae are basically small clones of the parent plant produced in gemma cups on the thalli. They are dispersed to the immediate area when splashed by water. Liverwort can also propagate asexually by fragmentation.

While liverwort was initially located in the Northwest and Northeast, it has spread to nursery production areas throughout the U.S.A. Some preemergence herbicides have been proven effective (Svenson, 1998; Fausey, 2003), however these cannot be used in closed structures thus creating a need for postemergence herbicides. Potential postemergence controls include quinoclamine and diuron. Quinoclamine is a chemical originally used in Japan as an algacide in rice production. It has proven to provide effective postemergence liverwort control, and a broad range of nursery crops have proven tolerant (Altland et al., 2003; Newby et al., 2004). It is produced as a 25% wettable powder. It is currently used in Europe for liverwort control. The proposed recommendation by its company is based on amount of product per gallon applied at a specified spray volume. The current recommendation is 2 oz of product per gallon applied at 2 qt per 100 ft<sup>2</sup> (219 gal per A). This recommendation is equivalent to 6.8 lbs ai/a. In a previous study, a quinoclamine rate of 1 oz per gallon applied at 1 quart per 100 ft<sup>2</sup> (109 gal/A) provided similar postemergence control compared to the recommended rate (Newby et al., 2004).

Diuron is a substituted urea herbicide registered for use in cotton. It was first registered in the 1950s. Diuron inhibits photosynthetic electron transport within the chloroplast membrane. It is used for postemergence liverwort control in Germany (Dr. Heinrich Loesing, pers. commun.).

---

<sup>1</sup>Graduate Student Research Paper Winner; 1st Place.

The objective of this research was to evaluate the use of lower quinoclamine rates and spray volumes than currently recommended and to evaluate diuron for postemergence liverwort control.

## MATERIALS AND METHODS

Two experiments were conducted at Auburn University. Sprayable herbicides were applied with a CO<sub>2</sub> backpack sprayer fitted with an 8004 flat-fan nozzle at a pressure of 30 psi and calibrated to deliver the specified spray volume.

**Experiment 1.** Full gallon containers were filled with a 6 pine bark : 1 sand (v/v) mix amended with 14 lb (8.3 kg) of Polyon 18-6-12 (Pursell Technologies), 5 lb (3.0 kg) of dolomitic lime, and 1.5 lb (0.9 kg) of Micromax (The Scotts Company) per cubic yard (cubic meter). Containers were inoculated with *M. polymorpha* and grown under mist irrigation until it covered at least 60% of the container surface. Herbicide treatments were applied on 4 Nov. 2004. Twelve quinoclamine treatments were applied in a factorial arrangement consisting of four rates and three spray volumes. Rates of 0.25, 0.5, 1.0, and 2.0 oz product/gal (0.0625, 0.125, 0.25, and 0.5 oz ai/gal) were each applied at 27, 54, or 109 gal/A (0.25, 0.5, or 1.0 qt/100 ft<sup>2</sup>). Diuron was applied at 0.5 lb ai/A and 1.0 lb ai/A. Linuron, another substituted urea herbicide with similar chemistry to diuron, was also applied as at 0.5 lb ai/A and 1.0 ai/A. Both diuron and linuron were applied at 40 gal/A. Treatments were arranged with a nontreated control group in a completely randomized design with 6 single pot replications. Data included percent postemergence control at 3, 7, 14, and 28 days after treatment (DAT) on a 0 to 100 percent scale where 0 equals no control and 100 equals death of entire liverwort within the container. As a comparison of liverwort re-growth, percent liverwort coverage of the container surface was recorded 35 and 70 DAT. Treatments were also applied to 6 single-pot replications of *Humata tyermannii* (rabbit foot fern) and *Euphorbia pulcherrima* (poinsettia) and compared to a nontreated control group in order to evaluate plant tolerance. The study was conducted in a temperature-controlled greenhouse that remained at or above 65 °F. Total irrigation applied was 0.25 inches daily split into two cycles.

**Experiment 2.** Liverwort was grown in gallon containers as described in Experiment 1. Treatments were applied on 14 March 2005 when liverwort covered at least 60% of the container surface. Nine quinoclamine treatments were applied in a factorial arrangement consisting of three rates and three spray volumes. Rates of 0.5, 1.0, and 2.0 oz product/gal (0.0625, 0.125, 0.25, and 0.5 oz ai/gal) were each applied at 27, 54, or 109 gal/A (0.25, 0.5, or 1.0 qt/100 ft<sup>2</sup>). Diuron 4L was applied at 0.5 lb ai/A and 1.0 lb ai/A at 40 gal/A. A non-treated control group was maintained. Treatments consisted of 6 single pot replications arranged in a completely randomized design. The study was conducted under a shade house with 47% shade. Cyclic overhead irrigation was applied daily at 0.5 inches per day split into two cycles. Percent liverwort control was recorded 7, 14, and 21 DAT. Percent liverwort coverage within the container was recorded 35 and 63 DAT.

## RESULTS

**Experiment 1.** Among quinoclamine treatments, rate and surfactant affected postemergence liverwort control 7 DAT and 14 DAT. In general, control increased as rate increased and as spray volume increased. At 3 DAT, rates of 0.5, 1.0, and 2.0

Table 1. Experiment 1: Liverwort control with quinoalamine, diuron, and linuron (Nov. 2004).

Herbicide	Rate oz product/gal	Volume gal/A	% Control			% Coverage
			7 DAT <sup>z</sup>	14 DAT	70 DAT	
Quinoalamine	0.25	27	33 <sup>ef<sup>y</sup></sup>	28 <sup>fg</sup>	97 <sup>a</sup>	
		54	46 <sup>ed</sup>	36 <sup>ef</sup>	97 <sup>a</sup>	
		109	61 <sup>cd</sup>	53 <sup>de</sup>	87 <sup>a</sup>	
	0.5	27	58 <sup>cd</sup>	61 <sup>cd</sup>	89 <sup>a</sup>	
		54	71 <sup>bc</sup>	66 <sup>cd</sup>	73 <sup>ab</sup>	
		109	88 <sup>ab</sup>	87 <sup>abc</sup>	79 <sup>ab</sup>	
	1	27	34 <sup>ef</sup>	28 <sup>fg</sup>	88 <sup>a</sup>	
		54	93 <sup>ab</sup>	94 <sup>ab</sup>	59 <sup>bc</sup>	
		109	97 <sup>a</sup>	83 <sup>abc</sup>	54 <sup>bc</sup>	
	2	27	82 <sup>abc</sup>	78 <sup>abcd</sup>	73 <sup>ab</sup>	
		54	81 <sup>abc</sup>	97 <sup>a</sup>	40 <sup>cde</sup>	
		109	99 <sup>a</sup>	98 <sup>a</sup>	22 <sup>de</sup>	
Main effects <sup>x</sup>			***	***	***	
rate			***	***	***	
spray volume			***	***	***	
rate*volume			NS	NS	*	
lb ai/A						
Diuron	0.5	40	35 <sup>e</sup>	70 <sup>bcd</sup>	44 <sup>cd</sup>	
		40	33 <sup>ef</sup>	86 <sup>abc</sup>	16 <sup>e</sup>	
Linuron	0.5	40	25 <sup>efg</sup>	17 <sup>fgh</sup>	94 <sup>a</sup>	
		40	10 <sup>fg</sup>	4 <sup>gf</sup>	100 <sup>a</sup>	
Control			2 <sup>g</sup>	1 <sup>h</sup>	100 <sup>a</sup>	

<sup>z</sup> Days after treatment.

<sup>y</sup> Means within a column with the same letter are similar according to Duncan's multiple range test ( $\alpha = 0.05$ ).

<sup>x</sup> Main effects of rate, spray volume, and interaction thereof among quinoalamine treatments.

NS, \*, \*\*, \*\*\* represent nonsignificant or significant at the 0.05, 0.01, 0.001 level, respectively.

Table 2. Experiment 2. Liverwort control with quinoclamine and diuron (March 2005).

Herbicide	Rate oz product/gal	Volume		% Control			% Coverage		
		gal/A		7 DAT <sup>z</sup>	14 DAT	63 DAT			
Quinoclamine	0.5	27		13	ef <sup>y</sup>	6	d	93	ab
		54		14	ef	12	d	95	ab
	1	109		29	cd	20	cd	93	ab
		27		18	de	8	d	96	ab
	2	54		40	c	18	cd	92	ab
		109		68	b	63	b	83	b
	27		35	c	19	cd	98	a	
	54		83	a	82	a	66	c	
	109		89	a	83	a	67	c	
	Main effects <sup>x</sup>		rate		***		***		***
		spray volume		***		***		***	
		rate <sup>a</sup> *volume		***		***		**	
		lb ai/A							
Diuron	0.5			3	f	35	c	23	d
	1			5	f	60	b	1	e
Control				6	ef	2	e	100	a

<sup>z</sup> Days after treatment.

<sup>y</sup> Means within a column with the same letter are similar according to Duncan's multiple range test ( $\alpha = 0.05$ ).

<sup>x</sup> Main effects of rate, spray volume, and interaction thereof among quinoclamine treatments.

NS, \*, \*\*, \*\*\* represent nonsignificant or significant at the 0.05, 0.01, 0.001 level, respectively.

oz/gal applied at 109 gal/A provided 88%, 97%, and 99% postemergence control, respectively (Table 1). Similarly, rates of 1.0 and 2.0 oz/gal applied at just 54 gal/A provided 93% and 81% postemergence control, respectively. By 14 DAT, rates of 0.5, 1.0, and 2.0 oz/gal applied at 109 gal/A provided 83% to 98% postemergence control. Again, rates of 1.0 and 2.0 oz/gal applied at just 54 gal/A provided similarly effective postemergence control. Percent liverwort coverage 70 DAT was lowest in containers treated with 2.0 oz/gal applied at 54 and 109 gal/A.

Diuron and linuron treatment means were compared to quinoclamine treatments and the nontreated control group using Duncan's multiple range test ( $\alpha = 0.05$ ). At 7 DAT, diuron provided minimal postemergence control. Linuron treatments had no postemergence effect as compared to the control group. However, diuron applied 0.5 and 1.0 lb ai/A provided effective postemergence control 14 DAT. Diuron applied at 1.0 lb ai/A provided similar control to the most effective quinoclamine treatments. Percent coverage 70 DAT in containers treated with 1.0 lb ai/A diuron was numerically lowest at only 16%.

*Humata tyermannii* and *E. pulcherrima* displayed no injury throughout the course of the study.

**Experiment 2.** As in Experiment 1, quinoclamine rate, spray volume, and the interaction thereof affected postemergence liverwort control. The rate of 2 oz/gal applied at 54 and 109 gal/A provided superior control at 83% and 89% postemergence control 7 DAT (Table 2). Rates of 0.5 and 1.0 oz/gal did not provide adequate postemergence control regardless of spray volume. Results were similar 14 DAT. Liverwort covered 66% and 67% of the surface 63 DAT in containers treated with 2 oz/gal applied at 54 and 109 gal/A, respectively.

Diuron treatments did not provide significant postemergence control 7 DAT. By 14 DAT, diuron at 1.0 lb ai/A provided 60% postemergence control, while diuron at 0.5 lb ai/A provided 35% postemergence control. By 63 DAT, percent liverwort coverage in containers treated with diuron at 0.5 lb ai/A and 1.0 lb ai/A were significantly lower than containers treated with the highest rate and spray volume of quinoclamine. Percent coverage in containers treated with diuron at 1.0 lb ai/A was only 1%, while percent coverage in containers treated with diuron at 0.5 lb ai/A was 23%.

## DISCUSSION

Quinoclamine rate and spray volume influence postemergence liverwort control. These data show that lower than recommended spray volumes and rates can provide effective postemergence control. Heavy liverwort infestations may require a higher rate/spray volume, while lighter liverwort infestations may be controlled by a lower rate/spray volume.

Percent postemergence control attained by quinoclamine treatments was higher in Experiment 1 when compared to similar treatments in Experiment 2. Experiment 1 was conducted in a temperature-controlled greenhouse. Experiment 2 was conducted outdoors, and treatments were applied in March. Quinoclamine activity is fast on liverwort. Temperatures directly after application in March dropped to 43 °F and remained below 65 °F for the following 7 days. The lower amount of postemergence control in Experiment 2 could be accounted for by the cooler outdoor temperatures. Physiological activity of the liverwort would have been lower in cooler temperatures.

Diuron provides excellent postemergence liverwort control when applied at 1.0 lb ai/A. This product is not registered for use in nursery crops, however it caused no injury to crops treated in this study. Diuron has potential as a postemergence herbicide for use in container crops.

#### LITERATURE CITED

- Altland, J., A. Newby, and R. Regan. 2003. Determine efficacy and phytotoxicity of quinclamine. *Comb. Proc. Intl. Plant Prop. Soc.* 53: 383–386.
- Fausey, J.C. 2003. Controlling liverwort and moss now and in the future. *HortTechnology*. 13:35–38.
- Newby, A., J. Altland, D. Fare, C. Gilliam, and G. Wehtje. 2004. Postemergence control of liverwort in container production. *Proc. South. Nurs. Res. Conf.* 49:396–400.
- Svenson, S.E. 1998. Suppression of liverwort growth in containers using irrigation, mulches, fertilizers, and herbicides. *Proc. South. Nurs. Res. Conf.* 43: 396–398.
- Svenson, S.E. 2002. Give *Marchantia* its marching orders. *Digger*. 46(3):39–46.

---

## Pinebark Mini-Nuggets Provide Effective Weed Control in Nursery Crops Grown in Large Containers<sup>®</sup>

Ben M. Richardson<sup>1</sup>, Charles H. Gilliam, and Glenn R. Wehtje

Auburn University, Department of Horticulture, Auburn, Alabama 36849

Glenn B. Fain

USDA-ARS, Southern Horticultural Laboratory, Poplarville, Mississippi 39470

While the market for large plants increases steadily, weed control in large containers presents new production problems for growers. Preemergence herbicides are inefficient in large containers due to nontarget loss, and hand weeding is expensive. Mulches can provide an alternative. Experiments were conducted to evaluate fresh pine bark nuggets for weed control in 7-gal containers. *Gardenia* were seeded with oxalis and crapemyrtle with bittercress. Treatments consisted of mulch applied at 0, 3.8, and 7.7 cm (0, 1.5, and 3.0 inches) and seeding was done before or after mulch. A separate group of treatments were included similar to the above except that a granular preemergence herbicide was applied after mulch application. Growth of gardenia and crapemyrtle were similar regardless of mulch depth. Season long weed control was obtained in all treatments when mulch was applied at 7.6 cm (3 inch) depth.

#### INTRODUCTION

Container nursery crops are increasingly valuable compared to agronomic crops in the southeast. However, weeds growing in containers can reduce the value of the crop by reducing growth through competitive effects (Berchielli-Robertson et al., 1990) and reducing salability due to customer demand for weed-free crops. Most growers use preemergence herbicides along with supplemental hand weeding to control weeds, thus maximizing crop value.

---

<sup>1</sup>Graduate Student Research Paper Winner; 2nd Place.



Diuron provides excellent postemergence liverwort control when applied at 1.0 lb ai/A. This product is not registered for use in nursery crops, however it caused no injury to crops treated in this study. Diuron has potential as a postemergence herbicide for use in container crops.

#### LITERATURE CITED

- Altland, J., A. Newby, and R. Regan. 2003. Determine efficacy and phytotoxicity of quinclamine. *Comb. Proc. Intl. Plant Prop. Soc.* 53: 383–386.
- Fausey, J.C. 2003. Controlling liverwort and moss now and in the future. *HortTechnology*. 13:35–38.
- Newby, A., J. Altland, D. Fare, C. Gilliam, and G. Wehtje. 2004. Postemergence control of liverwort in container production. *Proc. South. Nurs. Res. Conf.* 49:396–400.
- Svenson, S.E. 1998. Suppression of liverwort growth in containers using irrigation, mulches, fertilizers, and herbicides. *Proc. South. Nurs. Res. Conf.* 43: 396–398.
- Svenson, S.E. 2002. Give *Marchantia* its marching orders. *Digger*. 46(3):39–46.

---

## Pinebark Mini-Nuggets Provide Effective Weed Control in Nursery Crops Grown in Large Containers<sup>®</sup>

Ben M. Richardson<sup>1</sup>, Charles H. Gilliam, and Glenn R. Wehtje

Auburn University, Department of Horticulture, Auburn, Alabama 36849

Glenn B. Fain

USDA-ARS, Southern Horticultural Laboratory, Poplarville, Mississippi 39470

While the market for large plants increases steadily, weed control in large containers presents new production problems for growers. Preemergence herbicides are inefficient in large containers due to nontarget loss, and hand weeding is expensive. Mulches can provide an alternative. Experiments were conducted to evaluate fresh pine bark nuggets for weed control in 7-gal containers. *Gardenia* were seeded with oxalis and crapemyrtle with bittercress. Treatments consisted of mulch applied at 0, 3.8, and 7.7 cm (0, 1.5, and 3.0 inches) and seeding was done before or after mulch. A separate group of treatments were included similar to the above except that a granular preemergence herbicide was applied after mulch application. Growth of gardenia and crapemyrtle were similar regardless of mulch depth. Season long weed control was obtained in all treatments when mulch was applied at 7.6 cm (3 inch) depth.

#### INTRODUCTION

Container nursery crops are increasingly valuable compared to agronomic crops in the southeast. However, weeds growing in containers can reduce the value of the crop by reducing growth through competitive effects (Berchielli-Robertson et al., 1990) and reducing salability due to customer demand for weed-free crops. Most growers use preemergence herbicides along with supplemental hand weeding to control weeds, thus maximizing crop value.

---

<sup>1</sup>Graduate Student Research Paper Winner; 2nd Place.

Increasing demand for large plant material in the landscape has led to many growers producing more nursery crops in larger containers; however, weed control practices differ from that used in small containers. Increased spacing between large containers renders preemergence herbicides inefficient and environmentally unsafe due to excessive nontarget loss. Hand weeding is an option but increasingly expensive due to increasing labor costs (Gilliam et al., 1990; Judge et al., 2003).

Mulches are an alternative for weed control in large containers. Shredded tires, recycled newspaper, pole shavings, and kenaf mulch have been used as a weed control in large containers (File et al., 1999). Shredded tires and recycled newspaper provided good control but availability and acceptability by customers are limiting factors for use as mulches.

Pine bark mini-nuggets may provide a nonchemical mulch option for growers. Shredded pine bark mulch has provided good weed control in the landscape and is generally accepted by consumers (Llewellyn et al., 2003). Pine bark is readily available and could be mechanized at potting. Also, hydrophobic properties of fresh pine bark mini nuggets are not conducive for weed establishment. The objective of this study was to evaluate fresh pine bark mini nuggets for a long-term weed control in large container nursery crops.

## MATERIALS AND METHODS

These studies were conducted at the Patterson Greenhouse Complex of Auburn University, Alabama in Fall 2004 and Spring 2005. Crapemyrtle (*Lagerstroemia* 'Acoma') were transplanted from trade gallon containers into 7-gal containers on 27 Sept. 2004 and treated on 8 Oct. 2004. The substrate was 6 aged pine bark : 1 sand (v/v) amended with 2.3 kg (5 lb) of dolimitic lime, 6.4kg (14 lb) of Polyon 18-6-12, and 0.68 kg (1.5 lb) of Micromax. All plants were potted to equal depths, approximately 7.6 cm (3 inches) below the top of the container. All plants were irrigated twice prior to treatment. Three treatments consisted of broadcasting 25 bittercress (*Cardamine*) seed on each container substrate surface followed by application of pine bark mini-nugget mulch, which was hand applied at 0, 3.8, and 7.6 cm (0, 1.5, and 3 inches) deep respectively. Particle size distribution of the pine bark mini-nuggets was as follows: 11% between 2.5–5.1 cm (1–2 inches), 68% between 1.3–2.5 cm (0.5–1 inches), 14% between 0.5–1.3 cm ( $1/4$ – $1/2$  inches), and 7% less than 1.3 cm ( $1/4$  inch). Pine bark mini-nuggets were purchased for \$16 per cubic yard. Mulch cost per container was 7¢ and 15¢ for 3.8 and 7.6 cm (1.5 and 3.0 inch), respectively. Two other treatments consisted of first applying mulch at 3.8 and 7.6 cm (1.5 and 3.0 inch), then broadcasting the bittercress seeds on top of the mulch. These same treatments were repeated except that a granular preemergence herbicide (Broadstar 0.25G at 150 lb product/A) was applied after all mulch and seed were present. This study was initiated 8 Oct. 2004 with a total of 10 treatments and 10 single pot reps per treatment. All plants were placed in full sun with overhead irrigation and in a completely random design.

In a similar study, gardenia (*Gardenia jasminoides*) were transplanted from trade gallon containers into 7-gal containers on 27 Sept. 2004. On 30 Sept. 2004 the same treatments were applied to the gardenia except 25 oxalis (*Oxalis stricta*) seed were used per container instead of bittercress. In both studies, data collected were weed number per container at 30, 60, 90, and 180 days after treatment (DAT) and percent

coverage of designated weeds at 60, 90, 180 DAT. Shoot fresh weight of weeds and growth indices of crop were taken for each container at 180 DAT. Plants were covered for overwintering from 23 Dec. 2004 until 1 March 2004. Crop growth indices and general weed coverage were taken on all crapemyrtle and gardenia at 300 DAT. Duncan's multiple range test ( $\alpha = 0.5$ ) was used to separate treatment means.

## RESULTS AND DISCUSSION

**Crapemyrtle-Bittercress.** These studies show that fresh pine bark mini-nuggets can provide effective season-long weed control for nursery crops grown in large containers. At 90 DAT and 180 DAT, bittercress was growing vigorously in the no mulch, no herbicide containers. These containers averaged 48% and 100% coverage of container surface, respectively, and 59.6 g of bittercress dry weight per container at 180 DAT (Table 1). In comparison, no herbicide, 3.8 cm (1.5 inches) of mulch treatment with seeding after mulching averaged 5% coverage at 90 DAT and increased to 44% coverage of container surface and 33.7 g per container at 180 DAT. All other treatments provided excellent bittercress control at 90 and 180 DAT.

After weeding at 180 DAT (6 April 2005), crapemyrtles were placed in a nursery area for the rest of the growing season. Plants reached marketable status by 300 DAT, thus weed pressure was low throughout the summer due to the crapemyrtles' canopy shading the container surface. No herbicides were applied beyond the initial treatment. General weeds at 300 DAT showed 16% coverage of the containers surface for the no mulch, no herbicide treatment and 32% coverage for the no mulch, herbicide treatment; there was slight but minimal weed coverage in the 3.8 cm (1.5 inches) of mulch treatments. There were no weeds in the 7.6 cm (3 inches) of mulch at 300 DAT.

**Gardenia-Oxalis.** At 90 and 180 DAT, oxalis coverage in the no mulch, no herbicide treatment averaged 18.5 and 35% coverage of container surface, respectively. At 180 DAT shoot dry weight was 12.9 g per container. All other treatments resulted in minimal oxalis growth at 90 and 180 DAT. The combination of mulch plus herbicide provided complete oxalis control 180 DAT. General weed coverage at 300 DAT averaged 71% coverage per container for the no mulch, no herbicide, 56% coverage for no mulch, with herbicide and 24% for 3.8 cm (1.5 inches) of mulch, seeded before mulch with no herbicide. All other treatments with 3.8 cm (1.5 inches) of mulch contained minimal weeds similar to the containers with crapemyrtle. Results are similar for gardenia compared to crapemyrtle in that 7.6 cm (3 inches) of mulch provided excellent weed control.

Crop growth for crapemyrtle and gardenia were not significantly different among treatments at 180 DAT (Table 2). However at 300 DAT gardenia were significantly smaller in the no mulch no herbicide treatment. The reduced growth was attributed to the excessive amount of weeds in those containers.

In summary, these data show that pine bark mini-nuggets provide excellent weed control in large containers when applied at a 7.6-cm (3-inch) depth. These results are likely due to the hydrophobic properties of the fresh pine bark, the depth of the mulch, and the lack of favorable growing conditions for weed germination and growth. Growers at potting could easily mechanize the process of applying this type of mulch. Fresh pine bark mini-nuggets mulch could virtually eliminate the use of herbicides and handweeding in production of nursery crops grown in large containers.

**Table 1:** The influence of mulch and herbicides on weed control in container-grown nursery crops.

Herbicide <sup>x</sup>	Seeded <sup>w</sup>	Mulch <sup>v</sup>	Crapemyrtle				Gardenia					
			bittercress		general <sup>z</sup>		oxalis		general			
			90 DAT <sup>y</sup>	% cover	180 DAT	SDW	300 DAT	% cover	90 DAT	% cover	180 DAT	% cover
No	Before	0	48a	100a <sup>u</sup>	59.6a	16b	18.5a	35a	12.9a	71a		
No	Before	3.8(1.5)	0b	2.5c	3.5c	5cb	0.5b	0.9b	0.9b	24b		
No	Before	7.6(3)	0b	0c	0c	0c	0b	0b	0b	0b		
No	After	3.8(1.5)	5b	44.2b	33.7b	5cb	0b	2.5b	1.3b	6b		
No	After	7.6(3)	0b	1.0c	1.4c	0c	0b	1b	0.8b	0b		
Yes	Before	0	2b	8c	3.8c	32a	1.5b	2.5b	1.1b	56a		
Yes	Before	3.8(1.5)	0b	0c	0c	0c	0b	0b	0b	3b		
Yes	Before	7.6(3)	0b	0c	0c	0c	0b	0b	0b	0b		
Yes	After	3.8(1.5)	0b	0c	0c	0c	0b	0b	0b	8b		
Yes	After	7.6(3)	0b	0c	0c	0c	0b	0b	0b	0b		

<sup>z</sup>These data represent native weed populations occurring through the summer months.

<sup>y</sup> DAT= days after treatment.

<sup>x</sup> Application of a preemergence herbicide (Broadstar 0.25G 150 lb product/A).

<sup>w</sup>Timing of seeding compared to mulching, before = seeds under mulch, after = seeds on top of mulch.

<sup>v</sup>Mulch depth in cm (inch), % cover =percentage of the container surface covered by designated weed species, SDW = shoot dry weight (g/container).

<sup>u</sup>Means within column followed by the same letter are not significantly different (Duncan's Multiple Range Test:  $\alpha = 0.05$ ).

**Table 2.** The influence of mulch and herbicide on growth of gardenia (*Gardenia jasminoides*) and crapemyrtle (*Lagerstroemia 'Acoma'*).

Herbicide <sup>y</sup>	Seeded <sup>x</sup>	Mulch <sup>w</sup>	Growth-index <sup>z</sup>			
			180 DAT		300 DAT	
			Gardenia	Crapemyrtle	Gardenia	Crapemyrtle
No	Before	0	59ab <sup>v</sup>	85a	75c	129a
No	Before	3.8(1.5)	54b	77a	79bc	128a
No	Before	7.6(3)	59ab	80a	83.7ab	126a
No	After	3.8(1.5)	56ab	82a	82ab	126a
No	After	7.6(3)	56ab	80a	80b	119a
Yes	Before	0	55ab	80a	80b	131a
Yes	Before	3.8(1.5)	60a	88a	84ab	129a
Yes	Before	7.6(3)	56ab	79a	82ab	121a
Yes	After	3.8(1.5)	54b	75a	86a	123a
Yes	After	7.6(3)	58ab	74a	83ab	125a

<sup>z</sup> Growth index = height + 2 perpendicular widths/3, taken at 180 DAT(days after treatment) and 300 DAT.

<sup>y</sup> Application of a preemergence herbicide(Broadstar 0.25G 150 lb product/A).

<sup>x</sup> Timing of seeding compared to mulching, before = seeds under mulch, after = seeds on top of mulch.

<sup>w</sup> Mulch depth in cm (inch).

<sup>v</sup> Means within column followed by the same letter are not significantly different.

(Duncan's Multiple Range Test:  $\alpha = 0.05$ ).

## LITERATURE CITED

- Berchielli-Robertson, D.L., C.H. Gilliam, and D.C. Fare.** 1990. Competitive effects of weeds on the growth of container-grown plants. *HortScience* 25:77–79.
- File, S., P. Knight, D. Reynolds, C.H. Gilliam, J. Edwards, and R. Harkess.** 1999. Alternative weed control options for large container production. *Southern Nurserymans Assoc.* 44:501–504.
- Gilliam, C.H., W.J. Foster, J.L. Adrain, and R.L. Shumack.** 1990. A survey of weed control costs and strategies in container production nurseries. *J. Environ. Hort.* 8:133–135.
- Judge, C.A., J.C. Neal, and J.B. Weber.** 2003. Dose and concentration responses of common nursery weeds to Gallery, Surflan and Treflan. *J. Environ. Hort.* 21:43–45.
- Llewellyn, J., K. Osborne, C. Steer-George, and J. West.** 2003. Commercially available organic mulches as a weed barrier for container production. *Comb. Proc. Intl. Plant Prop. Soc.* 53:590–593.

---

## A Propagator's Notebook<sup>®</sup>

**Charlotte LeBlanc**

Imperial Nurseries, 1525 S Atlanta Street, Quincy, Florida 32351

### INTRODUCTION

A number of months ago a former employer, James Gilbert of Gilbert's Nursery, suggested that I might consider giving a talk for this year's I.P.P.S. program. I decided he was right. Year after year I have come with notebook in hand to eagerly seek the knowledge and wisdom so generously offered by others. It's time I shared. I have been a member of I.P.P.S. for 20 years now and have tried my hand at propagating since 1981 when I first went to work as an intern for Ed Kinsey at Kinsey Gardens in Knoxville. Not long ago, in the process of moving, I came across my original propagation notebook. While rereading those notes I realized how many of my early observations were still valid today. While I certainly value my formal education in horticulture, it became very apparent to me early on as I tried to put my knowledge to work that it was going to take a lot more than "book learning" to be a successful propagator. Propagation is a field that depends heavily on empirical knowledge. Knowledge is gained daily through experience and doing. I grew up in Appalachia where empirical knowledge was considered to have great value. "Book learning" was fine, but "real" learning came by doing. I highly value both education and experience and use both in my work. However, I think that in this modern day of high technology, we sometimes neglect our ability to learn from our observations and keen senses. We neglect to observe, follow our intuitions, or "think outside the box." The I.P.P.S. was originally founded by a group of propagators who came together to share empirical knowledge. In that same tradition, I would like to share some of my observations and thoughts during my fascinating journey in the world of propagation.

I like to compare rooting a plant to getting a chemical reaction to take place. The reaction will not take place if any of the necessary parts of the equation are left out. The same is true when rooting plants. The secret is coming up with the right combination of events. Since I have spent many years working with difficult-to-root deciduous plants such as *Acer palmatum*, *Stewartia*, and *Styrax*, I would like to share some of what I have learned. The problem with most of these plants is not only do they have a short window when the wood is in a receptive state for root-

## LITERATURE CITED

- Berchielli-Robertson, D.L., C.H. Gilliam, and D.C. Fare.** 1990. Competitive effects of weeds on the growth of container-grown plants. *HortScience* 25:77–79.
- File, S., P. Knight, D. Reynolds, C.H. Gilliam, J. Edwards, and R. Harkess.** 1999. Alternative weed control options for large container production. *Southern Nurserymans Assoc.* 44:501–504.
- Gilliam, C.H., W.J. Foster, J.L. Adrain, and R.L. Shumack.** 1990. A survey of weed control costs and strategies in container production nurseries. *J. Environ. Hort.* 8:133–135.
- Judge, C.A., J.C. Neal, and J.B. Weber.** 2003. Dose and concentration responses of common nursery weeds to Gallery, Surflan and Treflan. *J. Environ. Hort.* 21:43–45.
- Llewellyn, J., K. Osborne, C. Steer-George, and J. West.** 2003. Commercially available organic mulches as a weed barrier for container production. *Comb. Proc. Intl. Plant Prop. Soc.* 53:590–593.

---

## A Propagator's Notebook<sup>®</sup>

### Charlotte LeBlanc

Imperial Nurseries, 1525 S Atlanta Street, Quincy, Florida 32351

### INTRODUCTION

A number of months ago a former employer, James Gilbert of Gilbert's Nursery, suggested that I might consider giving a talk for this year's I.P.P.S. program. I decided he was right. Year after year I have come with notebook in hand to eagerly seek the knowledge and wisdom so generously offered by others. It's time I shared. I have been a member of I.P.P.S. for 20 years now and have tried my hand at propagating since 1981 when I first went to work as an intern for Ed Kinsey at Kinsey Gardens in Knoxville. Not long ago, in the process of moving, I came across my original propagation notebook. While rereading those notes I realized how many of my early observations were still valid today. While I certainly value my formal education in horticulture, it became very apparent to me early on as I tried to put my knowledge to work that it was going to take a lot more than "book learning" to be a successful propagator. Propagation is a field that depends heavily on empirical knowledge. Knowledge is gained daily through experience and doing. I grew up in Appalachia where empirical knowledge was considered to have great value. "Book learning" was fine, but "real" learning came by doing. I highly value both education and experience and use both in my work. However, I think that in this modern day of high technology, we sometimes neglect our ability to learn from our observations and keen senses. We neglect to observe, follow our intuitions, or "think outside the box." The I.P.P.S. was originally founded by a group of propagators who came together to share empirical knowledge. In that same tradition, I would like to share some of my observations and thoughts during my fascinating journey in the world of propagation.

I like to compare rooting a plant to getting a chemical reaction to take place. The reaction will not take place if any of the necessary parts of the equation are left out. The same is true when rooting plants. The secret is coming up with the right combination of events. Since I have spent many years working with difficult-to-root deciduous plants such as *Acer palmatum*, *Stewartia*, and *Styrax*, I would like to share some of what I have learned. The problem with most of these plants is not only do they have a short window when the wood is in a receptive state for root-



ing, but successful rooting does not guarantee that they will leaf out and grow the following spring. For many years, a common practice was to bring the plants into a heated greenhouse, take the cuttings early to ensure that they rooted, and allow the rooted liners a longer time to grow. The other concept was to place the liners under lights to extend the growing season. It finally occurred to me that maybe we were approaching the problem from the wrong direction. I'm dyslexic, so I tend to think upside down. I decided that since the root is the storage organ, it was far more important to develop a large root system. With a larger root system, the plant has enough stored carbohydrates for the shoot system to break-bud in the spring. I take large cuttings that are 13–15 cm (5–6 inches) long and leave a lot of foliage, which allows for better growth after rooting. The best time for cuttings is usually just after the first spring flush has finished and when the wood is just beginning to firm up. I use tree tubes for containers. The tree tube allows me to use a lot of mist to maintain the foliage without over-wetting the medium. I use a well-drained medium of 3 well-composted pine bark : 1 perlite (v/v). Liners seem to be very sensitive to cold the first winter. Once they have gone completely dormant, I maintain them just above freezing for the first winter. Contrary to common dogma, I fertilize unrooted cuttings using Osmocote 18-6-12 incorporated into the medium or with a short-acting fertilizer such as Sta-Green 12-6-6 (Spectrum Brands) just after removing rooted cuttings from the mist. I also liquid feed again just as the buds start to break in the spring. I have had very satisfactory results using these methods. Of course you need to adapt to your particular environment and cultural conditions. Much of what I have learned has come from closely observing recalcitrant plants.

### **STOCK PLANTS: TAKE ONLY THE BEST CUTTINGS**

In 1982, I wrote this statement in my first propagation notebook. A pretty good observation for a neophyte. Too often growers want the propagator to take wood from plants that have performed poorly and will not be sold. What is frequently misunderstood is that the cutting and liner produced are only as good as the stock plant. I respond to their resistance in allowing me to take good wood by asking a question: "Would you pick out the worst horse in the stable to breed?" I believe that although we are supposedly propagating clones, there is also genetic variability within cuttings. After all, many of the cultivars used commercially come from shoots that were discovered as off-types and later propagated. We also frequently speak of selections or types. I believe it is possible to improve clonal selections by carefully choosing the wood. At Imperial Nurseries, where I presently manage the Propagation Department, my team leader and I scout the nursery looking for the best possible block of plants for our cuttings.

### **CUTTINGS: REMEMBER YOU ARE DEALING WITH A LIVING, BREATHING ORGANISM — NOT A STICK OF WOOD**

Careful maintenance of cuttings during the collection process is vital. The cuttings may initially appear okay, even when held for long periods in the field. However, the damage often shows up later after the cuttings are stuck. We wonder what went wrong and frequently attribute the problem to erroneous causes. A mistake I have frequently seen made is packing cuttings too closely together. Living cuttings give off heat through metabolic processes, just as people do. When you fill a room full of people, it frequently gets overheated. That is exactly what happens to cuttings

when they are too tightly packed together. They overheat, suffer loss of vigor, and can die. Allowing cuttings to dry out either in the field or during processing is a frequent cause for loss in the propagation house. Obviously, some plants are more vulnerable to drying out than others. Plants with thin leaves that desiccate readily such as *A. palmatum* are much more susceptible to drying out during the collection process. I have made an astonishing discovery. No matter what part of the country I've been in, it rains somewhere between the last couple of weeks in May and the first couple of weeks in June. That particular time frame happens to coincide with the best time to take cuttings of many difficult-to-root deciduous plants. I have also had my best results with *A. palmatum*, *Stewartia*, *Styrax*, and *Betula nigra* when I take cuttings in the rain. However, my cutting crew does not necessarily appreciate the practice! The discovery of this rooting improvement under such extreme conditions has made me more fully aware of how important it is to protect cuttings during collection and harvesting. At Imperial Nurseries, we collect cuttings in the field, first thing in the morning. We put them in open baskets placed on top of each other. Burlap that is soaked with the disinfectant and algacide, Green-Shield (Whitmire Micro-Gen Research Lab) is placed on top of the baskets so the cuttings will remain cool and moist. We finish harvesting cuttings before noon. When the baskets are brought in from the field, the plants are misted before going into the cooler. As we bring the baskets out to process the cuttings, they are placed under mist until each cutter is ready to work on a basket. We also use a moist piece of burlap with each cutter's work area. We have one person apply rooting hormones. That person collects the cuttings from each workstation and, after dipping them into the hormone, arranges them in rows so the person who is sticking them for the day can easily pick them up. As the dipper works, the sticker periodically sprays the cutting again with water from a mist bottle. We put a lot of effort into protecting our cuttings from drying out while we work.

### **MIST — JUST USE THE RIGHT AMOUNT**

We frequently cannot see when a cutting is under stress. By the time cuttings of woody plants wilt, it is too late! I sometimes try to imagine myself as the plant or as the Japanese might put it: "To root the plant, one must become the plant." How would it feel if I had just been snipped off the branch that was sustaining my life? With that concept in mind, I tend to use a lot of mist until the cutting has a chance to regain its equilibrium. Close observation will show when the cutting has regained turgidity. I frequently describe it to others as: "When the cuttings can stand up." Often propagators believe cutting loss is due to excess water, when in reality it was the lack of mist and water control when the cutting was first stuck, or drying out during the collection process. Cuttings die from the bottom-up as well as from the top-down. Rotting of the bottom of the stem is just as likely to be due to too little water as to too much.

One thing that is not well recognized is the beneficial cooling effect of mist. While we are all aware that mist minimizes moisture loss due to transpiration and evaporation, we tend to be unaware of the benefits of evaporative cooling. As a student nurse, I still remember standing in the operating room cracking sterile ice to put into the thoracic cavity while we performed some of the first cardiac surgeries. While they use more sophisticated methods now, the practice was based on sound theory. As you cool tissue, you reduce metabolism. The same is also true for plants.

Cooling helps lower a cutting's metabolism, making it easier to maintain in good condition until they root. Here in North Florida, where the summer temperatures are extremely high, that concept has been very valuable. Instead of removing plants from the mist house shortly after they start rooting out, as I was originally taught, I allow them to remain in the propagation house to enjoy the benefits of cooling until they are fully rooted and start to flush out. Plant growth tends to be shut down above 27 °C (80 °F).

When the ambient temperatures are consistently higher, I have found that cuttings actually benefit from the cooling effects of mist and continue to grow. If I place them outside during high temperatures they shut down and take much longer to form a good root system.

### **HORMONES: I HAVE NEVER PUT A LOT OF STOCK IN FINDING A MAGIC HORMONE TO PRODUCE ROOTS**

I have used all kinds of rooting hormones over the years: Hormodin (#1, 2, 3), Dip 'N Grow, and K-IBA. I am presently using Chlormone K+, which I purchase from Ozzie Coor (Coor Farm Supply, Smithfield, North Carolina). I dilute it with sterile water to whatever strength I need: 1%, 0.5%, or 0.25%. I then dilute it 50% (1 : 1) with Celluwet (water thickening additive from Griffin Laboratories). I have a chart we use for mixing the hormone, and we color-code the different strengths with food coloring so that we do not confuse the solutions in our haste. I have been very pleased with the results. Like any other rooting hormone, it takes some experimentation to find what works best for each species. I have never heard or seen any experiments that discuss the interaction between temperature and hormones. However, it makes sense to me that an increase in temperature will increase the reaction of hormones. I have observed this to be true. I usually reduce hormone concentration when we reach higher temperatures. I also reduce hormones when using bottom heat, particularly with plants I have found to be hormone-sensitive, such as *Ilex*. If you decide to push cuttings too hard with too high a hormone level, cuttings can rapidly abscise their leaves. In short, too much hormone is just as detrimental as too little.

### **TIMING IS EVERYTHING — WELL, ALMOST EVERYTHING!**

From working with difficult-to-root plants, I have come to believe that every plant has an ideal time when it has a physiological state that is most opportune for rooting. We talk about finding “windows.” Most species have a window or seasonal time frame when they will optimally root. Some plants have long windows, while particularly hard-to-root plants have short windows. The windows are highly complex. They involve temperature, daylength, dormancy, condition of the wood, and probably a lot of other things we do not fully understand. When I first went to work for the late John B. Kinsey, he looked at me and said “Charlotte, ivy roots in August.” I was a little surprised by that comment, since I was still in school and had learned that you could root ivy just about any time. I soon found out that he was right. If you stick ivy in August it will root almost instantly. Of course it will root at other times, but much more slowly. I put a lot of emphasis on finding the very best time to stick a particular plant. Why fight nature? Instead, I try to work with it. I am frequently asked if I can stick a cutting during an unfavorable time. My answer is always, “Yes, but when it roots is another story.” It has been my experience that

when a cutting is stuck at an unfavorable time, the cutting may eventually root, but it never makes a very good liner. When working with unfamiliar plants or in a new location, I have found that when the plant actually roots is a very good indication of when it will optimally root. If I subsequently propagate it during that time, I will have far better results. At Imperial Nurseries, we work hard to develop a cycle that both works for propagation and has the rooted liners ready to pot so that they will meet the sales needs.

### **THE PROPAGATOR IS ONLY AS GOOD AS HIS OR HER EQUIPMENT**

Several times I have had the opportunity and pleasure to design my own greenhouses. I was one of the first people to insist on a self-starting generator. Many nurseries now seem to feel it is worth the cost. I also like to have as much redundancy in my watering system as possible. Last year when we needed a new pressure tank, we decided to put in two tanks for water storage, along with two pumps to fill them and two pumps to pump water to the greenhouses. If either system fails, we have a back up.

### **IMPORTANCE OF PEOPLE!**

Shortly after I went to work for Gilbert's Nursery, Susie Strong made a statement that has stuck with me because it held an important truth. She said, "I can never decide what is most important — the plants, the customers, or the employees." As plant people, we tend to be very fascinated with plants. One fellow propagator confessed that his wife got very angry with him, because he only took pictures of plants and never of people. As a manager, I try to treat my employees with the same care and concern that I apply to my plants. Selecting good employees is like carefully selecting cuttings. Find the best ones. Everyone has a different management style, but I like to think of myself as a teacher rather than a manager. With few exceptions, most people want to do well at their job and be recognized. As a manager I feel it is up to me to help them succeed and that means teaching them how to do their jobs well. It is also up to me to create a team atmosphere of cooperation. Every person on the team has an important role. I'm constantly surprised and delighted by what we can achieve when we work well as a team. I pay piece rate at the nursery. A bonus is given for production over the expected rate, which is divided among all the team members.

While we work hard, I think it important to also play together on occasion. We recently had a Labor Day Picnic at Imperial Nurseries. Our Vice-President of Farm Operations, Ed Sossaman, volunteered to sit in the dunking booth, as did several other managers. Ed was the most popular of course. It was great fun for the employees to have someone of authority join in the spirit of fun. We charged for the balls and donated the proceeds to the Katrina Hurricane effort. We also had a horseshoe competition, a flower arranging contest, and a watermelon-eating contest. Such activities build team spirit.

Every day the propagator is faced with the wonderful and still only slightly understood world of living things. It was my curiosity about the living plant world that attracted me in the first place, and it is that same curiosity that keeps me coming back day after day in the heat, cold, rain, and wind. I love the uncertainty. I love the continuing quest to understand and the reality that I will never totally unravel the mysteries that living plants present to me daily. I think we are very fortunate to have work that keeps us in tune the world around us. Virtual reality may be fine for some people, but personally I like the "Real World."

# Tropical Heat: New Coleus Introductions From the University of Florida®

**Penny Nguyen and David Clark**

Department Environmental Horticulture, University of Florida, 1545 Fifield Hall, Gainesville, Florida 32611-0670

## INTRODUCTION

*Solenostemon scutellarioides*, commonly known as coleus, is a versatile annual bedding plant that is valued for its brightly colored foliage, rapid growth rate, and superior performance in landscapes in the United States of America. Surveys conducted at University of Florida at our May 2005 field day showed that 47% of the public (home gardeners and industry) choose foliage color as the main reason for buying coleus and 21% choose coleus for highly branched growth habit. A tremendous amount of variability in this crop has allowed for the selection of coleus cultivars with many novel foliage colors, growth habits, and leaf shapes. In the 2nd year of our breeding program, over 10,000 coleus seedlings were grown and evaluated in greenhouses on a 1–5 rating scale (1 = poor; 5 = excellent) based on the following characteristics: bright and novel colors, consistency of color patterning, plant vigor, lateral branching, and time to induction of flowering. Seedlings that were eliminated early on from the program either had uninteresting foliage color, poor nonbranching growth habit, or started flowering by the time they reached 8 weeks of age. Based on total scores, approximately 250 “elite” cultivars were selected, and after vegetative propagation, cultivars that displayed poor rooting characteristics were eliminated from the trialing program (only five cultivars) and the remaining elite cultivars were then transplanted at three main trialing locations: full sun in Citra, Florida (hot sun trial), full sun in Richfield, North Carolina (cool sun trial), and under 30% shade in Gainesville, Florida (hot shade trial). Several new cultivars with excellent performance in all trials for all variables were selected, and several potential challenges were identified that we plan to work on the upcoming year. In addition, the production of cultivars with the trailing habit and brightly colored foliage by directed genetic crosses have been promising to date. Hybrid F1 seedlings with trailing habit and brighter foliage colors have been produced in the past 3 months and are now being trialed in the greenhouse.

## POTENTIAL CHALLENGES AND PRELIMINARY RESULTS

**Color Fading.** From the inception of this breeding program, we have observed that many brightly colored coleus cultivars grown in warm, sunny environments have foliage that either burns and becomes necrotic, or transitions to completely dull green or maroon in appearance (Fig. 1A-D), with only a few that remained consistently bright (Fig. 1E-F). It appears that this characteristic may be the most difficult problem for us to solve to date, but we have made significant progress. When all observations were combined, over 80% of our elite cultivars had foliage that transitioned to dull maroon or green in appearance in all trialing locations, while less than 5% of these cultivars displayed burning and necrosis. Approximately 15% of the elite cultivars had foliage color that remained bright and consistent in all locations—most of these plants remain in the breeding program, and seeds are being produced from

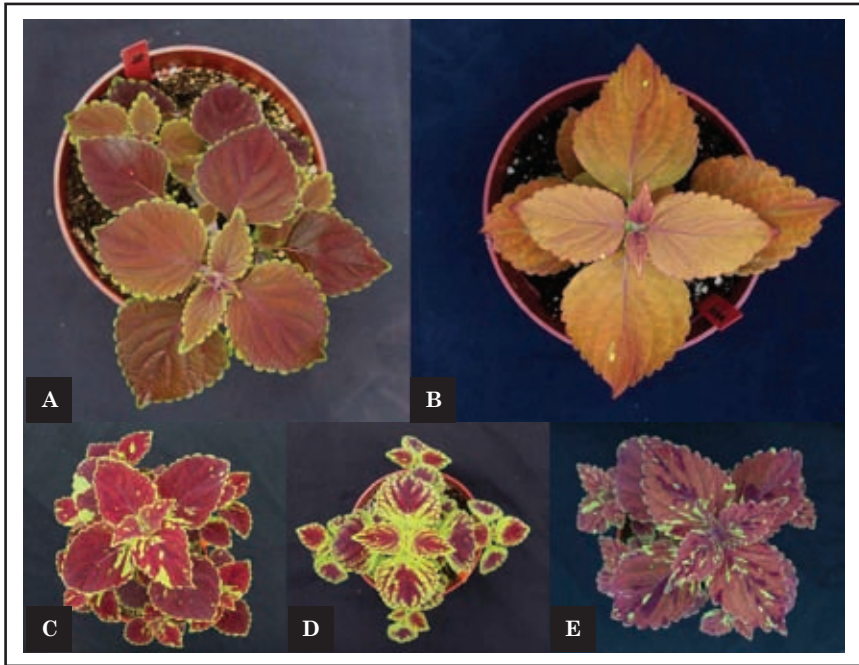




**Figure 1.** Effects of two light intensities on coleus foliage color (A, C, E) light intensity at  $4,500 \pm 500$  foot candles (fc) (B,D,F) light intensity at  $9,500 \pm 500$  FC; (A-B) cultivar 03-1-13 (C-D), cultivar 03-8-3 (E-F), cultivar 04-18-1.

them for testing in our 2006 crop in order to try and increase the number of cultivars with bright color that is stable in a wide range of environments.

**Groundcovers or Hanging Baskets.** Currently, there are several excellent standard coleus cultivars being sold in the bedding plant markets of the southern United States. However, the number of coleus cultivars available that are groundcover or trailing habit types is limited to a handful of rangy or weak cultivars with either red or green foliage. The current industry standard for trailing coleus cultivars is 'Red Queen', which flowers continuously and has good trailing habit and vigor, but has small leaves that are dull green or purple in color. In an effort to introgress bright-colored foliage with trailing habit, a cross between 'Red Queen' (trailing habit, purple foliage) and 'Sedona' (upright habit, orange/yellow foliage) has been made, resulting in the production of F1 hybrid seeds (Fig. 2). Over 300 seedlings



**Figure 2.** Top row left to right. Parental plants used in the directed genetic crosses to produce F1 hybrids. (A) Commercial trailing cultivar 'Red Queen', (B) commercial standard upright cultivar 'Sedona', (C, D, E bottom row) F1 hybrids from 'Red Queen' (♀) × 'Sedona' (♂) crosses.

of the crosses were planted 4 weeks ago and are being compared with seedlings produced from self-pollinating the two parents. Preliminary observations confirm that several of the F1 hybrid seedlings have both trailing habit and brighter foliage color than seedlings produced from self-pollinating 'Red Queen', but none of these seedlings have foliage color as bright as the seedlings produced from self-pollinating 'Sedona'. We are currently screening all of the F1 hybrids in the greenhouse and will produce F2 generation seeds by self-pollinating F1 individuals with trailing habit and brighter foliage color than 'Red Queen'. We hope to trial these selections in hanging baskets and in our sun and shade trials in 2006.

**Plant Vigor and Branched Growth Habit.** It is evident that developing a wide range of vigor in coleus is not problematic for our breeding program. Plants that were vigorous growers as seedlings continued to grow strong as mature plants, while weaker growing seedlings were less vigorous mature plants. Plants with less vigor got off to a poor start after planting in the field in April and continued to grow slowly throughout the season in all locations tested. Although many of these plants reached maturity in Florida plantings, they were usually too weak to avoid being overtaken by weeds in North Carolina. The most vigorous cultivars grew so large under Florida conditions that they would likely require landscape maintenance for pruning, but these cultivars performed well under the cooler conditions of North Carolina. Cultivars that are best suited for growth in Florida that require low amounts of landscape maintenance often had inconsistent performance in North Carolina.



It also appears that developing coleus cultivars that are highly branched is also achievable through our program. We were able to determine that seedlings showing highly branched plant architecture almost exclusively displayed this characteristic within the first 8 weeks of seedling growth, thus providing an easy method to screen for during the early stages of evaluation. These cultivars continued to be highly branched throughout the season in all trials; thus most elite cultivars had branching patterns suitable for both landscape use and for production of an economically feasible number of vegetative propagules on stock plants.

**Late Flowering Cultivars.** Coleus cultivars that initiate flowering early and often are usually not desirable for landscape use for two main reasons: (1) Initiation of flowering and seed set induces stored reserves to be mobilized from leaves to these reproductive tissues, thus reducing foliage visual quality, and (2) To avoid reductions in foliage quality due to this altered source : sink ratio, consumers or landscape professionals must spend effort to prune flowers to maintain desirable foliage. Therefore, we have given much attention to the selection of coleus cultivars that either flower late in the season or do not initiate flowers. Although we have eliminated several seedlings from the program due to early flowering characteristics, we have had little trouble isolating cultivars that flower late in the season. A small number of cultivars that have not flowered as of late August 2005 have also been selected, and many of these have proven to retain excellent foliage color characteristics throughout the season. Unfortunately, these cultivars may prove to be terminal in our breeding program, because it may prove too difficult to get seeds from these plants to incorporate into the future of our program without conducting work on identifying the flowering signals. We will continue to select against early flowering cultivars in the future to allow for gradual gains to be made over time.

## CONCLUSIONS AND RECOMMENDATIONS

It is apparent to us that the incredible amount of genetic variation available in coleus is capable of producing a number of excellent cultivars for use in the cutting propagated bedding plant industry. Advanced cultivars that have highly branched plant architecture and late-season flowering are attainable through standard selection practices for these characteristics. A more difficult characteristic to obtain in these cultivars is brightly colored foliage that stays bright and consistent over a wide range of environmental conditions. After screening over 10,000 seedlings in 2005, we were able to select for approximately 40 cultivars that had the complete combination of characteristics we were looking for. These cultivars are well branched and have brightly colored foliage in sun and shade under both hot Florida conditions and cooler conditions of North Carolina. We have received a great deal of interest in these cultivars from three major bedding plant breeding/production companies, and we are currently working to allow each company to test these cultivars independently. In 2006, we hope to have initial data back from these companies to determine whether any of these cultivars have commercial utility. Directed genetic crosses to produce coleus cultivars with bright-colored foliage and trailing habit for use in hanging baskets and as groundcovers have been quite successful to date. Tests to determine color stability of these plants are currently underway, and cultivars with the best trailing habit and brightest foliage colors are being advanced in our breeding program for the upcoming year. Cultivars resulting from

these efforts will fill a valuable niche in the landscape industry, which is continuously searching for groundcover plants that produce good color in shady environments. Our program strives to produce new and better coleus selections for the commercial arena as well as producing information for the academic field. Our goal for the coleus-breeding program is to generate new selections that will meet today's demands in ornamental excellence.

---

## The China Connection — People, Plants, and Plans of a Horticultural Giant®

**David L. Creech**

Stephen F. Austin University Mast Arboretum, PO Box 13000, Nacogdoches, Texas 75962

### INTRODUCTION

China's incredible growth and development in the past decade has been the subject of many television specials and print media articles. The facts and figures are astounding: Seventy-five percent of the world's cranes, 40% of the world's concrete, and 16,000 new joint ventures last year alone. China is about to become the big consumer of world oil and steel and graduates 160,000 new engineers each year. These graduates enter an economy boasting a growth rate in the double-digit range. In the midst of all this change, the central government has embraced the regreening of China's industrial base with unimaginable vigor. The "golden triangle" of eastern China is marked by the huge population that lies in and between Nanjing, Shanghai, and Ningbo — an area considered a major economic engine of Eastern China. This region has endured disturbance for thousands of years, but only in the last two decades has it seen a surge in population, the result of an amazing rural to urban migration, a migration driven by the promise of an industrialized China. The area is comparable in many respects to the southeastern U.S. [U.S.D.A. Hardiness Zone 7–9 with 1016–1524 mm (40–60 inches) rainfall per year, with substantial summer rains and drier winters].

The landscape of the watershed and floodplains of the Yangtze is a sight to behold. Attractive concrete apartments are commingled with government buildings, shops, factories, and fruit, vegetable, fish, and animal farms. One thing is apparent: China's land use planners have not shortchanged trees as a part of the picture.

China celebrates the idea that cities featuring refined parks, tree-lined streets, and plenty of vegetation are better than those that don't. Urban landscapers focus their energy on highways, roads, parks, river walks, plazas, canals, and waterways. In fact, China mandates that citizens of large cities be within a thousand meters of a grandiose park. This is horticulture at its biggest. Main thoroughfares in city and urban environs often sport wonderful tiers of vegetation. These tree and shrub plantings take in the gamut of ultimate plant sizes, from small shrub/tree plantings to broad, long landscapes of trees destined to be patriarchs that will provide shade and comfort for citizens in these huge cities. With three million new cars on the roads in China each year, urban planners are in a hurry to make the changes needed for their industrious and very crowded citizens. A center medium of trees and shrubs, then two to four lanes for vehicular traffic, a line of vegetation, bicycle

these efforts will fill a valuable niche in the landscape industry, which is continuously searching for groundcover plants that produce good color in shady environments. Our program strives to produce new and better coleus selections for the commercial arena as well as producing information for the academic field. Our goal for the coleus-breeding program is to generate new selections that will meet today's demands in ornamental excellence.

---

## The China Connection — People, Plants, and Plans of a Horticultural Giant®

**David L. Creech**

Stephen F. Austin University Mast Arboretum, PO Box 13000, Nacogdoches, Texas 75962

### INTRODUCTION

China's incredible growth and development in the past decade has been the subject of many television specials and print media articles. The facts and figures are astounding: Seventy-five percent of the world's cranes, 40% of the world's concrete, and 16,000 new joint ventures last year alone. China is about to become the big consumer of world oil and steel and graduates 160,000 new engineers each year. These graduates enter an economy boasting a growth rate in the double-digit range. In the midst of all this change, the central government has embraced the regreening of China's industrial base with unimaginable vigor. The "golden triangle" of eastern China is marked by the huge population that lies in and between Nanjing, Shanghai, and Ningbo — an area considered a major economic engine of Eastern China. This region has endured disturbance for thousands of years, but only in the last two decades has it seen a surge in population, the result of an amazing rural to urban migration, a migration driven by the promise of an industrialized China. The area is comparable in many respects to the southeastern U.S. [U.S.D.A. Hardiness Zone 7–9 with 1016–1524 mm (40–60 inches) rainfall per year, with substantial summer rains and drier winters].

The landscape of the watershed and floodplains of the Yangtze is a sight to behold. Attractive concrete apartments are commingled with government buildings, shops, factories, and fruit, vegetable, fish, and animal farms. One thing is apparent: China's land use planners have not shortchanged trees as a part of the picture.

China celebrates the idea that cities featuring refined parks, tree-lined streets, and plenty of vegetation are better than those that don't. Urban landscapers focus their energy on highways, roads, parks, river walks, plazas, canals, and waterways. In fact, China mandates that citizens of large cities be within a thousand meters of a grandiose park. This is horticulture at its biggest. Main thoroughfares in city and urban environs often sport wonderful tiers of vegetation. These tree and shrub plantings take in the gamut of ultimate plant sizes, from small shrub/tree plantings to broad, long landscapes of trees destined to be patriarchs that will provide shade and comfort for citizens in these huge cities. With three million new cars on the roads in China each year, urban planners are in a hurry to make the changes needed for their industrious and very crowded citizens. A center medium of trees and shrubs, then two to four lanes for vehicular traffic, a line of vegetation, bicycle

path, another line of vegetation, and wide sidewalks for pedestrians is the approach for many of the avenues in city centers.

The new super highway that runs from Shanghai to Nanjing and further west is proof positive of the commitment to urban forestry. This main toll highway links the downtowns of major cities and manufacturing areas and is 242 km (150 mi) long, with four lanes going west and four lanes going east. The center medium is a highway blur of very uniform Chinese juniper, *Juniperus chinensis*. The species was selected because it responds to pruning, is durable and dense enough to “reduce oncoming vehicular headlight distraction.” If that isn’t enough, both sides of the highway are thickly planted to a wide collection of trees, and not just an occasional specimen. Roadside forests are three and four tiers deep, almost always planted at very high density. Trees and large shrubs are generally field dug in tightly packed nurseries with a small root ball and then pruned hard. Trunks and main branches are commonly wrapped with jute rope to prevent the trunk from “drying,” and trees are kept moist during the first season of growth. The species list for street trees and shrubs in southeast China is extensive, with over 200 species grown to fit the needs of specific landscape requirements. Several may be a surprise to many U.S.A. horticulturists. For instance, the camphor tree (*Cinnamomum* sp.) is a staple almost everywhere simply because it’s accepted as a very durable evergreen, medium-sized tree that tolerates high-traffic landscapes. Sycamores of various species are popular and often pollarded. *Persea* (syn. *Machilus*), *Michelia*, and *Phoebe* make their presence known. A weeping *Sophora japonica* is quite popular. Our very own U.S.A. native, the great southern magnolia, *Magnolia grandiflora*, is common. *Liriodendron chinense*, *Liriodendron tulipifera*, and the hybrid are widely utilized. Deodar cedar, *Cedrus deodara*, is often spotted in grand colonies making blue exclamation points. The dawn redwood, *Metasequoia glyptostroboides*, bald cypress, *Taxodium distichum*, and, to some extent, the pond cypress, *Taxodium distichum* var. *imbricarium* (syn. *T. ascendens*), are common. One of the front-runners in terms of sheer numbers and growing in popularity is the bald cypress, *Taxodium distichum*, a native of southern U.S.A. While the dawn redwood and Chinese water cypress, *Glyptostrobus pensilis*, are still planted extensively, the bald cypress is everywhere and makes a huge statement in the landscape of the Yangtze delta.

## TAXODIUM

The fact that the bald cypress has found a good home in southeast China shouldn’t be surprising (Creech, 2003). After all, the bald, pond, and Montezuma cypress (*T. distichum*, *T. distichum* var. *imbricarium*, and *T. mucronatum*), respectively, have few problems in the U.S.A. A studied comparison reveals that the climate, topography, and soil of southern China fit bald cypress requirements across a wide region. Taxodiums are tough, long-lived deciduous conifers particularly well adapted to wetland habitats, yet they perform admirably in drier spots if given a little attention during the establishment years. The bottom line is that it’s a durable landscape tree in the U.S.A. and in China. There are other factors driving increased use in China. After many years, the species makes a fine, high quality lumber, and patience is considered a high virtue in China. It performs well in compacted, low-oxygen or swamp conditions. Salt-tolerant types of *Taxodium* make fine candidates for high alkalinity soils—and salty wetland reclamation projects. They can stand up in a hurricane. In the right spot, their potential longevity and size is astounding.

DNA analyses classify *T. distichum*, which ranges widely across the Southern U.S.A., as the species, with *T. distichum* var. *imbricarium* and *T. mucronatum*, native to Mexico and southern Texas, as varieties. It has come to the author's attention that changes in the nomenclature of the genus *Taxodium* have been proposed [see Aronold and Denney (in press, 2006) and Lickey and Walker (2002)] and if accepted will include the following name changes:

Replace *T. distichum* with *T. distichum* var. *distichum*

Replace *T. ascendens* with *T. distichum* var. *imbricarium*

Replace *T. mucronatum* with *T. distichum* var. *mexicana*

These changes have not been included in the text because they have not been accepted as of the date of publication. *Taxodium mucronatum* has fast growth, alkalinity tolerance, no knees, holds its foliage longer, flushes earlier in spring, is often open, wide, and unbalanced, generally not as hardy, and not usually as uniform, columnar or clean as *T. distichum*. While native to the southern U.S.A. and Mexico, there have been few efforts in the U.S.A. to improve *Taxodium* via controlled crosses and selection of superior types. In China, however, breeders have a 40-year history working with selecting improved progeny of controlled crosses — and multiplying them by cutting propagation. In China, where *T. distichum* is widely used as shelterbelt and urban trees, hybrids combine the best characteristics of each species, and fast-growing clones have been developed. The clone T302 (a *T. distichum* × *T. mucronatum* hybrid, introduced into U.S.A. as *Taxodium* 'Nanjing Beauty'), T401 (*T. distichum* var. *imbricarium* × *T. mucronatum*), and T202 (*T. distichum* var. *imbricarium* × *T. mucronatum*) are suitable for alkaline and salt-rich coastal floodplains with 8.0-8.5 pH. Controlled crosses between *T. distichum* and *T. mucronatum* have been verified as true interspecific hybrids by Karyotype analysis (Zhao et al., 1992). Attributes of T302 included faster growth than *T. distichum*, good columnar form, longer foliage retention, almost double the alkalinity tolerance of *T. distichum*, no knees, and easy rooting when juvenile. Clone T302 was introduced into the U.S.A. in January 2002 and, with the permission of the Nanjing Botanical Garden, given the name *Taxodium* 'Nanjing Beauty' in 2003. This cultivar was selected in 1988 from a batch of seedlings that were the result of a cross made by Dr. Chen Yong Hui in 1980 between *T. distichum* and *T. mucronatum*. Propagation is via cuttings taken in May and June from plants grown 1 year and then pollarded at about 1 ft height. Pollarding creates numerous upright vigorous shoots, the best kind of cuttings for early June propagation. I have seen three nurseries in China specializing in this particular clone, each propagating hundreds of thousands of T302. Rooting percentages observed were excellent. The scientists are convinced that the key to good rooting is the quality of cutting wood and mist control. While hormones are used, this is not seen as very important.

The SFA Mast Arboretum in Nacogdoches, Texas, acquired two clones, T140 and T27, in March 2005, which are considered more evergreen and salt tolerant than T302; T140 grows faster than T27, which produces a wider profile and they show strong *T. mucronatum* characteristics with improvement in form and vigor. The Chinese believe they have selected another clone, T1, that will be superior to both T140 and T27, but more genotype and environment studies are needed. The foundation of the most recent selections is derived from crosses made by Professor Chen and Liu in 1992 at the Nanjing Botanical Garden. Pollen from *T. mucronatum* was applied to T302, and fifteen selections were made in 1995. The main characteristics

for selection were: (1) fast growth rate, (2) dark green color during the growing season and a red-orange leaf color in the autumn, and (3) evergreen leaves. In 2006 or 2007, the results from T140 and T27 will be reported and registered with the Chinese Forestry Department. It will be at least 5 years before T140 and T27 enter commerce. In June, 2005 there were less than 100 each of these two clones. Clones T118, 120, and 149 have already been registered with the Chinese Forestry Department at the provincial level, while T302 has been registered at the national level.

*Taxodium* improvement work at the Nanjing Botanical Garden is currently directed by Professor Yin Yunlong. The SFA Mast Arboretum has assisted the project by providing seed from various provenances in the southern U.S.A. (*T. distichum* and *T. distichum* var. *imbricarium*), Mexico (*T. mucronatum*), and New Mexico (cold-hardy *T. mucronatum*, Las Cruces, New Mexico). The Chinese *Taxodium* improvement project has been intense for many years, and this southern U.S.A. native plant is being planted in huge numbers (millions) in southeastern China. In addition, it has recently been verified that Professor Ye Peizhong, Nanjing, created *×Taxodiomeria* in 1963, a cross of *T. mucronatum* with *Cryptomeria japonica* var. *sinensis*. The cross has been repeated and verified by DNA analysis but has yet to be imported into the U.S.A. At the Nanjing Botanical Garden, fields of seedling hybrid Liriodendrons are under selection, and several cultivars are propagated via grafting and marketed in the region. Sun and cold tolerant michelias are also a focus of the tree improvement-breeding program.

Where will all these millions of trees be planted? One possible home is a remarkable project along the coast, a coastal dike system for the Shanghai and Ningbo coastlines over 700 miles long. The dike is China's strategy to deal with the devastating blows of typhoons and storm surges, every bit as intense as the recent hurricanes that have afflicted U.S. Gulf Coast. Long stretches of the dike complex are managed via locks that reduce the inflow of salty tidal waters and are managed to change salt flats to soils more suitable for trees and human use. In August 2005, the People's Republic of China committed two billion dollars for a coastal dike "windbreak forest" project, a man-made forest several hundred meters wide and hundreds of miles long on the mainland side of the dike with substantial plantings planned in and part of constructed wetlands and "parks." The estimate of 75 billion trees needed for planting in the next two decades was provided to me by several sources, but I have been unable to verify this astounding number. The mix of salt-tolerant trees and plants planned for the project is quite extensive and the acreage planted appears healthy. The government's commitment to a windbreak forest has resulted in a heated nursery buildup in the region with nursery and landscape companies developing strategies to capture a portion of this new and unique market.

### **SWEET OSMANTHUS (*OSMANTHUS FRAGRANS*)**

I was invited by Professor Xiang Qibai of the Nanjing Forestry University to participate in the First International Symposium on Sweet Osmanthus, 4-7 Oct. 2004, in Shanghai, China, and to present the paper "Status and Use of *Osmanthus fragrans* in Southern U.S. Landscapes." The conference was attended by 108 participants from 11 countries. I was accompanied by Bill Brown, General Manager of Magnolia Nursery, Waller, Texas. China has applied to the International Horticulture Society to be the official International Registry for the genus, and while that application is pending, there's good reason to think it's justified.



The ancient sweet *Osmanthus* of China is one of the ten traditional flowers of China. It is heavily planted in landscapes, parks, and roadsides. The Chinese revere the plant for its durability, character, fragrance, and landscape utility in high-traffic landscapes. Old trees are respected, signed and interpreted, and given holy attendance. Protective fences mark their importance. Tourists flock to admire their size and glory. The most ancient plant known in China rests comfortably in the grounds of the Shengshui Temple, Nanzheng County, Shanxi Province, and is over 2100 years old. It is 12.2 m (40 ft) in height, and this magic tree was planted by the Xiaohe himself, the Minister of the Han Dynasty. One of the most impressive trees is the stately specimen in the landscape of Linggu Temple, Nanjing city, Jiangsu province. This dense-foliaged giant is over 6.4 m (21 ft) in height and sports a crown diameter of 7.3 (24 ft). It rests alone in the valley, and when it is in bloom on an early October morning, the entire valley is filled with its magic fragrance. During October when the species is at its best, over ten Chinese cities honor the plant with a wide range of special holidays. In a carnival-like atmosphere, Chinese citizens flock to sweet *Osmanthus* gardens to enjoy festivals celebrating the sweet *Osmanthus* as a national treasure of China.

There are 157 cultivars of sweet *Osmanthus* in China divided into four main groups: Siji, Albus (or Thunbergii), Luteus, and Auranticus (Zang and Xiang, 2004). Cultivars have been selected for flower size, abundance of flowers, characteristics of the flowers, time of bloom and reblooming tendency, tree form and habit, bark, branch, leaf, pedicel, and fruit. When one realizes that sweet *Osmanthus* has been in cultivation in China for over 2000 years, it's not surprising that so many cultivars and forms have proliferated. Only now, however, has China made a national mission to acquire superior clones, propagate them, improve the genus, and popularize the plant worldwide. For instance, the Hangzhou Ludi Seed Company includes the Hangzhou Sweet Osmanthus Variety Cultivation Base, a single nursery (33 ha) in the mountains just west of Hangzhou, a nursery dedicated solely to the production of sweet *Osmanthus*, with an inventory of 1.5 million plants and 40 cultivars.

There is enormous opportunity to popularize sweet *Osmanthus* in the U.S.A. with cultivar improvements. One recent introduction into the U.S.A., *O. fragrans* 'Fudingzhu', or more popularly known as 'Nanjing Beauty', is exceptionally floriferous and known to flower quickly in the container. *Osmanthus fragrans* f. *aurantiacus* is the orange form found occasionally in the landscapes of the southern U.S.A., and it is a treasure when it reaches peak bloom and fragrance. The SFA University Mast Arboretum has eight cultivars, including two that are reported as red-flowering forms (yet to bloom in the garden). I have seen *O. fragrans* 'Zhusha Dangu' and while I caught it just past peak with petals a bit spent, I can say, yes, it's red enough to make the mark.

## SHANGHAI FLOWER PORT

In Oct. 2004, I visited the Shanghai Flower Port Enterprise Development Co. Ltd. (SFPED, No. 2 Shengdong Rd. Donghai State Farm, Nanhui District, Shanghai, China P.R. 201303). This star corporation was funded in Sept. 2002 via a multitude of domestic and international sources and is recognized as one of the leading industrialization companies in Shanghai. With 40 ha of modern climate-controlled greenhouses and plans for expansion, the 250-ha complex includes a 28 ha theme park to evaluate and display new plant materials for domestic and export opportu-



nities. Shanghai Flower Port Enterprise Development Co. Ltd. is located between Shanghai's Pudong International Aviation Port and Pudong's Yangshan International Deep-Water Port. Shanghai Flower Port Enterprise Development Co. Ltd. sets up long-term partnerships with companies from around the world including Holland, Germany, Israel, Japan, and China Taiwan. The mix of enterprises involved include the Sino-Dutch Horticultural Training and Demonstration Center, Shanghai Flower Port Enterprise Development Co. Ltd., Shanghai Jetgreen Agriculture Bio-Tech Co. Ltd., Asia East Fields Co. Ltd., Shanghai Sino-Dutch Horticulture Flower Co. Ltd., Shanghai Sino-Dutch Flower Co. Ltd., and the Shanghai Sino-Dutch Horticulture Nursery Co. Ltd. Eastfields produces millions of geranium and poinsettia rooted cuttings in cooperation with the Fischer Group of Germany, and 95% of its products are exported, primarily to the U.S.A.

## CONCLUSION

Horticulturally, China is on the move and the sheer volume of nursery production is staggering. Low-tech nursery practices that are efficient and proven are clashing with new technologies and new plant materials. Joint ventures are everywhere. Researchers at universities and botanical gardens are strategizing, breeding, and selecting improved trees for the urban landscape. The fact that native southern U.S.A. germplasm is connected to that breeding effort promises interesting plants for specific sites and demanding conditions. While the U.S.A. is underrepresented in the horticulture business world of China compared to other countries, the potential for healthy exchange of new plant materials, ideas, and business opportunities appears unlimited.

## LITERATURE CITED

- Anonymous.** 2004. Ancient sweet osmanthus in China. Special publication for the 1st International Sweet Osmanthus Conference, Shanghai, China. (4–7 Oct. 2004) by the Osmanthus branch of Chinese Floral Association, Osmanthus Research Center, Nanjing Forestry University, Nanjing 210037, Jiangsu, P.R. China.
- Anonymous.** 2004. Illustration of cultivars of sweet osmanthus in China. Special publication for the First International Sweet Osmanthus Conference, Shanghai, China. (4–7 Oct. 2004) by the Osmanthus branch of Chinese Floral Association, Osmanthus Research Center, Nanjing Forestry University, Nanjing, China.
- Arnold, M.A., and G.C. Denney.** 2006. Taxonomy and nomenclature of Baldcypress, Pondcypress, and Montezuma Cypress: One, two, or three species? HortTechnology (in press).
- Creech, D.** 2003. The bald and the beautiful. 2003. Amer. Nurseryman 197(4):30-35.
- Lickey, E.B., and G.L. Walker.** 2002. Population genetic structure of baldcypress (*Taxodium distichum* (L.) Rich. var. *distichum* and Pondcypress (*T. distichum* var. *imbricarium* (nuttall) Croom: Biogeographic and Taxonomic Implications. Southeastern Naturalist 1(2): 131–148.
- Zang, D., and Q. Xiang.** 2004. Studies on *Osmanthus fragrans* cultivars. The First International Symposium on Sweet Osmanthus Special Issue. J. Nanjing Forest. Univ.28:7–13.
- Zhao, C.-M., C. Zhong, N. Qixin, C. Yonghui, and S. Zuijun.** 1992. The Karyotype analysis of *T. Zhongshannica* '401'. J. Jiangsu For. Sci. Tech. (1):8–11.

# Methods and Techniques to Improve Root Initiation of Cuttings®

**Mark Crawford**

Loch Laurel Nursery, 2867 Carroll Ulmer Rd., Valdosta, Georgia 31601

## INTRODUCTION

Plants rooted from cuttings need to have ample roots developed along the stems to provide good growth and proper anchorage. With the increase in clonal production of shade trees and large conifers, good root initiation is essential for long-term survival. Numerous nursery-produced trees were severely damaged during the hurricane season of 2004, with the majority falling over from poor root development. Adequate root initiation and development must occur during the propagation phase to assure good stability and long life of nursery-produced trees.

Stability of trees has been of concern to foresters for many years, particularly in areas of high winds and heavy snowfall in western Canada and Scandinavia. Tree toppling became a major problem in the 1980s when seedling production shifted from field to container-grown trees. Poor root regeneration and stability led to the development of copper-treated containers and later to air-pruning propagation trays and pots. Most forest seedlings are grown from seed so root initiation has not been a problem, whereas root architecture in containers and root regeneration after transplanting are of concern (Johnson, 1996).

Initiation of roots is a primary factor for selection of plants in large-scale nursery production. In recent years superior selections of shade trees, particularly oaks (*Quercus*), are being grown from cuttings. Clonal propagation from cuttings eliminates the variability associated with seed-grown trees and provides very uniform landscape plantings. Growing trees from cuttings is not without problems with root initiation and development being of concern to many growers.

## CHEMICAL TREATMENTS TO IMPROVE ROOT INITIATION

There are numerous types of root-promoting chemicals currently on the market. Indole-3-butyric acid (IBA) is the primary root hormone that is available in liquid and talc-based formulations. Liquid IBA products are available in either alcohol or water. Alcohol formulations are rapidly absorbed by cuttings when the quick-dip method is used, whereas the potassium salt of IBA dissolved in water is used on plants sensitive to alcohol. In commercial formulations like Dip 'N Grow, naphthalene acetic acid (NAA) is formulated with IBA to improve root formation. Talc formulations are used when very high concentrations of IBA and NAA are needed for difficult-to-root species without burning the cutting (Dirr and Heuser, 1987). Double Dip hormone treatment is used on difficult-to-root plants where the cutting is quick dipped in a liquid formulation and then treated with a talc formulation to provide a residual amount of hormone for better rooting (Jones, 2004).

An alternative to this is to dilute products like Dip 'N Grow, Woods Rooting Compound, or C-Mone in a gel prepared from dissolving carboxymethylcellulose (CMC) in water to the consistency of thick motor oil. The CMC is a thickening agent used in food products like salad dressings and ice cream. By using a gel preparation, you can use a lower concentration of IBA/NAA because more gel is present on the cut-

ting than when you use plain water. A lower concentration of IBA/NAA is less likely to burn cuttings, especially if you wound. Gel dilutions are very stable, keeping IBA concentrations constant throughout the day when in use and preventing degradation when stored. The author has been very successful rooting camellias with this method. Blythe and Sibley (2005) found this method resulted in more roots per cutting on *Hibiscus syriacus*.

Other additives to rooting hormones reported to increase root initiation are DMSO (dimethyl sulfoxide), PEG (polyethylene glycol), and DMF (dimethylformamide). However, care must be taken when using these additives because they increase toxicity (Dirr and Heuser, 1987). Vitamin K<sub>3</sub> (menadione) is also reported to be synergistic with IBA for rooting hardwood cuttings of *Prunus* species (Christov, 1995).

Chemical pretreatments to improve root initiation include soaking cuttings in plain water overnight under refrigeration to leach out endogenous root inhibitors. This can be a very successful technique for native azaleas. Another technique used to increase rooting for plants high in phenolic compounds and peroxidase enzymes is to dip or soak the lower end of cuttings in ascorbic acid dissolved in water at a concentration of 1.7%–2.5%. Soaking time ranges from a few minutes to several hours depending on the plant and the diameter of the cuttings. The author soaks a difficult-to-root camellia cultivar 'Frank Houser' in a solution of 2.5% ascorbic acid for 1–2 h and increases the percent rooting and number of roots by 50%. Camellias are high in phenolic compounds that counter the effect of auxin. This technique is also effective for improved rooting of *Stewartia* (Bresko and Struve, 2001) and native azaleas (Cook, 2004).

One of the most effective ways of increasing root initials and improving root structure is the use of copper-treated containers (Crawford, 1998). During the development of Spin Out by Griffin Corporation, Valdosta, Georgia, it was discovered that treated propagation trays would improve the number of roots developing from the stem and callus. It has been suggested that when adventitious roots are pruned early in development, a branching stimulus occurs along the stem thereby increasing root numbers. Unfortunately, pretreated propagation trays are no longer commercially available at this time.

It is well known that amending the rooting substrate with products that increase porosity and air space will improve root development. Products like perlite, vermiculite, coarse sand or gravel, and pumice improve the rooting properties of bark and peat. Incorporating low rates of controlled-release fertilizer in rooting media will improve root growth and overall health of the cutting when ready to transplant.

Research by Scagel et al. (2003) suggest that incorporating inoculum of the vesicular-arbuscular mycorrhizal fungus (VAMF) *Glomus intraradices* in the rooting substrate increased root number and growth of *Taxus × media* 'Hicksii'. In order to determine the benefits of VAMF, small-scale trials are necessary to determine the VAMF species required for the particular plant species you are growing.

Another soil amendment with biological activity to improve root numbers and growth is meadowfoam seedmeal marketed as AlbaAide (Deuel and Linderman, 2004). Meadowfoam seed (*Limnanthes alba* Benth.) is produced in Oregon for its oil. After the oil is extracted, the seed meal remains as a waste product. Uses for the seed meal have been explored for the last several years and include liverwort control in nurseries, improved potato production, and improved plant growth. Recent work by the U.S.D.A. Forest Service in Oregon has shown remarkable growth ef-

fects on forest seedlings when seed meal is incorporated in the growing substrate at 1%–5% by weight. Research showed that water extracts of the seed meal were more active than IBA for root promotion. Additional research is needed to determine the full potential benefits for rooting cuttings.

### PHYSICAL TREATMENTS TO IMPROVE ROOT INITIATION

Physical manipulation of cuttings can have a profound effect on the development of roots. Wounding the cutting is a standard nursery practice to stimulate cell division and for better absorption of rooting compounds. There are three types of wounding: (1) scraping one side of the cutting 2.5 cm (1 inch) from the base, (2) scraping the opposite sides of the cutting, and (3) a split wound. The first two are the most common types and are very beneficial for certain types of *Camellia*, *Magnolia*, *Ilex*, *Juniperus*, *Rhododendron*, and *Thuja*. Cuttings of conifers like Leyland cypress are wounded when the needles are stripped from the base of the cuttings (Dirr and Heuser, 1987; Remmick, 1993).

The use of air-pruning containers has gained popularity among tree growers in the last few years as a way to manipulate root growth and eliminate root circling. Manufacturers have developed rooting trays incorporating air-pruning technology to improve the root structure of cuttings and liners (Appleton, 2001). Root initials and root branching are increased when these containers are used. There are several brands of air-pruning propagation tray available including RootMaker, Accelerator, Proptek, and Jiffy. These products have undergone many design improvements since first introduced and are currently the best container devices for rooting and seeding trees. It is necessary to remove trays from the mist area before excess aerial roots and root bridging between cells occurs.

There are differences in opinion whether to root cuttings in full sun or in shade. Most growers use shade because it provides a cooler rooting environment, which is beneficial in the Southern U.S.A. In the last few years, new types of colored shade cloths have come on the market to enhance plant growth in certain ways depending on the color used (Shahak, 2001). The author has been using 50% red shade cloth for rooting and growing camellias. According to the manufacturer, red light enhances root initiation and growth. I can speak from personal experience that it does enhance plant growth. My camellias are about 20% larger than plants grown under black cloth and magnolias from seed are nearly two times larger than plants grown outside under tree shade. Deciduous native azaleas rooted in 2.5 months and have a good growth flush 4 months after sticking.

### STOCK PLANTS

It is known that plants in good nutrition will root better than plants under poor nutrition. Excess nitrogen applied to stock plants stimulates growth, but cuttings from these plants have lower rooting potential. Good balanced nutrition is the general rule, although good boron fertility is correlated to cuttings that root better. Since native soils in the Southeastern U.S.A. are deficient in boron and it is easily leached, improved boron nutrition may result in cuttings with improved rooting potential (Hartman et al., 2002).

Age of stock plants can be a critical factor for maintaining good rooting potential of cuttings. Young, juvenile plants are best for obtaining cuttings, especially hard to root trees and conifers. Timber companies that grow superior clones of pines from

cuttings maintain stock plants as short hedges 0.6 m (2 ft) tall to sustain juvenility for several years. Hedges are replaced every 7–10 years when rooting potential declines (Hartman et al., 2002).

Etiolation is a practice to produce elongated stems in darkness to improve rooting potential. Although this is a proven way to improve rooting, it is not practical for commercial nursery production.

Other factors that can have an effect on root initiation are time of year cuttings are taken, lateral vs. terminal branch cuttings, photoperiod requirements, the use of bottom heat, and the use of mist or fog in the rooting area.

Table 1 is a recipe for rooting oaks. On the left are recommendations by Durr (1997) and on the right are steps that can be taken to improve root initiation of trees and conifers that have problems initiating roots.

**Table 1.** Techniques to improve rooting of oaks.

Durr (1997) Recommendation	Summary Steps to Improve Root Initiation
Collect cuttings from juvenile plants	Good boron fertility
Collect firm-wooded terminal cuttings from 1st flush	Wound
Treat with 10,000 ppm quick dip	“Double dip” hormone treatment or use a gel formulation
Stick in 3 perlite : 1 peat (v/v) medium	Incorporate mycorrhizal fungi and/or controlled release fertilizer; use air-pruning propagation trays
Maintain under intermittent mist	Bottom heat if irrigation water is cold or during winter rooting
Shadehouse	30%–50% red shadecloth

## LITERATURE CITED

- Appleton, B.** 2001. Pots: Past and future; Containers now provide more functions than holding media and roots. *NMPro* 17(10):71–76.
- Blythe, E. K., and J. Sibley.** 2005. Use of a thickening agent for application of auxin to cuttings of hibiscus and rose. *Proc. South. Nursery Assoc. Res. Conf.* 50: In Press.
- Bresko, K. and D. Struve.** 2001. Following protocol. *Amer. Nurseryman* 197(2):72–74.
- Christov, C. and A. Koleva.** 1995. Stimulation of root initiation in hardwood sweet and sour cherry rootstocks. *Bulg. J. Plant Physiol.* 21(1):68–72.
- Cook, A.** 2004. Personal communication—Rooting native azaleas. Valdese, North Carolina.
- Crawford, M.A.** 1998. Multiple uses of Spin Out in the nursery and landscape. *Comb. Proc. Intl. Plant Prop. Soc.* 48:627–631.
- Deuel, W. and R. Linderman.** 2004. Research Update: Douglas Fir. <[www.meadowfoam.com](http://www.meadowfoam.com)>.
- Durr, M. A.** 1997. The oak propagation paradigm. University of Georgia, Athens, Georgia.
- Durr, M. A. and C. W. Heuser, Jr.** 1987. The reference manual of woody plant propagation: from seed to tissue culture. Varsity Press, Inc., Athens, Georgia.
- Hartmann, H.T., D.E. Kester, F.T. Davies, Jr., and R.L. Geneve.** 2002. *Hartmann and Kester's plant propagation: Principles and practices.* 7th ed. Prentice Hall, Upper Saddle River, New Jersey.
- Johnson, F.** 1996. Using chemicals to control root growth in container stock: A literature review. NEST Technical Report TR-026, Ontario ministries of Nat. Res., <[www.bo-realscience.on.ca](http://www.bo-realscience.on.ca)>.

- Jones, S.D.** 2004. A brief discussion of rooted cutting propagation at Mitsch nursery with focus on conifers. *Comb. Proc. Intl. Plant Prop. Soc.* 54:434–438.
- Remmick, M.D.** and **T. Bilderback.** 1993. Split wounding of stem cuttings. *Proc. South. Nursery Assoc. Res. Conf.* 38: 289–291.
- Scagel, C.F., K. Reddy,** and **J.M. Armstrong.** 2003. Mycorrhizal fungi in rooting substrate influence the quantity and quality of roots on stem cuttings of Hick's Yew. *HortTechnology* 13:62–66.
- Shahak, Y.** 2001. Colored shade nets—A new agro-technology. <[www.polysack.com](http://www.polysack.com)>.

---

## Optimizing the Water Relations of Cuttings During Propagation®

**Fred T. Davies, Jr.**

Department of Horticultural Sciences, Texas A&M University, College Station, Texas 77843–2133

### SO, HOW DO CUTTINGS GAIN AND LOSE WATER?

It is important to remember that water is the universal solvent. It brings minerals from the roots for biosynthesis within the leaf. About 1%–2% of water utilized is needed for photosynthesis and plant growth, while the remaining 98% of water is lost to transpiration and the subsequent cooling of leaves. Evaporative cooling occurs during transpiration as water passes from a liquid to gaseous phase (vapor). Transpiration is the “engine” that pulls (lifts) water up from the roots. Unlike people, who can move and find a more comfortable location, a plant lacks mobility, so it needs to do its best to reduce the heat load, which it does through transpiration. There is tremendous pressure (tension) that occurs in the top of a 100 m (300 ft) redwood tree (*Sequoia*) in the movement of water from the roots into the tops of these tall trees. The pressure in the xylem (part of the plumbing system of the plant) can exceed 250 psi, which is some 18 times greater than atmospheric pressure. The lifting of water occurs through transpiration and the process of cohesion with the hydrogen bonding of water molecules. This gives a column of water tremendous tensile strength, i.e., as strong as metal.

### ENVIRONMENTAL FACTORS AFFECTING TRANSPIRATION

There are three environmental factors that effect transpiration: light, temperature, and humidity.

Light causes plants to transpire more rapidly, stimulates the opening of the stomata (Fig. 1) and warms the leaf. Temperature increases transpiration since water evaporates more quickly. A 20 °F (10 °C) increase in temperature will cause a 3-fold increase in transpiration. Humidity affects the diffusion of water as a vapor from the leaf through the stomata into the surrounding drier air. Water travels from a high potential (saturated internal leaf cavities) to a lower potential (unsaturated, drier) surrounding air outside the leaf (Fig. 1).

### VAPOR PRESSURE DEFICIT (VPD)

Vapor pressure is determined by temperature and relative humidity (RH). The vapor pressure deficit (VPD) is the gradient measured as difference between the

- Jones, S.D.** 2004. A brief discussion of rooted cutting propagation at Mitsch nursery with focus on conifers. *Comb. Proc. Intl. Plant Prop. Soc.* 54:434–438.
- Remmick, M.D.** and **T. Bilderback.** 1993. Split wounding of stem cuttings. *Proc. South. Nursery Assoc. Res. Conf.* 38: 289–291.
- Scagel, C.F., K. Reddy,** and **J.M. Armstrong.** 2003. Mycorrhizal fungi in rooting substrate influence the quantity and quality of roots on stem cuttings of Hick's Yew. *HortTechnology* 13:62–66.
- Shahak, Y.** 2001. Colored shade nets—A new agro-technology. <[www.polysack.com](http://www.polysack.com)>.

---

## Optimizing the Water Relations of Cuttings During Propagation®

**Fred T. Davies, Jr.**

Department of Horticultural Sciences, Texas A&M University, College Station, Texas 77843–2133

### SO, HOW DO CUTTINGS GAIN AND LOSE WATER?

It is important to remember that water is the universal solvent. It brings minerals from the roots for biosynthesis within the leaf. About 1%–2% of water utilized is needed for photosynthesis and plant growth, while the remaining 98% of water is lost to transpiration and the subsequent cooling of leaves. Evaporative cooling occurs during transpiration as water passes from a liquid to gaseous phase (vapor). Transpiration is the “engine” that pulls (lifts) water up from the roots. Unlike people, who can move and find a more comfortable location, a plant lacks mobility, so it needs to do its best to reduce the heat load, which it does through transpiration. There is tremendous pressure (tension) that occurs in the top of a 100 m (300 ft) redwood tree (*Sequoia*) in the movement of water from the roots into the tops of these tall trees. The pressure in the xylem (part of the plumbing system of the plant) can exceed 250 psi, which is some 18 times greater than atmospheric pressure. The lifting of water occurs through transpiration and the process of cohesion with the hydrogen bonding of water molecules. This gives a column of water tremendous tensile strength, i.e., as strong as metal.

### ENVIRONMENTAL FACTORS AFFECTING TRANSPIRATION

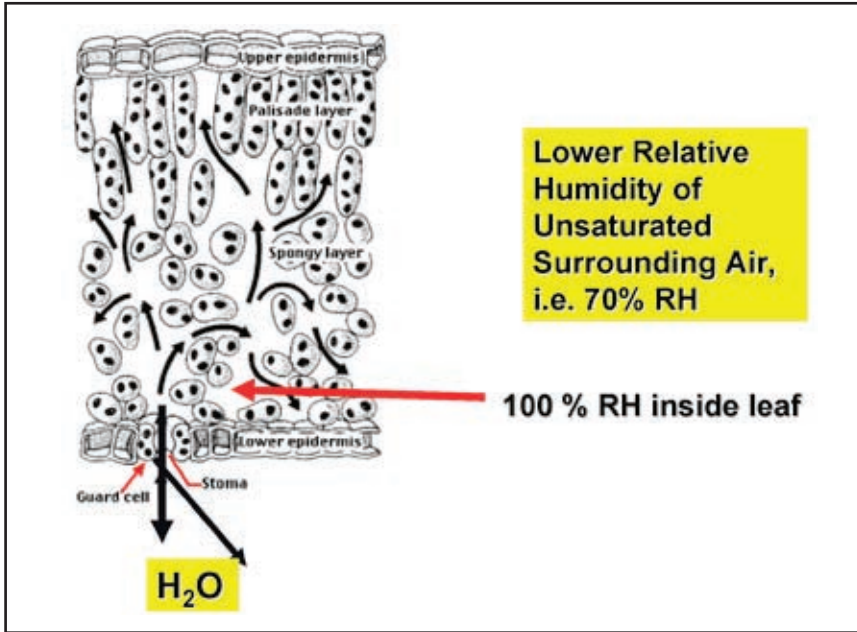
There are three environmental factors that effect transpiration: light, temperature, and humidity.

Light causes plants to transpire more rapidly, stimulates the opening of the stomata (Fig. 1) and warms the leaf. Temperature increases transpiration since water evaporates more quickly. A 20 °F (10 °C) increase in temperature will cause a 3-fold increase in transpiration. Humidity affects the diffusion of water as a vapor from the leaf through the stomata into the surrounding drier air. Water travels from a high potential (saturated internal leaf cavities) to a lower potential (unsaturated, drier) surrounding air outside the leaf (Fig. 1).

### VAPOR PRESSURE DEFICIT (VPD)

Vapor pressure is determined by temperature and relative humidity (RH). The vapor pressure deficit (VPD) is the gradient measured as difference between the





**Figure 1.** Water vapor travels from the saturated leaf cavity to surrounding unsaturated air.

water vapor pressure in leaves ( $V_{leaf}$ ) and surrounding air ( $V_{air}$ ). At 85 °F (29 °C) the air inside the leaf is saturated at 100% RH and has a vapor pressure of 0.60 psi. If the drier air surrounding the leaf has 75% RH, then its vapor pressure is 0.45 psi. Hence, the VPD is 0.60 psi – 0.45 psi = 0.15 psi. The goal in controlling the water relations of cuttings is to reduce the VPD (Hartmann, et al, 2002; Loach, 1988).

### WATER RELATIONS OF CUTTINGS

The water relations of cuttings is a balance between transpirational losses and the uptake of water. Water travels from the soil (propagation medium) through the roots into the stems and into the leaves where photosynthesis and transpiration occurs. Cells must maintain adequate turgor for growth and for initiation and development of adventitious roots. Root meristematic areas also produce a phytohormone, abscisic acid (ABA), which is a chemical signal for drought. As the surrounding soil (medium) dries, ABA travels through the xylem from the roots to leaves and causes the guard cells to collapse, which closes the stomata and helps to regulate the loss of water.

### THE PROBLEM

Since cuttings initially do not have roots, they can't produce ABA to control water loss and lack effective organs to replace transpired water lost. Cuttings take up water poorly through the base of the stem — until adventitious roots are formed. The cutting base and any foliage immersed in the propagation medium are main entry points of water until adventitious roots form (Loach, 1988).

Water absorption through leaves is not a major source/contributor of water balance. Water uptake in cuttings and tissue relative water content (RWC) [helps de-

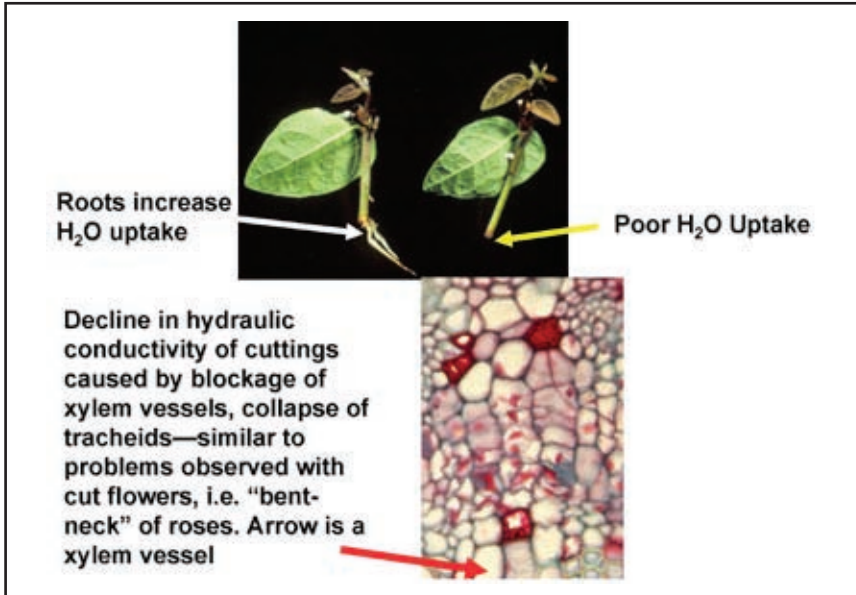


Figure 2. New adventitious roots increase water uptake.



Figure 3. Intermittent mist forms water droplets with an average size  $> 50 \mu\text{m}$  and a range of  $50$  to  $100 \mu\text{m}$ . Water from mist condenses and forms a film of water on leaf surface. Water evaporates from the leaf surface rather than from internal water in the tissue.

terminer actual water in tissue] declines after cuttings are initially inserted into the propagation medium. There can also be a decline in hydraulic conductivity of cuttings caused by blockage of the xylem vessels and a collapse of tracheids (part of the plumbing system of the plant). This is similar to blockage problems that occur in cut flowers, i.e., "bent-neck" of roses (Fig. 2).

It is important to maintain hydraulic contact between the cutting base and propagation media — thus improving water uptake of cuttings. Wounding increases the contact area between cutting base and propagation medium for more optimum water uptake of cuttings.

### CONTROL OF WATER LOSS IN CUTTINGS

Intermittent mist is the most common system for propagating cuttings (Fig. 3). Mist is composed of water droplets that average  $>50 \mu\text{m}$ , and have a size range of  $50$



**Figure 4.** Fog systems form fine water droplets with an average size of 15  $\mu\text{m}$ . Fog has a high surface: volume ratio, which helps water remain suspended in air as a vapor (gas) to maximize evaporation. Fog does not condense, avoids over-saturation of media and foliar leaching, which occurs with mist.

to 100  $\mu\text{m}$ . The mist condenses and forms a film of water on the leaf surface. Water evaporates from the leaf surface rather than from internal water in leaf tissue.

Mist decreases  $V_{\text{leaf}}$  by reducing leaf temperature and causes a modest increase in  $V_{\text{air}}$  by increasing the RH. Mist lowers the leaf to air VPD or vapor pressure gradient and slows down transpiration of the cutting leaf surface.

There are some inherent problems with intermittent mist. Mist rapidly leaches cuttings of nutrients such as nitrogen, phosphorus, potassium, and magnesium, with losses as high as 60% or more within the first week (Hartmann et al., 2002). Water condenses from mist, which can saturate the propagation medium, reducing aeration and creating an anaerobic condition that can lead to poor rooting and death of cuttings. The evaporative cooling of mist can also lead to suboptimal propagation medium temperatures, which is why bottom heat is sometimes used in indoor and outdoor mist propagation systems.

## FOG SYSTEMS

Fog produces fine water droplets that average around 15  $\mu\text{m}$  (Fig. 4). Fog has a high surface to volume ratio that allows it to remain suspended in air as a vapor (gas) to maximize evaporation. Fog does not condense, which avoids the over-saturation of medium and foliar leaching that occurs with mist.

Fog maximizes the  $V_{\text{air}}$  by increasing the RH of the surrounding air. Fog also decreases  $V_{\text{leaf}}$  by decreasing leaf and air temperature. It lowers the leaf to air VPD and slows down transpiration.



**Figure 5.** Contact systems and nonmisted enclosures reduce water loss from foliage. Condensation increases the relative humidity of the air. They are simple, inexpensive and cost-effective. Minimal condensing occurs and over-saturation of media and foliar saturation of media and leaching is avoided, which occurs with mist. Temperature control is critical.

Problems with fog systems include high costs and high maintenance requirements — including clogging and wearing out of nozzles. Filtration/deionizing systems are required to remove any salts from the water supply.

### CONTACT SYSTEMS/NONMISTED ENCLOSURES

Contact systems and nonmisted enclosures reduce water loss from foliage, and the condensation increases the relative humidity of the air (Fig. 5). These systems are simple, inexpensive, and cost-effective. There is minimal condensing, which avoids the over-saturation of media and foliar leaching that occurs with mist. This system works well with hardwood and semihardwood cuttings of difficult-to-root species that require longer propagation times.

Contact systems/nonmisted enclosures maximize  $V_{\text{air}}$  by preventing the escape of water vapor. The system predominately uses humidification since only  $V_{\text{air}}$  is affected. The  $V_{\text{leaf}}$  is somewhat affected, particularly when the leaf temperature is cooler with the condensation that occurs in the contact poly system. It lowers the leaf to air VPD and slows down transpiration. While inherently cheaper, there are problems with contact systems/nonmisted enclosures. It is critical to control irradiance and subsequent heat load via shade and temperature control. The system easily traps heat via light irradiance, which can adversely increase the VPD by reducing RH of air and increasing the air and leaf temperature.

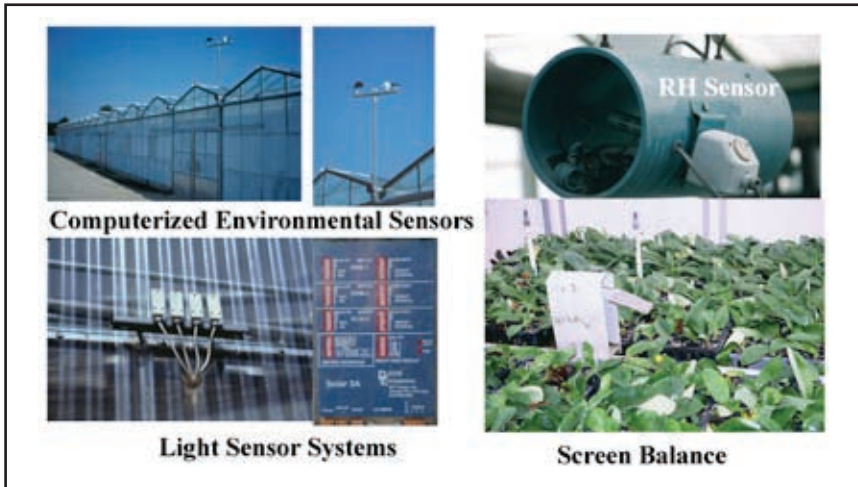
### STATIC MIST CONTROL SYSTEMS

Static mist systems are the most common way of controlling mist. They are relatively inexpensive, easily installed, and rely on clocks and timers (Fig. 6). However, they are unable to automatically respond to daily fluctuations in light irradiance, cloud cover, RH, temperature, or stage of root development. Under moderate conditions they reduce evaporative demand by reducing VPD. However under cloudy days when solar radiation is low, too much mist is applied. Conversely, on very sunny, windy days when net radiation is high, too little mist is applied.





**Figure 6.** Static mist control systems rely on clocks and timers. They are unable to automatically respond to daily fluctuations in light irradiance, cloud cover, relative humidity, temperature, or stage of root development.



**Figure 7.** Dynamic mist control systems respond to changes in the environment affecting vapor pressure deficit. Evapotranspiration-based mist control systems (dynamic control) can respond to changes in air temperature, time interval between misting and calculated vapor pressure deficits between the leaf and surrounding air.

### DYNAMIC MIST CONTROL SYSTEMS

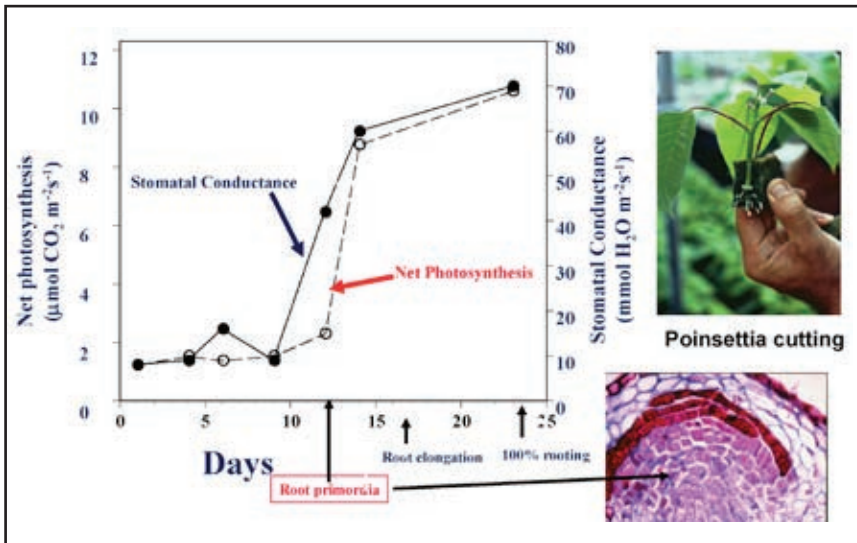
Dynamic mist control systems respond to changes in the environment affecting VPD (Fig. 7). There are evapotranspiration-based mist control systems of dynamic control, which are based on air temperature, the time interval between misting, and calculated  $VPD_{air}$  (Hartmann et al., 2002; Wilkerson et al., 2005). These systems can also be regulated by net solar radiation and relative humidity. They are much more responsive to the changing environmental conditions.

### IDEAL PROPAGATION MEDIUM

The ideal propagation medium has an air filled porosity of 15%–40%, with 20%–25% considered to be optimal. The ideal water holding capacity (WHC) has a range of 20%–60%, after gravitational drainage. Nonetheless there is no one universal commercial propagation medium. It is important to have good water drainage for sufficient aeration and sufficient WHC to maintain adequate hydraulic contact between the cutting base and propagation medium.



**Figure 8.** It is important to maintain the plant’s momentum by collecting during optimum seasonal rooting and early in the day before plants become stressed. Storage under low light, high RH and cooler temperatures helps to alleviate vapor pressure deficit.



**Figure 9.** Keep light levels low until cuttings start to show visible roots (Svenson et al., 1995).

**STOCK PLANT MAINTENANCE AND MAINTAINING THE PLANT’S MOMENTUM**

It is important to maintain stock plants that are nutritionally fit and under optimal irrigation regimes. It is also important to maintain the plant’s momentum by harvesting cuttings during the season of the year when maximum rooting occurs, to reduce the propagation time under mist.

Cuttings should also be collected early in the day when plant water status is optimum to minimize any stress to the cuttings, i.e., low VPD (Fig. 8). Storage under low light, high RH, and cooler temperatures helps to control VPD.

During the initial week or two of cutting propagation, it is not necessary to maintain high light conditions under mist. In a study with poinsettia, relative water content, xylem water potential, net photosynthesis, and stomatal conductance were initially low with unrooted cuttings (Svenson, et al., 1995). Only when cuttings started to form root primordia and adventitious roots first became visible did stomatal conductance and net photosynthesis start to increase (Fig. 9). The take home message is that prior to visible roots — keep light levels low to reduce VPD. When roots start to form, increase the light so plants can take advantage of higher photosynthetic rates to improve root development and production of rooted liners.

### SUMMARY OF OPTIMIZING WATER RELATIONS OF CUTTINGS

- Maintain the plant's momentum by propagating during optimum rooting periods, collecting cuttings early in the day and minimizing plant stress.
- Control stress — light, temperature, and humidity (RH) — to reduce VPD, i.e., an atmosphere of low evaporative demand decreases transpirational losses from cuttings.
- Don't increase light until cuttings start to form adventitious roots.
- Apply just enough mist to form a thin film of water on leaf surface.
- Use a loose propagation medium for proper aeration.
- Group cuttings in propagation by species requirement for moisture, i.e., zelkova and Chinese elm have a lower tolerance for mist and saturated propagation medium than river birch (Johnson, 2004).

### LITERATURE CITED

- Hartmann, H.T., D.E. Kester, F.T. Davies, Jr., and R.L. Geneve. 2002. Hartmann and Kester's plant propagation: Principles and practices. 7th edition. Prentice Hall, Upper Saddle River, New Jersey.
- Johnson, E. 2004. Plant water relationships for woody ornamental crops. *Comb. Proc. Intl. Plant Prop. Soc.* 54:566–572.
- Loach, K. 1988. Water relations and adventitious rooting, p. 104–116. In: T.D. Davis, B.E. Haissig, and N. Sankhla (eds.). *Adventitious root formation in cuttings*. Dioscorides Press, Portland, Oregon.
- Svenson, S.E., F.T. Davies, Jr., and S.A. Duray. 1995. Gas exchange, water relations, and dry weight partitioning during root initiation and development of poinsettia cuttings. *J. Amer. Soc. Hort. Sci.* 120:454–459.
- Wilkerson, E.G., R.S. Gates, S. Zolnier, S.T. Kester, and R.L. Geneve. 2005. Transpiration capacity in poinsettia cuttings at different rooting stages and the development of a cutting coefficient for scheduling mist. *J. Amer. Soc. Hort. Sci.* 130:295–301.



## Educating the Next Generation of Propagators<sup>®</sup>

### Ozzie Coor

Coor Farm Supply, P.O. Box 525, Smithfield, North Carolina 27577

Good morning and welcome to Gainesville!

To Seek and To Share — the motto of IPPS. This motto is the foundation of my presentation today. As we reach the first half of the first decade of the twenty-first century, I offer this challenge: (1) let us do our very best to educate the next generation of plant propagators, and (2) let us inspire these young people to a level above and beyond our own.

To achieve this objective, we must be steadfast and untiring. The future of plant propagation rests in our hands and, ultimately, in the hands of those we teach in the coming days, weeks, months, and years. The road to successful education should be never-ending, and room must be reserved to broaden this road and to keep the flow of information moving forward.

There are two main lanes in this road to the education of the next generation of propagators: one is the formal education, while the other is practical experience acquired from areas other than formal education — such as on-the-job learning and knowledge gained from self determination. Formal education is the transfer of knowledge from teacher to student. Most students begin their plant propagation learning, on a course basis, in junior high or high school. Organizations such as 4H and Future Farmers of America have been influential in this endeavor.

The next level of learning is community college or technical college; these institutions offer many fine horticulture programs across the country. Indeed, several members of this group are graduates of these community college programs.

University programs finish out the formal education part of the educational road. Some programs include a 2-year course of study offering an associate degree. Further educational opportunities exist with degrees being awarded at bachelor's, master's, and doctoral levels. Public and private institutions offer programs in horticulture, not the least of which includes plant propagation.

Now, how can you aid in this area of formal education? Perhaps you can volunteer to teach a propagation class at your local high school or be a guest lecturer at a community college or even a university. Maybe a field trip to your nursery would provide meaningful information to students. Some institutions require or at least encourage summer work-study experience for their horticultural programs. For propagators, the opportunity to serve on an advisory panel of an educational institution may be a possibility. Propagators should not be timid if you wish to share your knowledge with those in the business of giving our next generation of propagators a formal education. Likewise, you educators need to seek out the seasoned nurserymen for their inputs and ideas. All of us will be beneficiaries of these efforts. Nurserymen, I urge you to make the most of these opportunities! You just might have a great employee some day. Who knows — you might learn something yourself!

Financial assistance is another way you can help. A donation of plant material is a possibility. Horticultural scholarships endowed by you individually or by your nursery could help promising students in need.

Another important lane in the road to education of the next generation of propa-

gators is the knowledge gained by hands-on experience. This knowledge can be acquired working for large multi-state nurseries or any size operation down to small, backyard, hobby nurseries. Opportunities for education in plant propagation can exist across the entire spectrum of the industry. With proper motivation and a measure of inspiration, propagators new to the discipline have a chance to learn from many older generation propagators in the “school of hard knocks.”

How can we, the old guard, assist these new propagators? First, we need to remember that plant propagation is an art, as well as a science. Every single one of us has been brought to our knees in our quest for success. After such an experience, we should be humbled and should realize our fallibility. Just teaching the new kids on the block that success is not guaranteed is a substantial undertaking. If you have an interested person working for you, or with you for that matter, let them know you are interested in their quest. Remember, you were in their shoes once upon a time.

The assistance you offer can be of various types. Perhaps you can offer hints on ways to organize their efforts more efficiently, thus increasing total production. Another way to help might be guidance in propagating a plant that is giving the new propagator fits. Your donation of information might be what it takes to transform failure into success. A donation of cuttings may be another way you can help.

The tricks of the trade have helped many of us over the years. I remember Bill Barr helping me years ago with *Nandina domestica*, and I have the notes on my office wall to this day. We need to write these little tricks of the trade down for the next generation of propagators and generations to come. How many tricks of the trade have been silenced because the holder never wrote them down before he or she passed on? As far-fetched as it sounds, perhaps a clearinghouse for these ideas is in order sometime in the future. In addition to preserving this information, it is our responsibility to disseminate it.

Our imaginations are the only limitations we have as we educate the next generation of propagators. With determination, let us reiterate the challenge that began this presentation: (1) let us do our very best to educate the next generation of plant propagators, (2) let us inspire these young people to a level above and beyond our own, and (3) remember the IPPS motto — “To Seek and To Share.”

**Acknowledgement.** I thank the following individuals for their assistance: Johnny Capps, North Johnston High School, Kenly, N.C.; Bill Scott, Lenoir Community College, Kinston, N.C.; Angie Cummer, Fayetteville Technical Community College, Fayetteville, N.C.; Phil Beaumont, Johnston Community College, Smithfield, N.C.; Dr. Frank Blazich, North Carolina State University, Raleigh, N.C.; Bob Black, Bennett’s Creek Nursery, Suffolk, VA.; Sean Gurkin, Old Courthouse Nursery, Warsaw, NC; Janet Hutson, Magnolia Gardens Nursery, Waller, TX; Charlotte LeBlanc, Imperial Nurseries, Quincy, FL; and Lanny Thomas, Swift Creek Nursery, Clayton, N.C.

## Propagation Decisions in a Fluid Market®

**Jim Berry**

Plant Development Services, Inc. (PDSI), P.O. Box 670, 17325 County Road 68, Loxley, Alabama 36551

### INTRODUCTION

My friends John and Carol recently bought their first home in a very nice section of Dunwoody, Georgia, close to Atlanta. The home was dated but was large and beautiful. The landscape also was very 1985! The corners were marked by two over-trimmed Nellie R. Steven hollies. The foundation plantings had over-trimmed *Cleyera* and *Ilex cornuta* 'Compacta'. The landscape sorely needed a makeover. I thought that the family who sold the home and the family who purchased the home would not want these three ornamentals in their next landscape.

Close to my home is an upscale golf community, which was started 10 years ago. Landscapes for those homes older than 5 years are basically green and boring, with a limited plant palette of holly, crepe myrtle, and maybe a groundcover juniper. Newer homes contain a vast number of species and lots of color, and the total effect is that of a garden, not a landscape. These homeowners use mixed color, tropical vines, tropical foliage, shrub roses, flowering hardy shrubs, and good basic woody ornamental plants — that has created year round color.

These examples illustrate the fact that the green goods market is fluid. When fluid is an adjective it means that the market is subject to change, variable, and dynamic. While the fluidity shows up in consumer landscapes, it starts with us — the propagators. Unless you are a propagator for less than 1 year you know the market is fluid and always changing.

I have been told that a very large and historic nursery in Semmes, Alabama, in the early days primarily produced boxcar loads of *Ligustrum sinense*, the common Chinese privet. Today the demand for that plant is totally flat. In my 30-year nursery career I can list numerous ornamental plants that were once popular but no longer favored in market, i.e., *Pyracantha*, *Photinia*, and *I. fortunei* 'Rotunda'. I produced hundreds of thousands of these items in the 1970s and 1980s. Somewhere along the way, consumers lost their interest and desire for the once commercially viable species.

Other examples of the fluidity of the market include ornamental grasses and perennials — both significant economic product classes in the green sector of the plant industry. I am one of many propagators who have experienced the year-to-year fluctuation of the pampas grass, variegated privet, and the *Elaeagnus* market. In the 1960s and 1970s, ornamental grass was basically pampas grass. Today the product class is huge. Specialty ornamental grass nurseries commonly list many, many species — and each species may offer several individual cultivars.

Perennials were not mainstream product classes in the 1980s. Now nearly every nursery produces and sells perennials as the trend has been established and mainstreamed. The market is constantly changing.

In short periods of time Grandiflora Nursery, AgriStarts, and It's Saul Plants have developed large businesses solely growing the innovative and the new. Bracey's and

Chestnut Hill Nursery began as producers of small fruit-container growers and now are identified with other ornamental nursery products.

The most recent proof of the fluid market is the modern day practice to promote and advertise new plants to the end-consumer, creating instant market changes. Lead by Anthony Tessler's mass marketing of the Flower Carpet Roses, this trend has been followed by similar consumer oriented marketed brands such as the Encore Azalea®, the *Hydrangea macrophylla* Endless Summer® hydrangea, and Proven Winners. Branding is changing the marketplace more rapidly now than ever before.

### **I HAVE SEVERAL THOUGHTS THAT MIGHT BE HELPFUL TO PROPAGATORS IN COPING WITH THE MARKET CHANGES**

- 1) Propagators should anticipate a market change in product of 10%–15% per year. The nurseries where I have my experience probably would tell you that over the last 10–15 years their product mix has changed 85% and probably should have changed 100%. Seedling *Ternstroemia japonica* (syn. *T. gymnanthera*) (Japanese cleyera) has been replaced by cultivar selections. Single-season flowering azaleas have been replaced with important, multi-season flowering cultivars. Shrub roses are now important, whereas before they were not. The same could be said about ornamental grasses, perennials, and numerous other product classes.
- 2) Another belief I have is that when the consumer preferences change, it happens very quickly. One specific dilemma I experienced was the death of the Chinese holly market. For 20 years our company produced and sold about 100,000+ units per year. At any one time we could have 100,000 ready to sell, 100,000 planted for next year, and 100,000 liners for the next crop. One year we only sold 15,000, the next year 5,000, and then we could not give them away. When a product line dies in the market, propagators need to have the courage to quickly, severely, and sharply reduce propagation — otherwise their economic damage will be greater. The opposite is also true. When a new product is accepted, the growth of the new market is extremely rapid.
- 3) Propagators need to have their feelers out as to where the market is going. Have you made inquiries to see if you can legally participate in the propagation and or production of hot product classes such as Knockout® roses, Encore Azaleas®, Endless Summer® hydrangea? You should be aggressive in seeking licenses or finding ways to cooperate with these successfully promoted products. You may not always succeed but at least you tried. Without the effort you are guaranteed to miss the opportunity.
- 4) Be aware and be alert as a propagator. Propagators need to read and listen to the media and influential horticulturists to sense the market changes. If I hear of a new plant four times over the course of the year, I sense a potential opportunity. I investigate, am proactive, and not consistently reactive to the current market.
- 5) Beware that new plant buzz often has no commercial value. Just because the plant nut crowd is excited and talking about some-

thing does not mean that you can efficiently produce the new plant, much less sell it. I have been hooked before, most recently by evergreen hydrangea!

- 6) Often the worst source of advice to propagators comes from last year's market. It is tempting to obtain the sold material list of last year from your very biggest customer. If you let that information drive your propagation schedule and you are a shrub grower, here are the implications:
  - a) So you got the list of last year's sales from "Big Box Bertha" at the beginning of the propagation season. What is noticeable is the large numbers of commodities in the top 50 items, plus the list is validated in your mind with a couple of very hot branded products. You quickly jot down new production numbers to which you will propagate this season. You will plant those numbers next spring and you will sell from that mix the following fall and spring. Without thought you have grown the perfect product mix for the fluid market 42 months too late — 3.5 years late! Do you need reminding that the market changes, in my opinion, at 10% to 15% per year? If so, your product mix is about 35%–52% off target.
  - b) I am one to keep records of sales for 3 years for each plant and to analyze trends. I will decide on propagation numbers after I ask several questions: (1) am I selling this item at discount prices to move volume, (2) are the plants selling out at good prices at a young age, and (3) did I turn down orders on this plant?
- 7) The larger the nursery the more necessary it is to have multiple staff giving input into the propagation plan. Be selective in who those employees are. Consider that sales staff can be too likely to promote items that historically sold, or have had previous demand. Sometimes the economy of production of some items is exceptionally poor. Shortages of some items may be because no one can produce them profitably or for technical reasons.

Growers are known to want to grow items that are very easily grown and that cause no problems in production.

Every decision must be made based on economics. Ask yourself: "can I grow the plants and make a profit...which plants return more on investment, considering propagation efficiency, production cost, and selling price?"

If you are consulting with several staff when making propagation decisions, be sure that there is a leader who can anticipate the market changes, so your product mix can move along in the right direction. Along with input of others, that leader must express wisdom and intuition in making final decisions. Vision and intuition are vital in planning new crops and are generally met with resistance by most of the staff.

I am convinced that the market is changing at an ever-increasing and rapid pace. I believe what the statistics underline: that the shrub market share is shrinking in relationship to trees, color, and perennials. Are you and I anticipating where the market is going? Are you and I still clinging to past markets? Are you and I aggressively jumping on the bandwagon when a new product is hot, hot, hot? Are you and I reactive or proactive? Reactive can be both good and bad!

## SUMMARY

I conclude with these thoughts: I want to sell young expensive plants; I do not and cannot sell over-sized, undervalued plants. Additionally, selling young plants, in most cases, is profitable. I only grow commodities if I am the lowest cost producer. Geographic advantages, climatic advantages, and low cost of production allow me to compete and win in the commodity markets.

It is critically important to know that I have propagated noninvasive cultivars. Also critical to me is that what I propagate performs in the nursery, the market, and the landscape. What level of ethics do you maintain when determining the propagation schedule?

As our industry has matured, we are definitely in the mainstream of consumerism. We compete with other hobbies and other leisure necessities for the consumer dollar. We must take notice that the modern consumer wants style, value, new and improved qualities in all their purchases, whether that is appliances, fashion, or garden plants — and we must respond to these wants, demands, and opportunities. This is an exciting, yet challenging, time to make good decisions of what to propagate. When you make the right choices, the results will be quite rewarding. Do not be afraid of exercising the influence you have in the marketplace.

---

## Propagation of New Introductions®

**Mark Griffith**

Griffith Propagation Nursery, 2580 Antioch Church Road, Watkinsville, Georgia 30677

## INTRODUCTION

New plants have become the driving force in ornamental horticulture in the 2000s. They provide excitement for the veteran nurseryman to the casual gardener. A new trend, in the slow-to-change nursery business, is to aggressively market our products to the end consumer. The new plants, brand names, colored containers, colored tags, and large timed releases are all part of the equation. The large timed release is where Griffith Propagation Nursery becomes involved. We work with many nurseries and plant patent agents to get the new liner plants to the wholesale growers in sufficient numbers so that they will have a finished product ready for the pre-planned release to the public. It is not uncommon that the quantities required are close to 400,000 liners.

The production of the new plants requires large amounts of space and facilities. In 2002 we purchased an abandoned hog farm that had been idle for 10 years. The 13-ha (32-acre) tract included nine parlors approximately 99 × 12 m (325 × 40 ft) of poured and slated concrete. The property also had three wells and a 3-acre lagoon. The timing of this purchase happened about the same time we began having discussions with nurseries about helping to build numbers on new plants for future production. We decided to devote our new location solely to the production of new products.

On the first pad, which was solid concrete, we built fourteen 6 m × 11 m (20 × 36 ft) propagation houses with bottom and top heat. All these houses have a fine mist system, fans, and shutters. On the second pad we built a 12 m × 99 m (40 × 325 ft) greenhouse with thermostat-controlled side curtains and heaters. This facility is

## SUMMARY

I conclude with these thoughts: I want to sell young expensive plants; I do not and cannot sell over-sized, undervalued plants. Additionally, selling young plants, in most cases, is profitable. I only grow commodities if I am the lowest cost producer. Geographic advantages, climatic advantages, and low cost of production allow me to compete and win in the commodity markets.

It is critically important to know that I have propagated noninvasive cultivars. Also critical to me is that what I propagate performs in the nursery, the market, and the landscape. What level of ethics do you maintain when determining the propagation schedule?

As our industry has matured, we are definitely in the mainstream of consumerism. We compete with other hobbies and other leisure necessities for the consumer dollar. We must take notice that the modern consumer wants style, value, new and improved qualities in all their purchases, whether that is appliances, fashion, or garden plants — and we must respond to these wants, demands, and opportunities. This is an exciting, yet challenging, time to make good decisions of what to propagate. When you make the right choices, the results will be quite rewarding. Do not be afraid of exercising the influence you have in the marketplace.

---

## Propagation of New Introductions®

**Mark Griffith**

Griffith Propagation Nursery, 2580 Antioch Church Road, Watkinsville, Georgia 30677

## INTRODUCTION

New plants have become the driving force in ornamental horticulture in the 2000s. They provide excitement for the veteran nurseryman to the casual gardener. A new trend, in the slow-to-change nursery business, is to aggressively market our products to the end consumer. The new plants, brand names, colored containers, colored tags, and large timed releases are all part of the equation. The large timed release is where Griffith Propagation Nursery becomes involved. We work with many nurseries and plant patent agents to get the new liner plants to the wholesale growers in sufficient numbers so that they will have a finished product ready for the pre-planned release to the public. It is not uncommon that the quantities required are close to 400,000 liners.

The production of the new plants requires large amounts of space and facilities. In 2002 we purchased an abandoned hog farm that had been idle for 10 years. The 13-ha (32-acre) tract included nine parlors approximately 99 × 12 m (325 × 40 ft) of poured and slated concrete. The property also had three wells and a 3-acre lagoon. The timing of this purchase happened about the same time we began having discussions with nurseries about helping to build numbers on new plants for future production. We decided to devote our new location solely to the production of new products.

On the first pad, which was solid concrete, we built fourteen 6 m × 11 m (20 × 36 ft) propagation houses with bottom and top heat. All these houses have a fine mist system, fans, and shutters. On the second pad we built a 12 m × 99 m (40 × 325 ft) greenhouse with thermostat-controlled side curtains and heaters. This facility is



used to produce and hold the stock plants during the winter. Winter production is a necessity in meeting the release dates and quantities. The liners produced in the 14 propagation houses are moved to the heated holding house once they are rooted and the cycle repeats itself. The liners moved to the holding houses also become stock plants. The third pad is an uncovered area used to hold and grow out the liners in the warmer months. The fourth pad is 15 m × 99 m (50 ft × 325 ft) and contains a slated concrete floor system that drains into a 1.5 m (5 ft) pit and returns to the lagoon. This greenhouse has top heat and a heat system that blows the heat into the pit area. A fan system under the floor moves the heat throughout the greenhouse. We use this house to grow 1-gal stock plants throughout the year. The fifth pad is also 15 m × 99 m (50 × 325 ft) and contains the same type floor and heating system as the fourth pad. This greenhouse is used for propagation. This house holds around 150,000 liners.

We constructed a large pad with six 6 m × 22 m (20 × 72 ft) cold frames. We left 8.5 m (28 ft) between each structure for additional space. We have the ability to cover the whole area with shade using the greenhouse and cables for support. This area is used to hold liners, as well as grow stock plants. Our normal production is taken from stock plants in the ground at the nursery. Due to the numbers required we were forced to start a 1-gal and 3-gal production area. This section is used for this type of production. We added another 232 m<sup>2</sup> (2500 ft<sup>2</sup>) of cold frame area this fall for more growing area.

Because of the large amount of heated area we installed a 100 kw diesel generator with automatic transfer for backup power. With hundreds of thousands of dollars of plant material, the \$20,000 investment was a no-brainer.

## **PRODUCTION**

Since all these products are new, we usually start with less than one hundred cuttings. With some plants we have started with one cutting. In a best-case scenario with 100% rooting we can go from 10 cuttings to 50,000 cuttings in 2 years. This means we will begin production 3–4 years before the scheduled release date.

We work closely with the managing nurseries and patent agents to determine when the liners need to be to the growers so they can finish the appropriate container size by the release date. We try diligently to get the product to the different growers all at the same time so that everybody's containers are ready at the target date.

### **Advantages of Large Quantity Production of One Genus, Species, or Cultivar are:**

- Water, light, fertility, and chemical requirements are the same in the propagation area.
- Propagation areas are filled and emptied in a more regular and predictable schedule.
- Percentage of rooting is higher with one product production per zone or house.
- A majority of the product is sold in advance.

### **Disadvantages of Large Quantity Production of One Genus, Species, or Cultivar are:**

- Winter production and high heating cost.
- Large container stock is required.

- Large amounts of cold frame and heated greenhouse space are required for holding product.
- Product is held for a long period till sufficient numbers are available to all vendors.
- The stress of knowing that everyone is counting on you. There is no backup or plan B.
- Over-production is unavoidable because under-production is unacceptable.
- You are the “one night stand” of horticulture. We are used to getting nurseries started in production and then they produce their own liners.
- Plants react differently to heating during the winter months.  
*Hydrangea macrophylla* ‘Lady in Red’ PP# 15,175 grew without problems the whole winter. The Razzle Dazzle® crape myrtle series responded poorly to no dormancy. The crape myrtles that were given cold and dormancy and then brought into the heated houses did well.  
*Hydrangea quercifolia* ‘Vaughn’s Lillie’ PP# 12982 produced zero cuttings and struggled in the spring when given constant heat and no dormancy. This was also the case with *Calycanthus* ‘Venus’ PPAF.

### TRIAL AND EVALUATION

The southeastern U.S.A. is without a doubt the hotbed of new plants and plant sales. Through years of establishing relationships with fellow nurserymen, universities, patent agents, and plant nuts, we are constantly trialing new plants. We evaluate plants from the U.S.A. and many foreign countries. We are very involved in giving information and observations about these new products. The Southern U.S.A. can be rough on many plants. What looks great in Oregon, England, or Pennsylvania does not always do well in Georgia. Griffith Propagation and our associates work very hard to test these plants to ensure they are worthy of the intense marketing necessary for them to succeed.

## A Water Quality Issue: Opportunity or Opponent?®

### Tom Yeager

Department of Environmental Horticulture, University of Florida, IFAS, PO Box 110670, Gainesville, Florida 32611

### Ken Kuhl

Florida Department of Agriculture, Office of Agricultural Water Policy, 1203 Governors Square Blvd., Suite 200, Tallahassee, Florida 32301

## INTRODUCTION

How often have you heard the phrases “don’t blame me I didn’t do it” or “it will never happen to me”? This is often our first reaction when someone communicates discomforting information and could have been the response of the nursery industry in Broward County Florida when asked by the South Florida Water Management District (SFWMD) to help reduce the concentration of total phosphorus in surface water discharged to the Everglades. The Everglades Forever Act ([http://www.sfwmd.gov/org/wrp/wrp\\_evg/projects/efa.html](http://www.sfwmd.gov/org/wrp/wrp_evg/projects/efa.html)) stipulated that water in the Everglades Protection Area should be 10 ppb total phosphorus; however, canal waters of the C-11 West Basin flowing into the Everglades Protection Area currently exceed 10 ppb.

A water quality issue similar to this could involve your nursery in the future. The publicity of environmental consequences resulting from container plant production has become more commonplace in urban and rural areas. Consequently, the nursery industry is usually confronted with the decision to ignore the situation and likely suffer the consequences of those outside the industry deciding what is best for the industry, or the industry can decide to be a participant in the solution as the industry did in Broward County Florida under the leadership of the Broward Chapter of the Florida Nursery, Growers and Landscape Association, the statewide nursery organization.

## AREA OF INTEREST

The specific area of focus by SFWMD involves the C-11 canal that flows west from Ft. Lauderdale to the Everglades. SFWMD is responsible for the maintenance of the C-11 canal. Secondary canals that flow to the C-11 canal are maintained by three drainage districts that make up the C-11 West Basin: South Broward Drainage District (SBDD), Central Broward Water Control District (CBWCD), and Indian Trace Drainage District (ITDD). The Drainage Districts encompass about 72 square miles, and land use is approximately 61% developed and 16% agriculture (Adorisio et al., 2004), primarily container and field-grown nursery plants. Wetlands, forests, and rangelands are also present. Average total phosphorus concentrations at selected locations in the C-11 West Basin canal waters for 2000-2003 are given in Table 1.

## BMP DEVELOPMENT

In early 2003, the SFWMD asked the nursery industry in Broward County to participate in developing Best Management Practices (BMPs). Subsequently, The Flor-

**Table 1.** Average total phosphorus concentrations of canal waters at selected locations in the C-11 West Basin of Broward County Florida for 2000-2003.

Drainage district	Total P (ppb)	Number of sampling locations
ITDD	16	6
SBDD	88	20
CBWCD	33	14

ITDD = Indian Trace Drainage District

SBDD = South Broward Drainage District

CBWCD = Central Broward Water Control District

Source of data <[http://www.sfwmd.gov/org/reg/esp/pdfs/esp\\_annrpt\\_2004.pdf](http://www.sfwmd.gov/org/reg/esp/pdfs/esp_annrpt_2004.pdf)>.

ida Department of Agriculture and Consumer Services (FDACS) became involved in the process because the Office of Agricultural Water Policy (OAWP) of FDACS is responsible for developing BMPs that are adopted by rule with statutory authority. The BMPs must be economically and technically feasible and developed with grower input. FDACS relies on expertise from university personnel to ensure the BMPs are research-based to the extent possible. Also, regulatory personnel of the state are involved in the BMP development process to ensure that BMPs provide the “backbone” for addressing water quality issues.

In late 2003, FDACS and the University of Florida began discussing with industry the topics that should be the subject of a BMP guide or manual. In early 2004, nursery industry personnel from south Florida agreed to lead the development of the following topics or chapters: Nursery Layout, Container Substrates and Planting Practices, Fertilization Management, Container Substrate Nutrient Monitoring, Irrigation Water Quality, Irrigation Application, Irrigation Uniformity, Erosion Control and Runoff Water Management, Pesticide Management, and Waste Management. Numerous meetings and discussions with as many nursery plant producers as possible representing Broward, Dade, and Palm Beach counties were convened along with representatives from government agencies, associations, and educators to determine the content of the chapters, which were based on the cultural practices producers were currently using or could be using that would minimize or reduce surface water nutrient movement from their nursery to adjacent canals. This process evolved into a draft document titled *South Florida Container Nursery BMP Guide* <<http://floridaagwaterpolicy.com>>. This document has a similar format to *Best Management Practices Guide for Producing Container-Grown Plants* printed by the Southern Nursery Association that provided background information for the chapter leaders and nursery industry participants who developed the document for south Florida. The *South Florida Container Nursery BMP Guide* will be used by container plant producers to determine “how to” comply with water quality standards by assessing their nursery and marking in the guide those practices they are currently using and those practices they commit to implement. Thus, they have a plan that, once implemented, along with keeping required records, qualifies the nursery for a waiver of state-imposed liability for surface and ground water cleanup and presumption of compliance with state water quality standards.

## EDUCATION

Workshops have been conducted in several locations in south Florida to assist nursery operators with implementation of BMPs. The workshop format enables hands-on experiences with calculation of irrigation uniformity, substrate physical property determination, and measuring container substrate nutritional levels. Workshop participants also conduct an assessment of BMPs at a nursery.

Based on: (1) nutrient data collected previously from canal waters, (2) the physical infrastructure of a nursery, or (3) the willingness of owner to cooperate, nurseries have been selected to demonstrate BMPs. For example, implementation of a grassed water conveyance area or runoff water collection structure would trap or allow suspended sediments in water to flocculate, thus cleaning the water before discharge to the canal. Data will be collected to verify the effectiveness of the grassed waterway and collection structure. Interested persons will be able to view the demonstration and learn about the effectiveness of the BMPs during field days conducted by University of Florida Extension.

## ASSISTANCE

Some nursery operations are currently using many of the BMPs in the draft document, but others will need to change or implement new practices. Change is not easy psychologically and can also be costly. To help defray some costs, a cost share program has been established in which 80% of the costs of construction for a BMP can be paid for by Palm Beach Soil and Water Conservation District (PBSWCD). The cost share program is administered by PBSWCD with funding provided by FDACS and SFWMD. The first year \$400,000 was available for cost share, with \$320,000 proposed for each of the two subsequent years. To assist nurseries with the decisions about which BMPs to implement, a mobile irrigation lab funded by FDACS is conducting site visits. For example, the mobile irrigation lab staff might conduct an irrigation uniformity test and suggest improvements that can be cost shared by the nursery.

## CONCLUSION

Does your nursery impact surface water quality? You may not know the answer at this time, but surface water quality criteria for nutrients are being established for the natural waters of the states as specified by the Federal Clean Water Act of 1972. Consequently, surface water issues for nurseries are likely in the future and can be addressed by working together, as indicated by what has happened in response to elevated phosphorus concentrations in the canals in Broward County. Our future will depend on how well agencies, industry, universities, and associations work together, not only to confront and solve the water quality issues, but to leap forward using new production technology. We can make it happen!

**Acknowledgement.** The University of Florida gratefully acknowledges the financial support of the Office of Agricultural Water Policy, Florida Department of Agriculture and Consumer Services, Tallahassee, Florida.

## LITERATURE CITED

- Adorasio, C., D. Meiers, P. Sievers, B. Powell, C. Miessau, and E. Marshall. 2004. Everglades storm water program basins source control schedules and strategies. <[http://www.sfwmd.gov/org/reg/esp/pdfs/esp\\_annrpt\\_2004.pdf](http://www.sfwmd.gov/org/reg/esp/pdfs/esp_annrpt_2004.pdf)>. Accessed on 28 Nov. 2005.
- Everglades Forever Act. The 2000 Florida statutes. <[http://www.sfwmd.gov/org/wrp/wrp\\_evlg/projects/efa.html](http://www.sfwmd.gov/org/wrp/wrp_evlg/projects/efa.html)>. Accessed 28 Nov. 2005.

## Bouncing Back: Lessons Learned from Hurricanes®

### Tacy Callies

Ornamental Outlook, 1555 Howell Branch Rd., Suite C-204, Winter Park, Florida 32789

### INTRODUCTION

According to weather experts, 1995 marked the start of a new cycle of increased hurricane activity that is predicted to last for 30 years. If the 2004 and 2005 Atlantic hurricane seasons are any indication of this trend, the bad news is that we've got 20 more years to go. The good news, however, is that there are plenty of steps we can take to help protect our businesses.

### LESSON #1: EXPECT THE UNEXPECTED

Hurricanes can and do change course. This can happen long before they hit land or just before they hit land. University of Florida Extension Agent Laura Miller describes the cone of error as more of a giant basketball of error. Hopefully, we have all learned by now to prepare if we are anywhere in the shaded region, not just directly in the path of the little black line. Sitting back and hoping for the best is not an acceptable strategy.

In 2004, Hurricane Charley took an unexpected turn and hit Port Charlotte instead of Tampa Bay. In 2005, Hurricane Katrina dipped south in the eleventh hour, striking the unprepared Homestead area. In both cases, growers were caught off guard.

Many thought a Category 1 storm wouldn't do much damage. They were wrong. When Hurricane Katrina hit South Florida as a Category 1, it caused estimated damages of \$370 million to nurseries. The lesson learned here is to be prepared and treat all hurricanes as a serious threat, no matter what category they are.

### LESSON #2: INSURE 'TIL IT HURTS

After the hurricanes, many growers found themselves woefully underinsured. To prevent this from happening, keep your insurance policies updated. Know exactly what your policy does and does not cover. Meet with your insurance agent annually at your nursery so that any changes or additions to structures and equipment can be examined and adequately covered. Buy the most coverage you can afford.

Read your policy and ask questions if you don't fully understand it. Know what coverage you are buying, what your deductibles are, and if your coverage is enough to get you back in business in case of a catastrophe. Understand how your structures (especially greenhouses) are valued. For example, if actual cash value is used, buildings are valued on their useful life, not their replacement cost.

Know how poly is treated. Some carriers don't include coverage for soft roofs. Others cover them on an actual cash-value basis, which could be as short as 3 years. Many growers recommend cutting poly to save houses, but check with your insurance company. For example, Hortica makes no recommendations regarding cutting poly and says that cutting poly is done at the insureds' discretion and risk. If an insured grower cuts the poly, and the storm would not otherwise have damaged it, Hortica will not pay for the poly covering or resulting damages.

Make sure you have adequate personal property insurance coverage. At peak times of the year, pot, sleeve, basket, and tag values may be considerably higher than reported on your policy.

Consider co-insurance. If your building is insured for less than it would cost to rebuild it, you could be penalized by the percentage you are underinsured. You don't need to experience a complete loss for co-insurance to take effect. Be sure to value your buildings based on what it would cost to replace them in today's market.

Business insurance can protect you from loss of business and profits in the event that you are out of business for an extended period of time.

The federal nursery crop insurance policy period recently changed from Oct. 1–Sept. 30 to June 1–May 31. The most current updates to the policy can be viewed online at [www.rma.usda.gov/regs/05nurseryfinalrule.pdf](http://www.rma.usda.gov/regs/05nurseryfinalrule.pdf). The following are important policy points to remember:

- The policy carries a yearly cumulative deductible, not a per-occurrence deductible.
- Growers can buy a new policy up to 30 days before the end of the crop year.
- Crop insurance includes 15 basic units for container crops. Each unit stands on its own for deductibles and coverage levels — as long as you buy up to a higher coverage level than catastrophe.
- Catastrophe coverage levels range from 27% to 75% of total values.
- Different coverage levels can be purchased for container- and field-grown crops.
- Container-grown palms and cycads have been added to the policy.
- Liners, down to 1 inch in diameter, have also been added to the policy. Note, however, that not all 288 cells are 1-inch wide! So be sure to measure your cells to know if they're covered.
- A new coverage option for field-grown nurseries called the Rehabilitation Endorsement pays up to 7.5% of values for the labor to stake, tie, or reposition trees damaged by an insured cause of loss. A loss of 2% or \$5,000 is required for payment.

### LESSON #3: PREPARE YOUR NURSERY

Items to stockpile prior to hurricane season include spare irrigation parts, fuel, water, stakes, poly, building materials for structural repairs, potting soil, and fungicides. Make sure you have enough generator power to run pumps and other vital operations. According to Paul Moellering of Stateline, an affiliate of Tradewinds Corporation, some insurance carriers will not insure an agricultural operation without a sufficient standby power source. He also advises that it is more cost effective to add kilowatts when you purchase a generator than to try to add more later on. He recommends working with an electrician to determine the size and type of generator that's right for your operation. Keep generators properly maintained and test them at least twice per year to make sure they are working. The most important maintenance is the first oil change, recommended just 50 h after initial use. Yearly oil changes and new filters should keep your generator running smoothly.

Create a list of emergency numbers, including crop and property insurance agents, your local Farm Service Agency office, and local police, fire, and utility companies.

Other essential steps in preparing your nursery for a hurricane include the following:

- Inventory your plants and equipment.
- Charge cell phone and other batteries.



- Water plants fully prior to a storm and lay potted plants 3 ft or taller down — parallel to the expected wind direction.
- Secure all loose items, such as pots, heaters, and other equipment, that could become airborne.
- Remember to protect your computers and other valuable office equipment.
- Print out payroll and inventories.
- Park trailers side-by-side to prevent tumbling.
- Turn off utilities prior to evacuation.

Immediately after a hurricane, photograph and document all damage before you clean up. Include labor-related costs directly related to storm preparation and recovery.

#### **LESSON #4: PREPARE YOUR STAFF**

Allow time for your employees to secure their homes prior to a storm. Let your labor know what shelters are available. Let them know what you expect of them after the storm. Do you want them to come to work, to call you, or to stay with their families?

#### **LESSON #5: AID AWARENESS**

Knowing the basics of disaster assistance programs available through USDA's Farm Service Agency (FSA) can save time and frustration. Here is a brief overview:

The Emergency Conservation Program (ECP) provides cost-share assistance to rehabilitate agricultural land damaged by natural disasters. Participants receive up to 75% of the costs to implement approved ECP practices.

Florida Representative Mario Diaz-Balart introduced a bill in October 2005 called the Nursery and Tropical Fruit Producer Relief Act (H.R. 4031). If passed, it would make shade house and greenhouse debris eligible for cost-share assistance under ECP and would allow ornamental tree growers to be eligible for cost-share assistance under the Tree Assistance Program (TAP).

Currently, TAP only covers crop-producing trees like fruit and nut trees, not ornamental trees.

To be eligible for the Crop Disaster Assistance Program, producers must have suffered greater than 35% production loss and/or more than 20% quality loss. Producers must be in compliance with highly erodible land conservation and wetland conservation provisions. Adjusted gross income (AGI) must not exceed \$2.5 million, unless more than 75% percent of the AGI is from farming, ranching, and forestry. There is an \$80,000 per person payment limitation. Note that "person" can mean many things, including an individual, a limited liability partnership, a limited liability company, a corporation, etc. Persons that received payments under the Florida Disaster Programs are not eligible for Crop Disaster Assistance payments for the same loss.

The Noninsured Crop Disaster Assistance Program provides financial assistance to producers of noninsurable crops when low yields, loss of inventory, or prevented planting occurs due to natural disasters. To be eligible, annual gross revenue cannot exceed \$2 million. The natural disaster must have either reduced the expected unit production of the crop by more than 50% or prevented the producer from planting more than 35% of their intended crop acreage. The noninsured Crop Disaster Assistance Program covers the amount of loss greater than 50% of the expected production, based on the approved yield and reported acreage.

Emergency Loan Assistance is another FSA program. The loan limit is up to 100% of actual production or physical losses, to a maximum amount of \$500,000. The interest rate is 3.75%.

Applications must be received within 8 months of a county's disaster designation date; see <<http://disaster.fsa.usda.gov/>> for more details on FSA programs.

## LESSON #6: THE TRUTH ABOUT TREES

After the hurricanes, many observations were reported on what trees held up well to the wind and what trees didn't. The University of Florida's Ed Gilman lists the best performers as palms (except queens), live oaks, Southern magnolias, hollies, and bald cypress. John Davy of Panhandle Growers says multi-trunk crape myrtles, most magnolias (except 'D.D. Blanchard'), hollies, bald cypress, and sweetgums fared well. According to Soaring Eagle Nursery, Phoenix palms held up to winds better than any other group of palms. Gumbo limbos, sea grapes, and loblolly pines also held up well. Other best performers, per Pamela Crawford in her *Storm-scaping* book, include dogwood, ironwood, Japanese maple, red bay, redberry stopper, Spanish stopper, white stopper, and sand live oak.

Gilman saw the worst damage in laurel oaks, red oaks, hickories, mahogany, southern red cedar, and peltophorum. Crawford ranks the three worst trees as Australian pines, *Ficus benjamina*, and laurel oaks. Lloyd Singleton, landscape manager at The Breakers in Palm Beach, notes that half his coconut palms died within the first month after the second hurricane last year; the rest died in spring with the new flush of growth.

Whether a tree was native or non-native seems to have not played a role in how trees fared.

Infusion of salt into the groundwater and roots of many trees could cause damage such as leaf drop or scotched foliage that may not be evident until spring, says Gilman. He recommends soil testing for salinity. If high, consider irrigation to wash the excess salt through.

According to Gilman, species is a relatively small factor in determining tree failure. Important factors include shallow water table, soil compaction, root cutting, girdling roots, presence of co-dominant stems, bark inclusions, planting trees in small spaces, planting too deep, poor ability to compartmentalize decay, and pruning history. In a University of Florida study, Cathedral oaks that had all their low branches removed had a greater lean after the hurricanes. However, oaks with long, low branches did not display any amount of lean and were firmer in the soil after the storms.

## LESSON #7: SILVER LININGS

Despite all of the pain they inflict, hurricanes can bring some good. After the storms have passed, landscapes need replacement and there is strong market demand for plants. Hurricanes give us a reason to grow and sell more plants. In addition, downed trees create more full-sun landscapes, providing greater opportunities for color.

According to Florida Nursery, Growers & Landscape Association Executive Vice President Ben Bolusky, there is a political silver lining to the storms. He says that state and national legislators now have the ornamental horticulture industry clearly on their radar screens and realize its importance to the economy.

## RECOMMENDED RESOURCES

- USDA's Farm Service Agency Disaster Assistance, <<http://disaster.fsa.usda.gov/fsa.asp>>.
- Storm Preparation and Dealing with the Aftermath—includes information from University of Florida, University of Georgia, and The National Arbor Day Foundation, <<http://hort.ufl.edu/woody/stormprep.htm>>.
- Florida Nursery, Growers & Landscape Association—hurricane tips and information, <[www.FNGLA.com/hurricane/default.asp](http://www.FNGLA.com/hurricane/default.asp)>.
- *Ornamental Outlook* — Bouncing Back, <[www.ornamentaloutlook.com](http://www.ornamentaloutlook.com)>.
- *Stormscaping: Landscaping to minimize wind damage in Florida* by Pamela Crawford.
- Hurricane preparedness list for nurseries by Tom Yeager, <<http://edis.ifas.ufl.edu/EP076>>.
- Post-hurricane Considerations for the Commercial Nursery by Tom Yeager, <<http://edis.ifas.ufl.edu/EP065>>.

## LITERATURE CITED

- Allen, M. 2004. Persistent palms. *Ornamental Outlook*. 13(11):20-21.
- Allen, M. 2004. Replant, restore, recover. *Ornamental Outlook*. 13(12):24-25.
- Bolusky, B. 2005. Industry recovery. *Ornamental Outlook*. 14 (9):58.
- Calkins, B. 2005. Generating peace of mind. *Ornamental Outlook*. 14(3):27.
- Callies, T. 2005. Sunbulb rebuilds. *Ornamental Outlook*. 14(3):30.
- Crawford, P. 2005. *Stormscaping: Landscaping to minimize wind damage in Florida*. Color Garden Inc., Lake Worth, Florida.
- Funk, J. 2004. Picking up the pieces. *Ornamental Outlook*. 13 (11):6-7.
- Funk, J. 2005. Reviving the landscape. *Ornamental Outlook* 14 (2):25-26.
- Nelson, B. 2005. Protect your property. *Ornamental Outlook* 14 (5):20.
- Nelson, B. 2005. Crop insurance changes. *Ornamental Outlook*. 14 (8):37-38.
- Padrick, R. C. 2005. Aid on the way. *Ornamental Outlook*. 14 (4):42.